

**ERITECH<sup>®</sup>**

# Grounding & Bonding

For Electrical Systems



**ERICO<sup>®</sup>**

# ERICO®

Founded in 1903 as the Electric Railway Improvement Company, ERICO developed the CADWELD® exothermic welding process in 1938. CADWELD connections have found industry-wide acceptance as the ultimate grounding and bonding connection. During the 1970s, ERICO pioneered the copper-bonded steel ground rod electrode. Today, ERICO's range of facility electrical protection products includes ERITECH® ground rods, grounding clamps and accessories, electrical bonding products, ground enhancement material, ground testers, lightning protection components, equipotential mesh and mats, and signal reference grids; low-voltage surge protection devices; and CADWELD® exothermic connections.

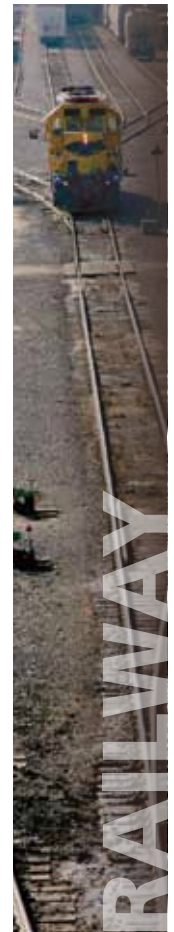
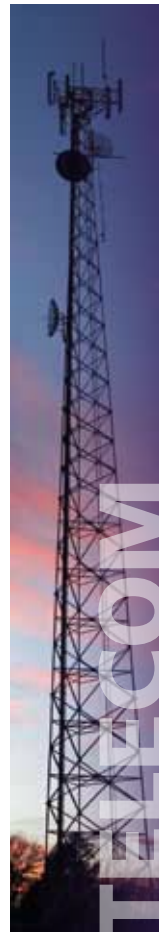

## Facility Electrical Protection

Lightning protection, grounding, equipotential bonding and surge protection are all interdependent disciplines and the focus of the ERITECH® brand of facility electrical protection products. Reliable protection of personnel and structures demands a systematic and comprehensive approach to minimizing threats caused by transients and other system disturbances. For instance, no air terminal can safely capture and arrest the lightning energy without a dependable route to ground. Equally, even the most expensive surge protection device (SPD) will not provide optimum protection if a low-impedance electrical connection to the ground is not present. Additionally, a low-impedance ground system may create hazards to equipment and personnel alike if equipotential bonding is not in place. These interdependent disciplines are best applied when looking at a total facility rather than an individual piece of equipment or a portion of the facility.

Since no single technology can eliminate the harmful effects of lightning or induced-surge transients, ERICO has developed the Six Point Plan of Protection. The concept behind this plan is a holistic and coordinated approach that embraces all aspects of effective facility electrical protection.

## The six interdependent disciplines that form the protection plan are:





1. Capture the lightning strike
2. Convey this energy to ground
3. Dissipate energy into the grounding system
4. Bond all ground points together
5. Protect incoming AC power feeders
6. Protect low voltage data/telecommunications circuits

At ERICO, we offer innovative, efficient grounding and bonding products as well as engineering experience and technical support. With this experience, ERICO is a world-leading authority in the design and construction of permanent, low-impedance grounding systems.

ERICO employs a quality-assurance program to help ensure that detailed procedures required for every step of the operation produce the best possible system for our clients. This attention to detail includes design, materials procurement, manufacturing, installation and testing.

Our research and development capabilities provide continuous design improvement with new and improved products that preempt the challenging requirements of ever-evolving industry applications. Engineering expertise is shared among the other ERICO operations worldwide, to provide a comprehensive global knowledge pool.



	<b>Grounding Principles .....</b>	<b>2 – 10</b>
	<b>Grounding System Components .....</b>	<b>11 – 28</b>
	Ground Conductors.....	12 – 13
	Ground Rods and Couplers.....	14 – 17
	Ground Clamps and Connectors.....	18 – 23
	Chemical Ground Electrodes.....	24 – 25
	Ground Enhancement Material.....	26 – 29
	Grounding Accessories .....	30
	Ground Plates.....	31 – 32
	<b>Equipotential Bonding.....</b>	<b>33 – 62</b>
	Grounding Bus Bars.....	34 – 37
	Telecom Ground Bars.....	38 – 39
	Perimeter Grounding Bus Bars .....	40 – 41
	Equipment Ground Plates.....	42
	Equipment Ground Plate Assemblies.....	43
	Aircraft Grounding Receptacles .....	44
	Signal Reference Grids.....	45 – 49
	Equipotential Mesh and Mats .....	50 – 53
	Bonding Devices.....	54 – 55
	Copper Bonding Straps .....	56 – 57
	Fence Clamp Assemblies .....	58 – 60
	Static Grounding and Bonding.....	61 – 62
	<b>Ground Resistance Testers.....</b>	<b>63 – 65</b>
	Ground Resistance Testers .....	64 – 65
	<b>Technical Information .....</b>	<b>66 – 68</b>

CADWELD® is an exothermic welding system for developing permanent welded electrical connections that will never loosen, corrode or increase in resistance. High-quality CADWELD connections are an integral part of the grounding and bonding process. Contact an ERICO representative today to request additional information on CADWELD.

# Grounding Principles



## Introduction

Grounding and bonding are an integral part of any modern electrical protection system design.

An effective, low-impedance ground system is a key element of this system. It is crucial to help provide personnel safety, as well as reliable protection for vital equipment and to minimize interruptions of service and costly downtime.

With over a century of experience in the design and manufacture of bonding and grounding products, ERICO, a single source provider, offers what we believe is the best range of long lasting and cost-effective grounding products available.

Soil conditions and seasonal patterns vary from site to site, the methods of grounding need to be considered on an individual basis.

## Basic Definitions

**Ground:** A conducting connection, whether intentional or accidental, between an electrical circuit or equipment and the earth, or to some conducting body that serves in place of the earth.

**Earth:** The conductive mass of the earth, whose electric potential at any point is conventionally taken as equal to zero. (In some countries the term "ground" is used instead of "earth.")

**Bonding:** The permanent joining of metallic parts to form an electrically conductive path that will ensure electrical continuity and the capacity to conduct any current likely to be imposed.

### ***The need to ground!***

There are important reasons why a grounding system should be installed.

- 1 The most important reason is to help protect people!
- 2 To help provide protection of structures and equipment from unintentional contact with live conductors.
- 3 To help support maximum safety from electrical system faults and lightning.

It is a fundamental fact that electricity **ALWAYS** flows to the point of lowest potential. The task is to help ensure that electricity, including faults, lightning and electronic noise, flows to this point with maximum safety to people, while maintaining the reliability of equipment. Therefore we must help ensure the safe, controlled flow of electricity with minimum voltage drop to earth in all cases.

## Grounding Codes and Standards

Grounding needs vary according to function. The grounding requirements of a power system will vary from those of electrical equipment, lightning protection or for the proper function of electronic equipment.

Proper installation of appropriate grounding systems requires knowledge of the needs and layout of the facility. Soil characteristics, grounding conductor materials grounding connections and terminations, ***are significant factors determining the design of a grounding system. Applicable standards and codes must be applied.***

While many codes and standards contain minimum grounding and bonding requirements, the design and installation of electrical grounding systems is one of the most important aspects of any electrical distribution system. However, codes and standards are often misunderstood and grounding systems subsequently installed improperly.



## Why is Good Grounding Important?

The transient nature of lightning with its associated fast rise times and large magnitude currents mean that special consideration needs to be given to grounding, for lightning protection to be effective. Many factors such as soil resistivity variations, installation accessibility, layout and existing physical features are all site specific and tend to affect decisions on grounding methods employed. The primary aim of a direct strike grounding system is to:

- Efficiently dissipate lightning energy into the ground
- Help protect equipment and personnel

## Grounding Principles

Low impedance is the key to lightning protection. All grounding connections should be as short and direct as possible to minimize inductance and reduce peak voltages induced in the connections. The ground electrode system must efficiently couple lightning surges into the ground by maximizing capacitive coupling to the soil. The resistance of the ground itself to lightning currents must also be minimized. Only when all these factors are taken into account will maximum lightning protection be achieved.

## Ground Impedance

Soil resistivity is an important design consideration. It varies markedly for different soil types, moisture content and temperatures and gives rise to variations in ground impedances.

## Short, Direct Ground Connections

The voltage generated by a lightning discharge depends primarily on the risetime of the current and the impedance (primarily inductance) of the path to ground. Extremely fast rise times result in significant voltage rises due to any series inductance resulting from long, indirect paths, or sharp bends in the routing of ground conductors. This is why short, direct ground connections are important.

## Coupling from the Electrode System to the Ground

The efficiency of a ground electrode system in coupling a lightning current to ground is dependent on a number of factors, including the geometry of the ground electrode system, the shape of the conductors and the effective coupling into the soil.

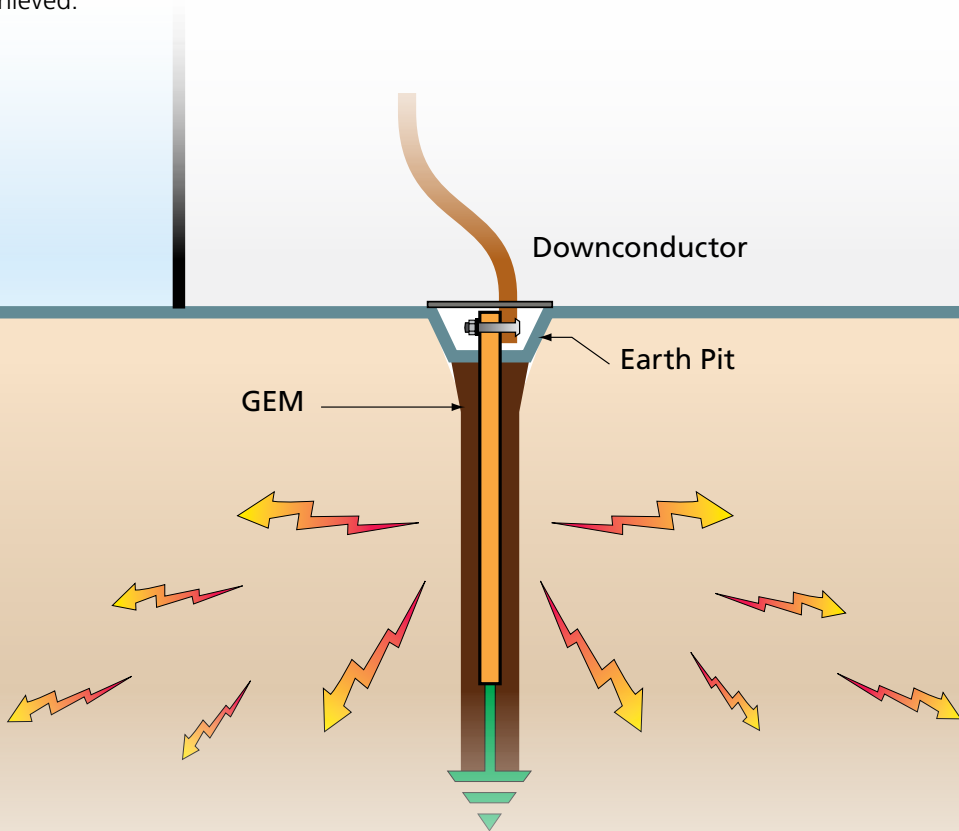

A typical grounding system.

# Grounding Principles

Figure 1-A

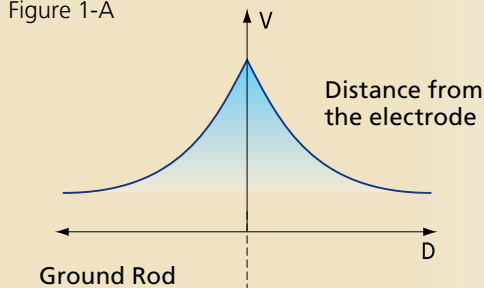
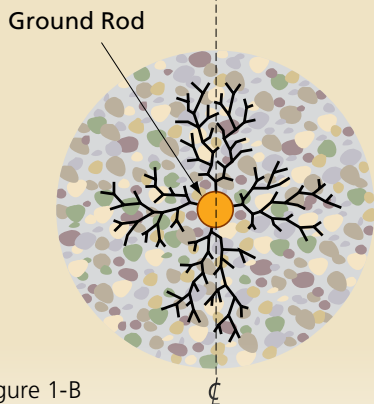

Figure 1-B



**Figure 1-B** illustrates current flow from the injection point of a single ground electrode. As current flows out from the central injection point, a voltage gradient on the ground surface around the electrode is produced. This gradient levels off to a plateau at some distance from the electrode, as seen in **Figure 1-A**. The impedance seen by the current is determined by the soil particles in direct contact with the surface of the rod, and by the general impedance of the soil.

## Characteristics of a Good Grounding System

- **Good electrical conductivity**
- **Conductors capable of withstanding available electrical fault currents**
- **Long life — at least 40 years**
- **Low ground resistance and impedance**

*The basic philosophy of any grounding installation should be an attempt to maximize the surface area of electrodes or conductors with the surrounding soil. Not only does this help to lower the earth resistance of the grounding system, but it also greatly improves the impedance of the grounding system under lightning surge conditions.*

## • Equipotential bonding

*Equipotential bonding helps ensure that hazardous potential differences do not occur between different incoming conductors such as metallic water services, power systems, telecommunication systems and the local ground, and also minimizes step and touch potentials.*

## • Good corrosion resistance

*The ground electrode system should be corrosion resistant, and compatible with other conductors that are buried and bonded to the ground system. Copper is by far the most common material used for grounding conductors. In general, some form of maintenance or inspection procedure should be adopted to ensure the long-term effectiveness of a grounding system.*

## • Electrically and mechanically robust and reliable

*Mechanical coupling can be used to join ground conductors, but suffers from corrosion effects when dissimilar metals are involved. As well as mechanical strength, CADWELD® connections provide excellent low impedance, long life electrical connections with excellent corrosion resistance.*

## Ground Resistance

When current flows from a ground electrode into the surrounding soil, it is often described as flowing through a series of concentric shells of increasing diameter.

Each successive shell has a greater area for current flow and consequently, lower resistance. At some point distant from the earth conductor the current dissipation becomes so large and current density so small, that the resistance is negligible.

In theory, the ground resistance may be derived from the general formula:

$$R = \rho \frac{L}{A} \quad \text{Resistance} = \text{Resistivity} \times \frac{\text{Length}}{\text{Area}}$$

This formula illustrates why the shells of concentric earth decrease in resistance the farther they are from the ground rod:

$$R = \text{Resistivity of Soil} \times \frac{\text{Thickness of Shell}}{\text{Area}}$$

In the case of ground resistance, uniform earth (or soil) resistivity throughout the volume is assumed, although this is seldom the case in nature. The equations for systems of electrodes are very complex and often expressed only as approximations. The most commonly used formula for single ground electrode systems, developed by Professor H.R. Dwight of the Massachusetts Institute of Technology, is the following:

$$R = \frac{\rho}{2\pi L} \left\{ (\ln \frac{4L}{r}) - 1 \right\}$$

R = resistance in ohms of the ground rod to the earth (or soil)  
 L = grounding electrode length  
 r = grounding electrode radius  
 ρ = average resistivity in ohms-cm.



## Conditions Influencing Soil Resistivity

The resistance of the earth itself (soil resistivity) can significantly impact the overall impedance of the grounding system. Several factors, such as soil composition, moisture content, mineral content, contaminants, etc., determine the overall resistivity of the earth.

SOIL TYPE	Resistivity ohm-cm		
	Average	Min.	Max.
Fills – ashes, cinders, brine wastes	2,370	590	7,000
Clay, shale, gumbo, loam	4,060	340	16,300
Clay, shale, gumbo, loam with varying proportions of sand and gravel	15,800	1,020	135,000
Gravel, sand, stones, with little clay or loam	94,000	59,000	458,000

U.S. Bureau of Standards Technical Report 108

## Soil Resistivity Testing

To properly design a grounding system, it is essential to test soil resistivity. Several methods can be used to measure earth resistivity: the four-point method, the variation in-depth method (three-point method) and the two-point method. The most accurate method and the one that ERICO recommends is the four-point method.

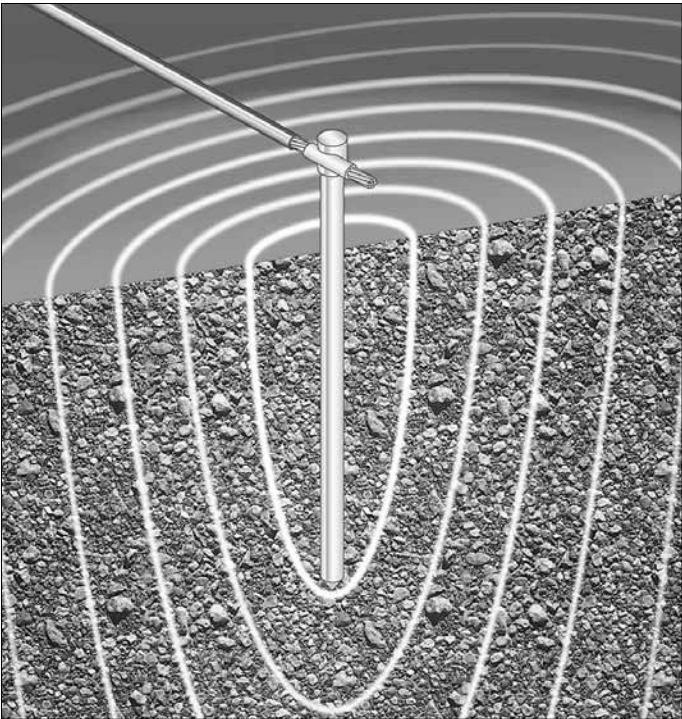

Sphere of Influence - electrical current flows from the ground rod into surrounding soil and progressively dissipates in waves of increasing diameter.

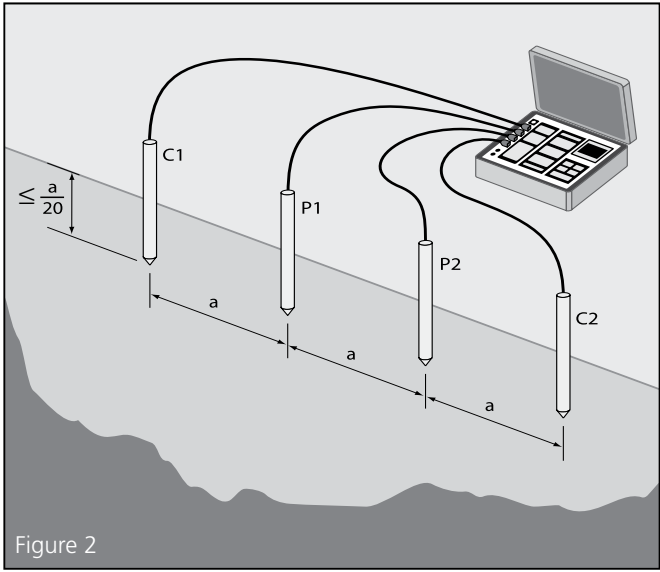

Figure 2

## The Four-Point Method

- Four test stakes are positioned in a straight line an equal distance apart and are hammered into the ground to be surveyed to a depth of not more than 1/20 the distance between the adjacent stakes.
- An earth resistance tester is connected to these four stakes as shown in Figure 2.
- The DC test option on the tester is then selected and performed, and the resistance figure "R" recorded.
- The soil resistivity level "r" (in ohms/cm) is then calculated using the formula:  $r=2\pi aR$  where:  
R = the resistance figure, in ohms  
a = the separation of the test stakes, in meters.

$$p = \frac{4\pi AR}{1 + \frac{2A}{\sqrt{(A^2 + 4B^2)}} - \frac{2A}{\sqrt{(A^2 + 4B^2)}}$$

Where:

A = distance between the electrodes in centimeters

B = electrode depth in centimeters

If  $A > 20 B$ , the formula becomes:

$$p = 2\pi AR \text{ (with A in cm)}$$

$$p = 191.5 AR \text{ (with A in feet)}$$

$$p = \text{Soil resistivity (ohm-cm)}$$

This value is average resistivity of the ground at a depth equivalent to the distance "A" between two electrodes.

# Grounding Principles



Avoid hazardous Step and Touch Potentials (shock) or even death by low impedance grounding and bonding between metallic equipment, chassis, piping, and other conductive objects so that currents, due to faults or lightning, do not result in hazardous voltage rise.

## Step and Touch Potential

### Step Potential

Step Potential is the voltage difference between a person's feet caused by the dissipation gradient of a fault entering the earth.

### Touch Potential

Touch Potential is similar to "Step Potential" except that the fault current passes through the person's arm and torso on the way to the ground.

Another function of the grounding system is to provide a reference for circuit conductors to stabilize their voltage to ground during normal operation. The earth itself is not essential to provide a reference function; another suitable inductive body may be used instead.

The function of a grounding electrode system and a ground terminal is to provide a system of conductors, which ensures electrical contact with the earth.

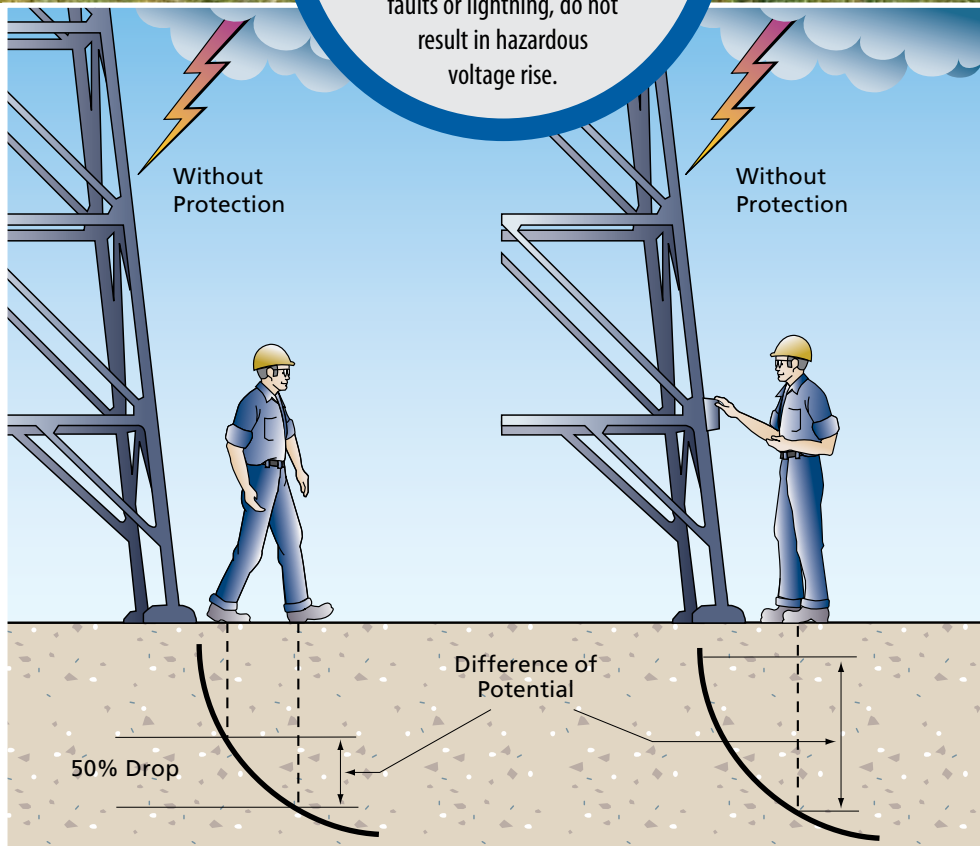

GROUNDING PRINCIPLES  
TECHNICAL INFORMATION





## Grounding / Earthing System Design

Grounding systems are important. It is not expensive to build an appropriate ground system during initial construction of a facility, but it can be very expensive to add to it, enhance it, or replace it after the facility is complete. Care should be taken to design a system that is appropriate both for clearing ground faults and dissipating lightning energy. The system must have a long performance life, meet applicable codes / standards for safety, and have sufficient bonding points to make it easy to add new equipment / facility grounding to it easily.

### Design considerations include:

- Purpose of facility
- Design life of facility
- Soil resistivity at 3 depths
- Corrosive nature of soil
- Shape and available area of facility site
- Existing structures and their grounding systems
- Seasonal variations in moisture and temperature for facility site
- Public access & personnel use
- Adjacent facilities and electrical systems
- Future uses, additions, equipment for facility

For proper operation of overcurrent devices, it is important to have a low DC ohmic resistance to remote earth. In many instances, this is best achieved by installing a deep ground electrode on site. It should be driven deep enough to reach the permanent water table.

For dissipation of direct or indirect lightning currents, it is better to have many horizontal ground conductors in the soil, preferably in a radial array. This provides a low impedance path of dissipation to the high frequency component of the lightning energy.

For personnel, particularly where people congregate or where equipment operators will be located, it is important to have a grid system or other equipotential plane to reduce "step potential" and have equipment and metal structures bonded to the ground system to reduce "touch potential".

A proper facility grounding system incorporates these necessities in the most cost-effective manner that will last for the design life of the facility.

ERICO is a manufacturer and marketer of grounding, bonding, lightning protection and surge protection products and systems. ERICO has many knowledgeable and experienced engineers on staff with the training and the tools (including some of the latest design software) to design appropriate grounding systems. These engineers can assist facility owners, engineers and contractors in designing the most appropriate system for the facility in question.

### Grounding Chain

1. Grounding Electrode Conductor
2. Grounding Connections
3. Grounding Electrode
4. Electrode to Soil Resistance
5. Soil



# Grounding Principles

## The Grounding Chain

The performance of the grounding system is determined by the quality of the following five components all of which are of equal importance.

1. The Grounding Electrode Conductor. Typically made from copper or copper-bonded steel, the grounding electrode conductor must be large enough to withstand the maximum available fault current over the maximum clearing time.
2. The Grounding Connections. Often overlooked, the grounding connections are used to tie the elements of the electrode system together. Exothermically welded connections provide a molecular bond that will never loosen or corrode. Mechanical connectors, such as crimp, bolted, and wedge type, rely on physical point-to-point surface contact to maintain the integrity of the electrical connection. IEEE® Standard 837 provides detailed information on the application and testing of permanent grounding connections. ERICO can provide an independent, third-party test report evaluating the performance of these connectors in accordance with the testing procedures set forth in IEEE 837 Standard for Qualifying Permanent Substation Grounding Connections.
3. The Grounding Electrode. The grounding electrode provides the physical connection to the earth and is the instrument used to dissipate current into it. There are two main types of electrodes. "Natural" electrodes are intrinsic to the facility and include metal underground water pipe, the metal frame of the building (if effectively grounded), and reinforcing bar in concrete foundations. "Made" electrodes are installed specifically to improve the performance of the ground system and include wire meshes, metallic plates, buried copper conductor and rods or pipes driven into the ground. The ground rod is the most widely used electrode.
4. Electrode to Soil Resistance. Amount of rod surface and rod replacement are the controlling factors. Doubling diameter reduces resistance by only 10% and is not cost effective. Doubling rod length, however, theoretically reduces resistance by 40%. The most common solution is proper placement of multiple rods that are driven to the required depths.
5. The Soil. The soil resistivity, measured in ohm-centimeters or ohm-meters, plays a significant role in determining the overall performance of the grounding system and must be known before a proper grounding system can be engineered. Measuring soil resistivity allows the design engineer to locate an area with the most conductive soil



and to determine the depth of the conductive soil so that electrodes can be placed accordingly.

The grounding system will carry little or no current for long periods of time until a fault occurs or a lightning strike or other transient requires dissipation. At that point, the grounding system components will be expected to perform like new while conducting large amounts of current. Most of the grounding system is concealed below grade, making inspection of the grounding components difficult or impossible. The underground environment is a harsh one. The initial selection of the components used in the grounding system is of critical importance to its long-term effectiveness.

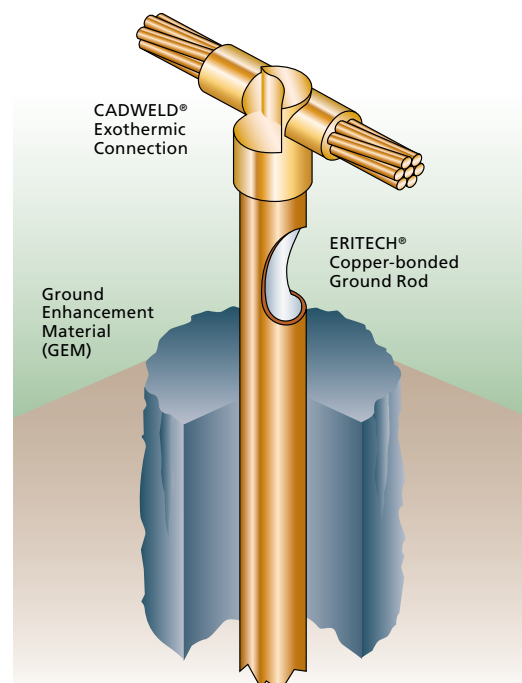

## Ground Electrodes

The ground electrode is a critical component of the grounding system. Many different types of electrodes are available, some “natural” and some “made”. The natural types include metal underground water pipe, the metal frame of a building (if effectively grounded), a copper wire or reinforcing bar in a concrete foundation or underground structures or systems. Consideration should be given to bonding of natural earths to ensure electrical continuity with a facility’s other “earth”.

“Made” electrodes are specifically installed to improve the system grounding or earthing. These earth electrodes must ideally penetrate into the moisture level below the ground level to reduce resistance. They must also consist of metal conductors (or a combination of metal conductor types), which do not corrode excessively for the period of time they are expected to serve. Made electrodes include rods or pipes driven into the earth, metallic plates buried in the earth or a copper wire ring encircling the structure. Underground gas piping or aluminum electrodes are NOT permitted for use as ground electrodes.

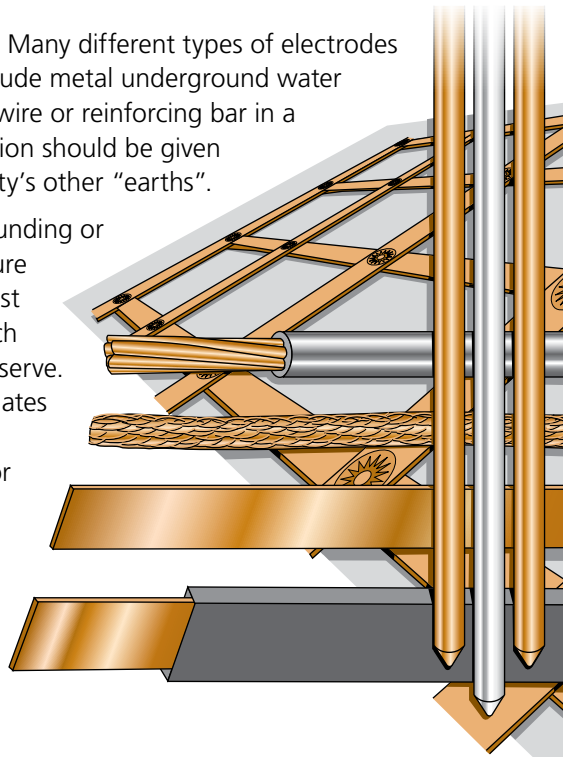

## Ground Rods - Which ground rod should be used?

Ground rods are often selected on the basis of their resistance to corrosion. The other major factor is cost. All too often, the cost of a product is seen as the initial up front price, but the real cost is determined by the serviceable life of the ground rod.

Galvanized steel rods are one of the cheapest electrodes available. However, they are not the most cost effective since they have a relatively short service life. Solid copper and stainless steel rods have a long service life. However, they are considerably more expensive than galvanized steel rods. In addition to this, solid copper rods are not suited to deep driving or even driving short lengths into hard ground, without bending.

Ask for the ERICO White Paper on Ground Rods – Copper-bonded vs. Galvanized.



The photo shows two ground rods subjected to the same pressure load test. The ERITECH® copper-bonded ground rod, shown on the left, will bend without tears, cracks or folds, to the outer sheath. The inferior copperclad rod shown on the right, has developed cracks and creases to the outer sheath, which will significantly reduce its serviceable life and put the integrity of the entire electrode at risk.

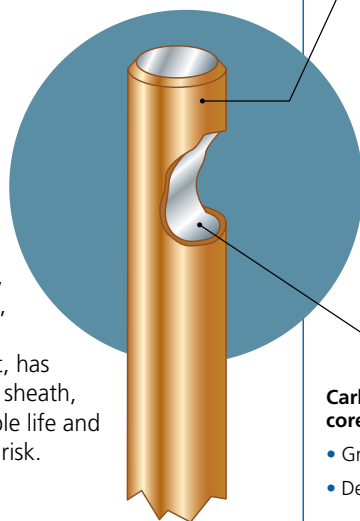

Copper-Bonded Ground Rod	Galvanized Ground Rod
<ul style="list-style-type: none"> <li>• <b>Cost-effective long service life</b></li> </ul>	<ul style="list-style-type: none"> <li>• <b>Lower purchase price — not as cost-effective over the expected life as Copper-bonded</b></li> </ul>
<p><b>Copper-bonded coating:</b></p> <ul style="list-style-type: none"> <li>• Permanent molecular bond</li> <li>• Low resistance performance</li> <li>• High fault current capacity (IEEE® Std 80)                             <ul style="list-style-type: none"> <li>• Will not slip or tear when driven</li> <li>• Will not crack if rod is bent</li> </ul> </li> <li>• Copper coating may vary to meet required standards</li> <li>• 10 mil (254 micron) minimum coating on rods listed to UL® 467</li> </ul>	<p><b>Galvanized coating:</b></p> <ul style="list-style-type: none"> <li>• Relatively short service life</li> <li>• May crack if rod is bent</li> </ul>
<p><b>Carbon Steel core and tip*:</b></p> <ul style="list-style-type: none"> <li>• Greater tensile strength</li> <li>• Deep driving capability</li> </ul>	<p><b>3.9 mil (99 micron) minimum coating per ASTM® 123</b></p>
<p>* ERICO copper-bonded and galvanized rods</p>	

# Ground System Components

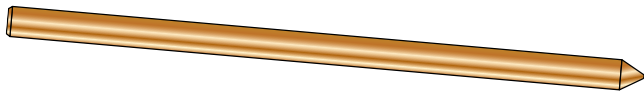

## Copper-Bonded Ground Rod

The copper-bonded ground rod has an electrolytic coating of copper deposited over a layer of nickel. This process ensures a long lasting, molecular bond between the copper layer and the steel core. ERICO recommends copper-bonded ground rods because the copper coating will not slip or tear when driven, nor will it crack if the rod is bent. The tough, carbon steel core has good characteristics for deep driving. Copper-bonded ground rods have a high resistance to corrosion and provide a low resistance path to ground.

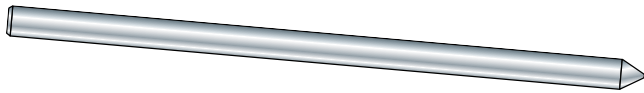

## The Stainless Steel Ground Rod Option

It is important to note that certain soils and land fill areas may not be compatible with copper. In these situations, stainless steel is a better proposition. Stainless steel may also be an alternative, where structures or components, such as steel towers, poles or lead sheathed cables are in close proximity to an array of ground electrodes. In these circumstances, consideration must be given to the consequence of galvanic corrosion. The high cost of stainless steel rods prohibits their widespread use.

## NEGRP

The photo on the left shows two ground rods that were driven into the soil vertically at the Pecos testing site in Las Vegas, NV in December of 1992. The top ground rod is galvanized steel, 3/4" x 10'. Bottom ground rod is copper-bonded, 5/8" x 8'. Both ground rods were exhumed from the site in April of 2004. The loss of zinc resulted in excessive corrosion of the steel. The copper-bonded steel ground rods showed minimal corrosion.



Excavated after 12 years.



Excavated after 11 years.

The photo on the right shows a galvanized steel ground rod driven vertically into the ground at the Pawnee testing site in Las Vegas, NV. One area is reduced from a 3/4" diameter to approximately a 1/4" diameter due to extensive corrosion. The eventual failure would result in a potentially catastrophic loss of ground.

## Ground Rod Life Expectancy

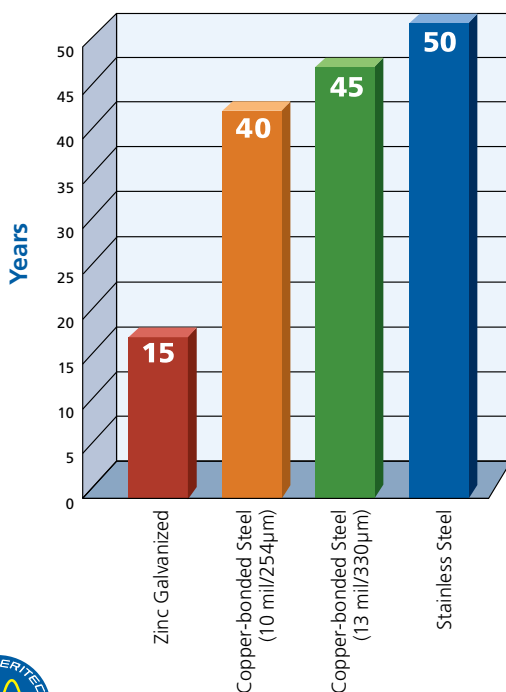

## Ground Rod Annual Cost

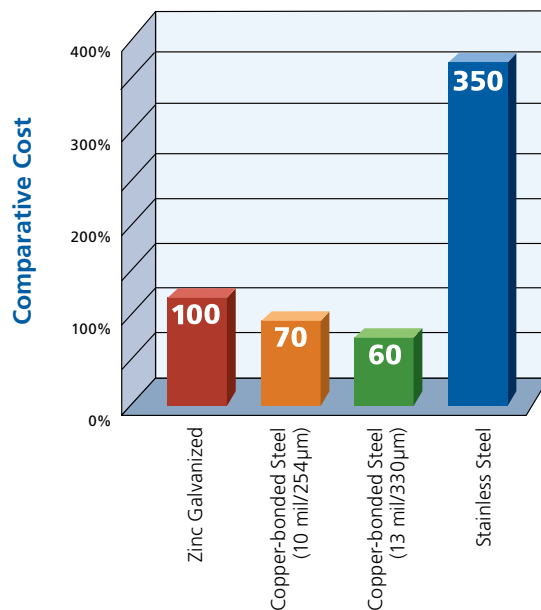

# Grounding System Components



# Ground Conductors

## Conductors

There are two basic criteria for grounding conductor selection:

1. The physical characteristics of the conductor must be of a robust nature, sufficient for the environment.
2. The cross sectional area of the conductor must be of sufficient size, so that it shall successfully conduct the maximum fault current for a period, which allows the operation of protection equipment (or the dissipation of this energy).

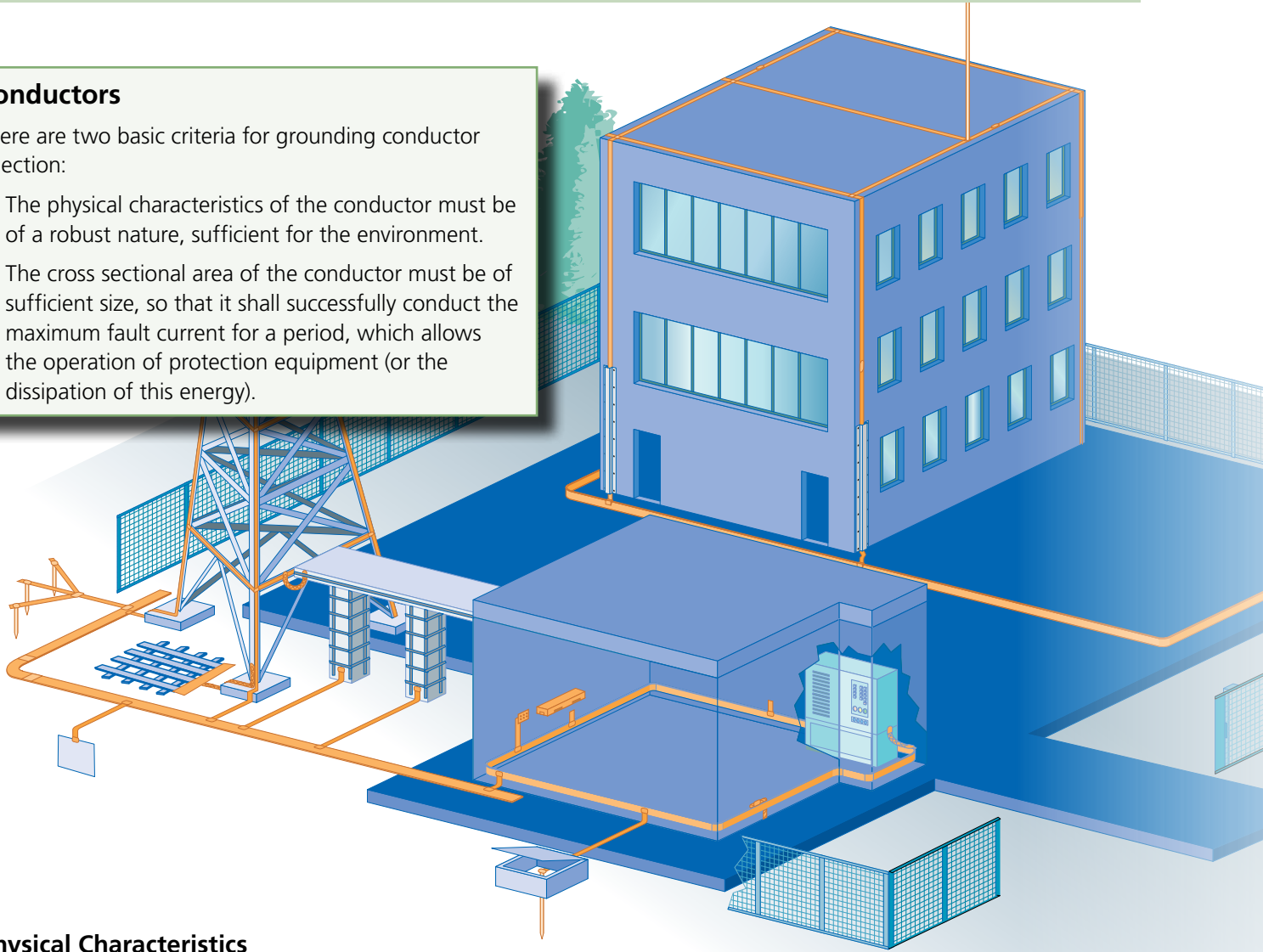

## Physical Characteristics

The most common ground conductor is a soft drawn, stranded copper conductor. Flat copper strip / tape is also popular because it offers a large surface area, resulting in lower impedance.

In some circumstances, the maximum fault current for the installation is small. While a conductor of correspondingly small size could be used, a minimum cross section, often set by the governing authority or applicable standards body (to minimize potential damage likely to occur from any future excavation on the site), is applied.

## Maximum Fault Current

Where higher fault conditions exist, the conductor size is determined by considering the circumstances required to avoid fusing (melting) the conductor. The accepted industry standard is IEEE® 80, Guide for Safety in Substation Grounding.

## Bare Copper & Tinned Copper

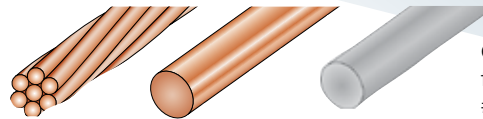

Contact ERICO for available sizes #8 AWG and up.

## Insulated Cables

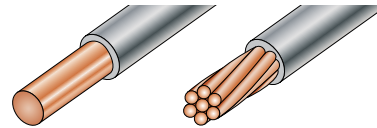

Contact ERICO for available sizes #8 AWG and up.

## Flat Strip Ground Conductor

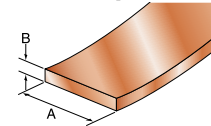

- Pure electrolytic copper
- Low impedance
- Lower impedance than equivalent sized round conductor

Contact ERICO for available sizes minimum thickness of 26 gauge (0.159 in)

## Copper-Bonded Steel Conductor



Contact ERICO for more information.

## Theft Deterrent Composite Cable

Theft deterrent composite cables are bare or insulated concentric stranded conductors that consist of peripheral galvanized steel stranding, which protects and conceals the internal tinned copper strands.

These conductors are ideal for exposed electrical distribution grounding leads where copper theft may occur. These conductors are difficult to cut with hand tools and the outer steel stranding is magnetic, which further deters thieves looking for copper.

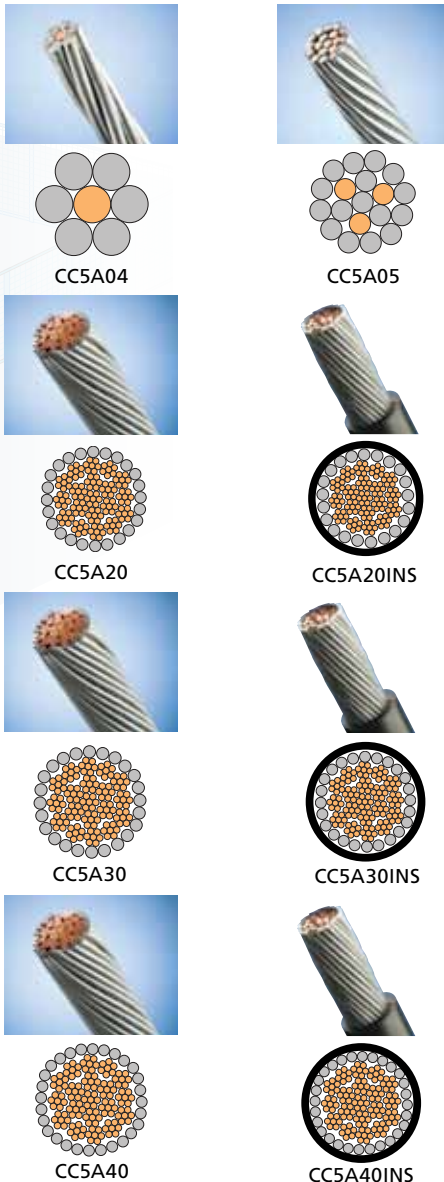

## Aluminum Composite Cable Clip



- For use with CC5A04 Theft Deterrent Cable



Part No.	Conductor Range (AWG)	Standard Package
CCL04A	14 solid – 2/0 solid	100

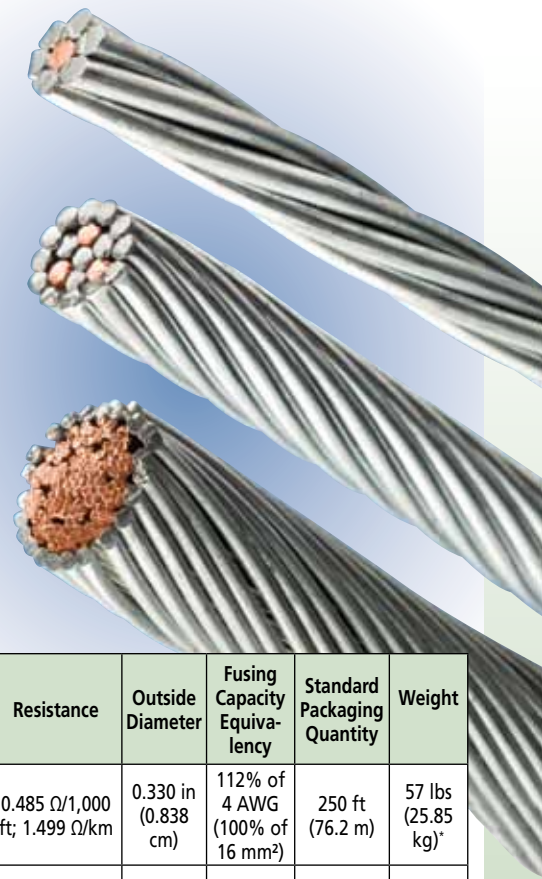

Global Part Number (Reel)	Stranding	Resistance	Outside Diameter	Fusing Capacity Equivalency	Standard Packaging Quantity	Weight
CC5A04	(1) Tinned Copper, (6) Galvanized Steel	0.485 $\Omega$ /1,000 ft; 1.499 $\Omega$ /km	0.330 in (0.838 cm)	112% of 4 AWG (100% of 16 mm <sup>2</sup> )	250 ft (76.2 m)	57 lbs (25.85 kg)*
CC5A05	(3) Tinned Copper, (16) Galvanized Steel	0.457 $\Omega$ /1,000 ft; 1.591 $\Omega$ /km	0.334 in (0.848 cm)	113% of 4 AWG (100% of 16 mm <sup>2</sup> )	250 ft (76.2 m)	58 lbs (26.31 kg)*
CC5A20	(133) Tinned Copper, (21) Galvanized Steel	0.098 $\Omega$ /1,000 ft; 0.320 $\Omega$ /km	0.526 in (1.336 cm)	100% of 2/0 AWG (> 50 mm <sup>2</sup> )	200 ft (61.0 m)	109 lbs (49.44 kg)*
CC5A-20INS	(133) Tinned Copper, (21) Galvanized Steel	0.098 $\Omega$ /1,000 ft; 0.320 $\Omega$ /km	0.526 in (1.336 cm)	100% of 2/0 AWG (> 50 mm <sup>2</sup> )	200 ft (61.0 m)	135 lbs (61.24 kg)*
CC5A30	(133) Tinned Copper, (24) Galvanized Steel	0.076 $\Omega$ /1,000 ft; 0.249 $\Omega$ /km	0.572 in (1.453 cm)	100% of 3/0 AWG (> 70 mm <sup>2</sup> )	200 ft (61.0 m)	135 lbs (61.23 kg)*
CC5A-30INS	(133) Tinned Copper, (24) Galvanized Steel	0.076 $\Omega$ /1,000 ft; 0.249 $\Omega$ /km	0.572 in (1.453 cm)	100% of 3/0 AWG (> 70 mm <sup>2</sup> )	200 ft (61.0 m)	135 lbs (61.23 kg)*
CC5A-30INSK	(133) Tinned Copper, (24) Galvanized Steel	0.076 $\Omega$ /1,000 ft; 0.249 $\Omega$ /km	0.572 in (1.453 cm)	100% of 3/0 AWG (> 70 mm <sup>2</sup> )	1000 ft (304.8 m)	677.2 lbs (367.2 kg)*
CC5A40	(133) Tinned Copper, (28) Galvanized Steel	0.057 $\Omega$ /1,000 ft; 0.188 $\Omega$ /km	0.656 in (1.666 cm)	100% of 4/0 AWG (> 95 mm <sup>2</sup> )	200 ft (61.0 m)	172 lbs (78.02 kg)*
CC5A-40INS	(133) Tinned Copper, (28) Galvanized Steel	0.057 $\Omega$ /1,000 ft; 0.188 $\Omega$ /km	0.656 in (1.666 cm)	100% of 4/0 AWG (> 95 mm <sup>2</sup> )	200 ft (61.0 m)	199 lbs (90.27 kg)*

\*Weight does not include reel.

# Ground Rods and Couplers



## Ground Rods

### Ground Rod Diameter and Length

Ground rod diameter must also be considered. Although larger diameter rods are more rigid and less prone to whip or bending, they may have a greater drag than smaller diameter rods when being driven. It must also be noted that increasing the ground rod diameter has relatively small impact on grounding system resistance when compared to length. Standards nominate a minimum diameter or periphery and thickness if not cylindrical, mainly based on mechanical strength.

In general, lightning protection standards recommend copper-bonded electrodes of specified diameter. Standard UL 467 requires a minimum rod length of 8' with a minimum diameter of 0.50" and 10 mils of copper.

Other standards may nominate a specific resistance for the installation. If space is limited, the contractor may be required to install electrodes to a depth that achieves the required value.

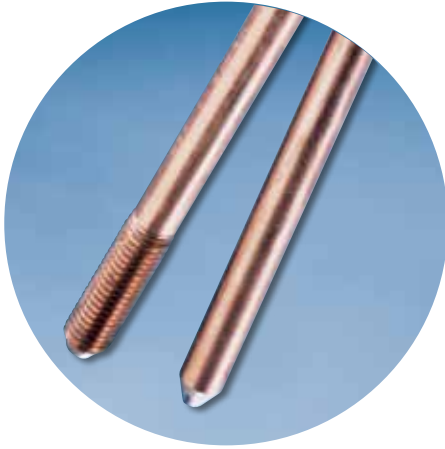

## Ground Electrodes

### Ground Rod Accessories and Application

ERICO, a leading manufacturer of UL® listed copper-bonded ground rods, offers a complete range of rods, driving sleeves and studs, rod coupling methods and connections for reliable grounding in nearly any application.

### Driving Sleeves

The driving sleeve fits over the pointed ground rod to protect the rod end from "mushrooming" as the ground rod is driven into earth.



### Compression Coupling

Couplings enable ground rods to be driven quickly and easily without the risk of rod separation. They are generally tapered so when the rod is driven into the coupling, the two parts compress to form a conductive connection.

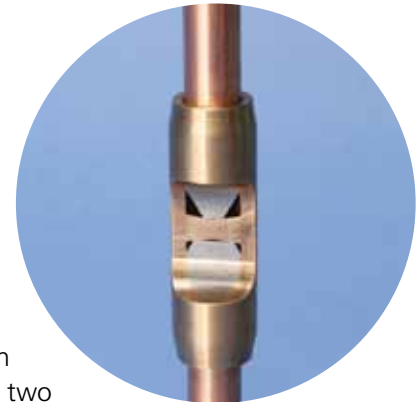

### Threaded Coupling

Threaded couplings allow for full contact of the rod point with the butt end of the preceding rod.

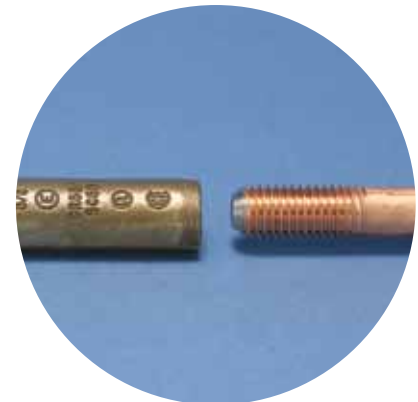



## Copper-Bonded Ground Rods Pointed Rods

- 99.9% pure electrolytic copper coating
- Molecular bond to nickel-sealed high strength steel core
- Tensile strength greater than 80,000 PSI on 1/2" & 90,000 PSI on 5/8" and 3/4"
- Minimum copper coating of 10 mils on rods listed to UL® 467
- Legibly marked with manufacturer's ID and catalog designation
- Manufactured to exceed the requirements of ANSI®/NEMA® GR1

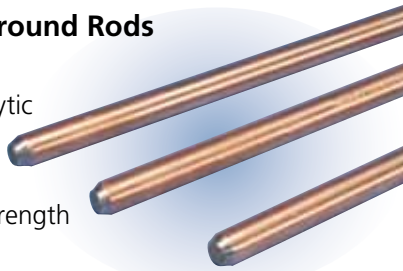

Part No.	Nominal Diameter (in)	Length (ft)	Plating Thickness (mils)	Weight per 100 rods (lbs)	Standard Bundle
613840**	3/8	4	10	135	5
613880**	3/8	8	10	270	5
611380	1/2	8	10	553	5
615880	5/8	8	10	680	5
615883	5/8	8	13*	680	5
613480	3/4	8	10	1,000	5
613483	3/4	8	13*	1,000	5
611300	1/2	10	10	738	5
615800	5/8	10	10	844	5
615803	5/8	10	13*	844	5
613400	3/4	10	10	1,240	5
614400	1	10	10	2,204	5
615812	5/8	12	10	1,000	5
613412	3/4	12	10	1,480	5
615815	5/8	15	10	1,275	5
613415	3/4	15	10	1,850	5

\* 13 mils of copper meet specifications of RUS.

\*\* Non-UL listed rods.

† Additional lengths available.

## Threadless Compression Couplers for Copper-Bonded Pointed Rods



- Made of high-strength silicon bronze
- Tapered so when rod is driven into coupling, parts compress to form a conductive connection
- UL & CSA® Listed



Part No.	Nominal Rod Diameter (in)	Unit Weight (lbs)	Unit Weight (kg)	Standard Package
CC12F	1/2 (full)	0.240	0.108	25
CC58	5/8	0.300	0.134	25
CC34	3/4	0.450	0.202	25

## Steel Driving Sleeves for Pointed Rods\*



- Slides on top of ground rod to prevent mushrooming while driving into ground

Part No.	Ground Rod Size (Unthreaded)	Standard Package
B13714	1/2" Copper-Bonded or Steel rod	1
B13716	5/8" Copper-Bonded rod (.563" diameter)	1
B13731	5/8" Steel rod (.625" diameter)	1
B13718	3/4" Copper-Bonded rod (.682" diameter)	1
B13733	3/4" Steel rod (.750" diameter)	1
B13722	1" Copper-Bonded rod (.914" diameter)	1
B13737	1" Steel rod (1.00" diameter)	1

\*For unthreaded ground rods only.

## Economical Sleeves for 5/8" Copper-Bonded, Pointed Rods



Part No.	Ground Rod Size	Standard Package
EDS58	5/8" Copper-Bonded Rods (.563" diameter)	1

## Driving Heads For Copper-Bonded Pointed Rods



- For use in power assisted ground rod drivers

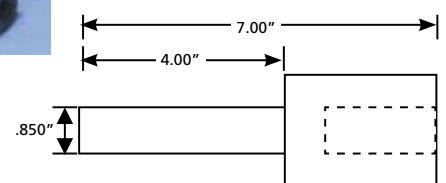

Part No.	Ground Rod Size	Standard Package
DH58	5/8" Copper-Bonded Rods (.563" diameter)	1
DH34	3/4" Copper-Bonded Rods (.682" diameter)	1

# Ground Rods and Couplers



## Ground Rod Driver

- Usable on all types of round ground rods: copper-bonded, galvanized, stainless steel
- 5/8" (14.2 mm) and 3/4" (17.2 mm) inserts are interchangeable with standard driver body
- The driver will not deform the end of the rod, making connection of the ground conductor quick and easy

Part No.	Description	Weight (lbs)
EGRD58	5' Driver body with insert for up to 5/8" ground rods	23
EGRD58 I *	Replacement insert for 5/8" copper-bonded ground rods	6
EGRD34	5' Driver body with insert for up to 3/4" ground rods	23
EGRD34 I *	Replacement insert for 3/4" copper-bonded ground rods and 5/8" galvanized ground rods	6

\*Both 5/8" and 3/4" inserts fit standard driver body.

## Driving Stud For Threaded Rods



Part No.	Nominal Rod Diameter (in)	Standard Package
DS125	1/2 (full)	25
DS58	5/8	25
DS34	3/4	25
DS1	1	1

## Couplers For Threaded Rods



- High-strength couplings are threaded bronze and chamfered at both ends for easy driving
- Corrosion-resistant couplings ensure permanent, low-resistance copper-to-copper connections
- UL® & CSA® Listed

Part No.	Nominal Rod Diameter (in)	Standard Package
CR125	1/2 (full)	25
CR58	5/8	25
CR34	3/4	25
CR100	1	1

## Copper-Bonded Ground Rods Sectional, Threaded Rods



- Cold-rolled threads with continuous, unbroken grain flows preserve copper coating and are stronger than cut threads
- Electrolytically copper-bonded steel: copper is molecularly bonded to nickel-sealed, high-strength steel cores
- Minimum copper coating of 10 mils on rods listed to UL® 467
- ERITECH® name, length, diameter and part number is roll-stamped within 12" of chamfered end
- UL logo and control number where applicable stamped on each rod for easy inspection after installation
- Manufactured to exceed the requirements of ANSI/NEMA® GR1

Part No.	Nominal Diameter (in)	Length (ft)	Plating Thickness (mils)	Weight per 100 rods (lbs)	Standard Bundle
631300	1/2	10	10	688	5
631380	1/2	8	10	540	5
633400	3/4	10	10	1,240	5
633480	3/4	8	10	1,000	5
634400	1	10	10	2,204	5
635800	5/8	10	10	844	5
635830	5/8	3	10	262	5
635840	5/8	4	10	344	5
635850	5/8	5	10	420	5
635860	5/8	6	10	504	5
635880	5/8	8	10	680	5
635883	5/8	8	13*	680	5

\* 13 mils of copper meet specifications of RUS



# Ground Rods and Couplers

## Stainless Steel Ground Rods



- Sectional rods utilize a cut thread for highly corrosive soil

Part No.	Nominal Diameter (in)	Length (ft)	Stainless Steel Type	Rod Type	Standard Bundle
681300	1/2 (full)	10	302 - 304	Pointed	5
683400	3/4 (full)	10	302 - 304	Pointed	5
683450	3/4 (full)	5	302 - 304	Pointed	5
683480	3/4 (full)	8	302 - 304	Pointed	5
685800	5/8 (full)	10	302 - 304	Pointed	5
685880	5/8 (full)	8	302 - 304	Pointed	5
681300S	1/2 (full)	10	302 - 304	Sectional	5
683400S	3/4 (full)	10	302 - 304	Sectional	5
683450S	3/4 (full)	5	302 - 304	Sectional	5
685800S	5/8 (full)	10	302 - 304	Sectional	5
685880S	5/8 (full)	8	302 - 304	Sectional	5

## Couplers for Threaded Stainless Steel Ground Rods



Part No.	Nominal Rod Diameter (in)	Stainless Steel Type	Standard Package
CR58SS	5/8 (full)	304	1
CR34SS	3/4 (full)	304	1

## Compression Couplers for Threadless Stainless Steel Ground Rods



Part No.	Nominal Rod Diameter (in)	Stainless Steel Type	Standard Package
CC58SS	5/8 (full)	304	1
CC34SS	3/4 (full)	304	1

## Galvanized Steel Compression Coupler



Part No.	Rod Diameter (in)	Standard Package
GCC58F	5/8 (full)	25
GCC34	3/4 (.727-.738)	25



## Galvanized Pointed Ground Rods



- Meets ANSI®/NEMA® GR1
- RUS Approved where indicated
- Zinc-coated exteriors are hot-dip galvanized for solid protection against corrosion, in accordance with ASTM® specification A153-78
- Surfaces are rigidly inspected to eliminate seams, slivers and other defects

Part No.	Nominal Diameter (in)	Length (ft)	Weight per 100 rods (lbs)	Standard Bundle
811350	1/2 (full)	5	344	5
811360	1/2 (full)	6	413	5
811380	1/2 (full)	8	550	5
813400*	3/4	10	1,396	5
813460*	3/4	6	858	5
813480*	3/4	8	1,120	5
814400	1	10	2,716	5
815800*	5/8 (full)	10	1,060	5
815850	5/8 (full)	5	530	5
815860*	5/8 (full)	6	636	5
815880*	5/8 (full)	8	844	5

\* For rods with a UPC label, add "UPC" to end of part number (example: 813400UPC).

- Meets specifications of RUS.

## Convenient Ground Electrode (CGE) Kits

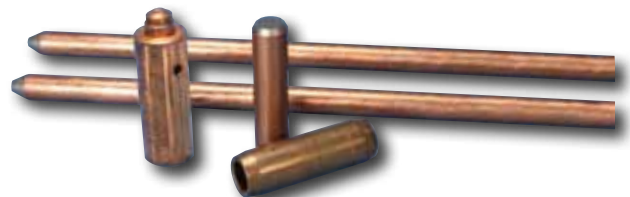

- The UL®-Listed, NEC®-Compliant ERITECH CGE kit allows for installation from ground level and is much easier to transport than eight-foot ground rods.

- The ERITECH CGE kits are designed for #6 and #4 solid copper conductor applications.

Article No.	Part No.	KIT INCLUDES			Wire Sizes	Metric Wire Sizes
		2 - ERITECH Ground Rods	ERITECH HAMMERLOCK or Clamp	ERITECH Drive Sleeve		
155991	CGE51K	615840	EHL58C1K	EDS58	#4 Sol - #6 Sol	10mm² Str - 16mm² Str
155993	CGE5CP	615840	CP58	EDS58	#8 Sol - #2 Str	10mm² Sol - 35mm² Str

# Ground Clamps and Connectors

## ERITECH® HAMMERLOCK

- Low resistance connection
- Irreversible connection with excellent mechanical strength
- Fast and simple installation
- cULus Listed



### ERITECH® HAMMERLOCK for 2 Conductors



Part No.	Ground Rod Size (in)	Conductor Range (AWG)
<b>For Copper-bonded Ground Rods</b>		
EHL12FC2G	1/2 (full)	1/0 stranded – 2/0 stranded
EHL12FC1V	1/2 (full)	4 stranded – 2 stranded
EHL12FC1K	1/2 (full)	6 solid – 4 solid
EHL58C2G	5/8	1/0 stranded – 2/0 stranded
EHL58C1V	5/8	4 stranded – 2 stranded
EHL58C1K	5/8	6 solid – 4 solid
EHL34C2G	3/4	1/0 stranded – 2/0 stranded
EHL34C1V	3/4	4 stranded – 2 stranded
EHL34C1K	3/4	6 solid – 4 solid

Standard Package: 25

Part No.	Ground Rod Size (in)	Conductor Range (AWG)
<b>For Galvanized Ground Rods</b>		
EHL58G2G	5/8 (full)	1/0 stranded – 2/0 stranded
EHL58G1V	5/8 (full)	4 stranded – 2 stranded
EHL58G1K	5/8 (full)	6 solid – 4 solid
EHL34G1V	3/4	4 stranded – 2 stranded
EHL34G1V*	3/4	4 stranded – 2 stranded
EHL34G1K	3/4	6 solid – 4 solid
EHL34G1K*	3/4	6 solid – 4 solid

Standard Package: 25

Part No.	Ground Rod Size (in)	Conductor Range (AWG)
<b>For Copper-bonded Ground Rods</b>		
EHL12FC1K1K*	1/2 in	6 solid – 4 solid
EHL58C1K1K*	5/8 in	6 solid – 4 solid
<b>For Galvanized Ground Rods</b>		
EHL58G1K1K*	5/8 in	6 solid – 4 solid

\*Not UL® Listed

### Bronze Ground Rod Clamps

- High-strength silicon bronze
- For use with copper-bonded ground rods
- Suitable for direct burial
- UL Listed for direct burial in earth or concrete
- CSA Listed



Part No.	Rod Diameter (in)	Conductor Range (AWG)	Standard Package
<b>Standard Duty</b>			
CP38†	3/8	10 solid – 2 stranded	100
CP58	1/2 - 5/8	10 solid – 2 stranded	50
CP34	1/2 - 3/4	10 solid – 1/0 stranded	50
<b>Heavy Duty</b>			
HDC12	1/2	10 solid – 2 stranded	50
HDC58 <sup>a</sup>	5/8	8 solid – 1/0 stranded	50
HDC58R <sup>a</sup>	5/8	8 solid – 1/0 stranded	50
HDC34	3/4	8 solid – 1/0 stranded	25
HDC34SP*	3/4	8 solid – 3/0 stranded	25
HDC1 <sup>†</sup>	1	8 solid – 4/0 stranded	1

<sup>a</sup> HDC58 threads are 1/2" – 13 UNC. HDC58R threads are 7/16" – 14 UNC.

\* Not UL Listed

† Not CSA Listed



## SP58 Stainless Steel Ground Clamp



- Unique stamped body design will not crack with excessive torque values
- Provides a greater surface area contact to allow improved performance of the connector
- Compatible with copper, copper-bonded, galvanized, stainless steel, rebar and plain steel ground rods and electrodes

- cULus® Listed; RUS Approved

Part No.	Rod Diameter (in)	Conductor Range (AWG)	Minimum Torque	Rebar Size	Standard Package
SP58*	1/2, 5/8	10 solid – 2 stranded	300 in – lbs	#4	50
SP58 B916 <sup>Δ</sup>	1/2, 5/8	10 solid – 2 stranded	300 in – lbs	#4	50

\* With 9/16" bolt head

<sup>Δ</sup> UL Listed for direct burial in earth or concrete.

## Tinned Bronze Ground Clamps



- Made of high copper-content alloy
- Theft-deterrent appearance
- Stainless steel nuts, bolts and washer included
- For use on 5/8" - 3/4" rods

Part No.	Conductor Range (AWG)	Standard Package
GC064	4 Solid - 2/0 Stranded	50
GC065	2/0 Solid - 250 MCM Stranded	50
GC065TH	2/0 Solid - 250 MCM Stranded	5

## Split Bolts



Silicon Bronze



Tin-Plated Silicon Bronze

- High strength
- Silicon bronze for copper to copper connections.
- Tin plated, high strength copper alloy split bolt with spacer separates dissimilar conductors which allow you to connect: copper to copper; copper to aluminum; aluminum to aluminum. (Oxide inhibitor recommended when used on aluminum conductor.)
- UL® Listed

Part No.	Conductor Range (AWG)	Standard Package
<b>Silicon Bronze</b>		
ESB8	16 stranded – 8 stranded	100
ESB6	10 solid – 6 stranded	100
ESB4	8 solid – 4 solid	100
ESB2	6 solid – 2 stranded	50
ESB1/0*	4 solid – 1/0 stranded	50
ESB2/0*	2 solid – 2/0 stranded	25
ESB4/0*	1/0 solid – 250 MCM	25
<b>Tin-Plated Silicon Bronze</b>		
ESBP8*	14 stranded – 8 stranded	100
ESBP6*	10 stranded – 6 stranded	100
ESBP4*	8 solid – 3 stranded	100
ESBP2*	8 solid – 2 stranded	100
ESBP1/0*	6 solid – 1/0 stranded	50
ESBP2/0*	8 solid – 2/0 stranded	25
ESBP4/0*	4 stranded – 250 MCM	25
ESBP350*	3/0 stranded – 350 MCM	25

\* Not UL Listed

## Direct Burial Ground Clamps



EK16:  
Parallel connection



EK17:  
Perpendicular connection

- Universal use for rebar, rods or pipes
- Lay-in feature cuts installation time
- Bronze alloy construction with bronze screws
- Approved for direct burial in earth and concrete
- cULus Listed

Part No.	Conductor Range (AWG)	Conductor Range (metric)	Rebar Size (imperial)	Rebar Size (metric)	Standard Package
EK16	10 solid - 2 solid	5.5 mm <sup>2</sup> – 25 mm <sup>2</sup>	#4 – #8	10 – 25 mm	50
EK17	10 solid - 2 solid	5.5 mm <sup>2</sup> – 25 mm <sup>2</sup>	#4 – #8	10 – 25 mm	50

# Ground Clamps and Connectors

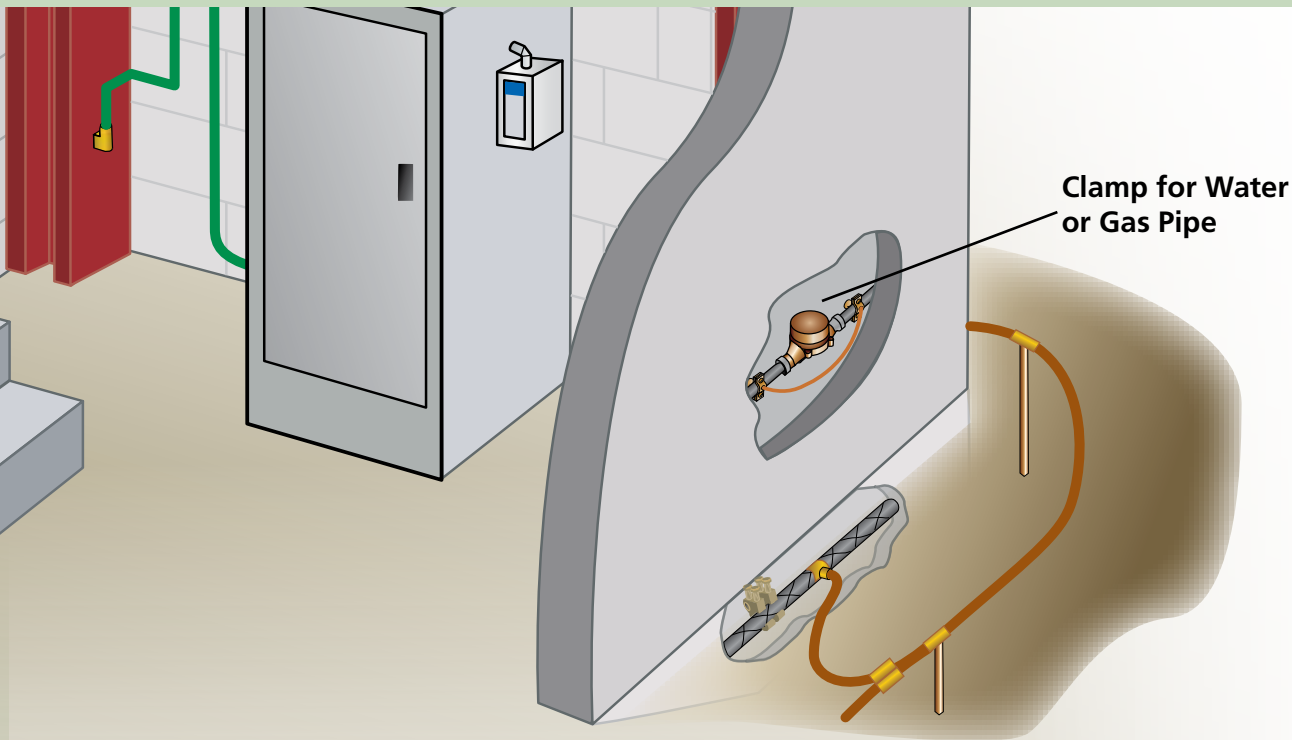

## Bronze Clamps for Water or Gas Pipe (including brass hex fittings)



- High-strength silicone bronze
- Used for connecting copper conductors to metallic water pipe, ground rods, or flexible gas pipe (CSST) with brass hex fittings
- Conform to the requirements of the 2009 edition of NFPA® 54, NFGC® (National Fuel Gas Code) and NEC® (National Electric Code) for bonding corrugated stainless steel tubing (CSST) gas piping systems to the grounding conductor of the building's electrical system
- SH version for outdoor applications
- cULus Listed

Part No.	Water Pipe Size (in)	Conductor Range (AWG)	Hex Nut Size (in)	Standard Package
CWP1J	.5 – 1	10 solid – 2 solid	1 – 1.25	25
CWP2J	1.25 – 2	10 solid – 2 stranded	1.5 – 2.125	12
CWP3J	2.5 – 4	10 solid – 4 stranded	2.5 – 3.125	4
CWP1JSH	.5 – 1	10 solid – 2 solid	1 – 1.25	25
CWP2JSH	1.25 – 2	10 solid – 2 stranded	1.5 – 2.125	12
CWP3JSH	2.5 – 4	10 solid – 4 stranded	2.5 – 3.125	4

## Bronze Clamps for Water Pipe



CWP1JU

CWP2JU\*

- High-strength silicone bronze
- Used for connecting copper conductors to metallic water pipe or ground rods
- CSA® Listed

Part No.	Water Pipe Size (in)	Conductor Range (AWG)	Standard Package
CWP1JU†	.5 – 1	10 solid – 4 stranded	100
CWP1JU*	.5 – 1	10 solid – 2 stranded	1
CWP2JU*	1.25 – 2	10 solid – 2 stranded	1
CWP6J	4.25 – 6	10 solid – 4 stranded	1
CWP4J**	2.5 – 4	10 solid – 4 stranded	1

\* With copper screw for use in direct burial applications

\*\* UL® Listed

† Not CSA Listed

## Zinc Clamp for Water Pipe



- Zinc die cast
- cULus Listed

Part No.	Water Pipe Size (in)	Conductor Range (AWG)	Standard Package
ZWP1J	.5 – 1	10 solid – 6 solid	25



# Ground Clamps and Connectors

## Bronze Pipe Clamp to Rigid Conduit



- For use in grounding rigid conduit systems to metallic water pipe

Part No.	Water Pipe Size (in)	Conductor Range (AWG)	Conduit Size (in)	Standard Package
CWP1JH12	.5 - 1	10 solid - 6 solid	.5	100
CWP1JH34	.5 - 1	10 solid - 2/0 stranded	.75	100
CWP2JH34	1.25 - 2	10 solid - 2/0 stranded	.75	100
CWP4JH34	2.5 - 4	10 solid - 2/0 stranded	.75	50
CWP2JH44	1.25 - 2	10 solid - 3/0 stranded	1	100

## Bronze Pipe Clamp to Rigid Conduit



- For use in grounding rigid conduit systems to metallic water pipe

Part No.	Water Pipe Size (in)	Conductor Range (AWG)	Conduit Size (in)	Standard Package
CWP12SHE	.5 - 1	10 solid - 6 solid	.5	100
CWP34SHE	.5 - 1	10 solid - 2/0 stranded	.75	100

## Tinned Bronze Fence Clamps



- Made from high copper-content alloy
- Theft-deterrent appearance
- Stainless steel nuts, bolts and washers included

Part No.	Pipe Size (in)	Conductor Size (AWG)	Conductor Size (mm <sup>2</sup> )	Pipe Size (mm)
<b>Single Hole</b>				
FC073	1-1/2	4 Solid - 2/0 Stranded	16 - 70 Stranded	40
FC074	1-1/2	2/0 Solid - 250 MCM Stranded	50 - 120 Stranded	40
FC075	2	4 Solid - 2/0 Stranded	16 - 70 Stranded	50
FC076	2	2/0 Solid - 250 MCM Stranded	50 - 120 Stranded	50
FC078	2-1/2	2/0 Solid - 250 MCM Stranded	16 - 120 Stranded	65
FC079	3	4 Solid - 2/0 Stranded	16 - 70 Stranded	80
FC080	3	2/0 Solid - 250 MCM Stranded	50 - 120 Stranded	80
FC082	3-1/2	4 Solid - 2/0 Stranded	16 - 120 Stranded	90
<b>Dual Hole</b>				
FC076 DH	2	2 x 2/0 Solid - 250 MCM Stranded	50 - 120 Stranded	50
FC078 DH	2-1/2	2 x 2/0 Solid - 250 MCM Stranded	16 - 120 Stranded	65
FC082 DH	3-1/2	2 x 4 Solid - 2/0 Stranded	16 - 120 Stranded	90

## Bronze Vise Clamps



VC62

VC220

- Used to splice 2 conductors together

Part No.	Conductor Range (AWG)	Standard Package
VC62	6 solid - 2 solid	25
VC220	2 solid - 2/0 stranded	25

# Ground Clamps and Connectors



## Transformer Tank Grounding Connectors



TGC2/0



CC207



CC207SI



CC207SIJ

- Cast of high conductivity bronze and 1/2" – 13 stud
- Fit all EEI-NEMA distribution transformers
- No special tools required — use regular lineman's wrench
- RUS Approved

Part No.	Conductor Range (AWG)	Stud Thread Size	Standard Package
TGC2/0*	10 solid – 2/0 stranded	1/2" – 13	100
CC207	6 solid – 1/0 stranded	1/2" – 13	50
CC207SI	6 solid – 1/0 stranded	1/2" – 13; 1" long	50
CC207SIJ	6 solid – 1/0 stranded	1/2" – 13; with jam nut	50
CC2074/0	2/0 stranded – 4/0 stranded	1/2" – 13	25

\* Eye bolt rotates to accommodate cable in either vertical or horizontal direction

## Tin-Plated, Silicon Bronze Jumper Clamp



- For use in telecom applications
- UL® Listed

Part No.	Conductor Range (AWG)	Standard Package
KUL	6 solid	100

## Copper Lug Mechanical Connector



Part No.	Conductor Range (AWG)	Stud Thread Size	Standard Package
EL4	14 solid – 4 stranded	5/16-24 UNF-2B	100

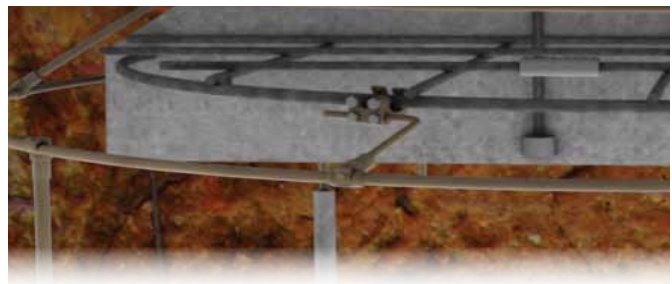

## Heavy Duty Rebar Clamps



- Provides two connection points to concrete encased electrodes (rebar) for states where the Authority Having Jurisdiction (AHJ) requires it.
- Meets 2005 NEC® standard requirement for bonding to rebar into the grounding system
- Has high-strength bronze alloy construction
- Easy to install
- UL Listed

Part No.	Conductor Range (AWG)	Conductor Range (metric)	Rebar Size (imperial)	Rebar Size (metric)	Standard Package
RC70	8 solid – 2/0 stranded	10 – 70 mm <sup>2</sup>	#3 – #6	8 – 18 mm	1
RC100	8 solid – 4/0 stranded	10 – 100 mm <sup>2</sup>	#6 – #11	18 – 36 mm	1





# Ground Clamps and Connectors



## Intersystem Bonding Termination Bar (IBTB)



- Interconnects and terminates grounding conductors from electrical power service, telephone, CATV, radio and TV antennas
- Ideal for residential and small commercial applications
- Meets requirements of 2008 NEC Article 250.94
- cULus® Listed

Part No.	Conductor Range	Standard Package
IBTB	(5) 14 Solid - 6 Stranded; (1) 6 Solid - 2 Stranded; (5) 1.5 - 25mm <sup>2</sup> ; (1) 16 - 35 mm <sup>2</sup>	10

## Lay-In Lug



- Tinned Copper
- Lay-in feature allows for easy positioning
- cULus Listed

Part No.	Conductor Range	Standard Package
EL6CEDB	#14 Solid - #4 Solid	50

## Solar Bonding Lug



- Bonds the frames and mounting structures of solar photo voltaic systems in accordance with NEC® requirements
- Copper alloy is corrosion resistant and galvanically compatible with copper grounding conductors and aluminum photo voltaic module frames
- Lay-in feature allows for easy positioning along multiple frames
- cULus Listed

Part No.	Description	Conductor Range (AWG)
EL6CS	Tinned Bronze Lug with #10 Hardware	#14 Sol - #6 Str
EL6CS8	Tinned Bronze Lug with #8 Hardware	#14 Sol - #6 Str
EL6CSNH	Tinned Bronze Lug without Hardware	#14 Sol - #6 Str
EL6CSDB	Direct Burial - Tinned Bronze Lug with #10 Hardware	#14 Sol - #6 Str
EL6CSDB8	Direct Burial - Tinned Bronze Lug with #8 Hardware	#14 Sol - #6 Str
EL6CSDBNH	Direct Burial - Tinned Bronze Lug without Hardware	#14 Sol - #6 Str

## Potential Equalization Clamp - PEC100



- High peak current capability - long service life
- Weatherproof enclosure - suitable for direct burial
- ATEX approved

The PEC is an equipotential bonding device that can be used to minimize damage in applications where separated ground systems are required. The PEC is ATEX approved, making the device suitable for use in explosion hazard areas such as the protection of pipeline insulated joints.

# Chemical Ground Electrodes

Chemical ground electrodes, part of the ERITECH® line of Facility Electrical Protection products from ERICO, provide a low impedance ground in locations of high soil resistivity and dry soil conditions. Used in conjunction with a bentonite backfill and ERICO's unique GEM material, the ERITECH brand of chemical ground electrode system provides a method to improve soil resistivity directly surrounding the electrode, and can replace multiple conventional ground rods. It maintains a low ground resistance, maintenance-free installation that dissipates lightning energy and other dangerous electrical fault currents, even in sandy or rocky soil conditions. The chemical ground electrode is useful for providing an effective earth in poor soil conditions where space for electrodes is limited. Market applications include telecommunications, power generation and distribution, commercial and industrial, manufacturing, transportation (rail and aviation), lightning protection, recreational facilities, and defense.

ERITECH brand of chemical ground electrodes are most effective when installed as part of a total system that includes high conductivity backfill materials, access/inspection wells, and permanent, reliable CADWELD® connections. They may be installed either vertically or horizontally.

## Features

- Contain natural electrolytic salts, which permeate into the surrounding soil to condition the soil and increase its conductivity
- Low impedance to effectively dissipate lightning and electrical fault currents
- Easy connection to ground electrode conductor using the factory provided pigtail (up or down orientation)
- Provides decades of reliable services due to rugged construction, and high quality metals with a 30-year minimum service life
- 2-1/8" outside diameter, Type K copper pipe, 0.083" wall contains natural electrolytic salts that permeate into the surrounding soil, improving electrode to soil connection
- Available in continuous sections up to 10 feet in length; longer rods can be field assembled using 5- or 10-foot extensions
- Optional factory attached radial strips are available to reduce impedance to high-frequency lightning energy and to control the direction of the dissipation
- L-shaped rods are available for horizontal installation applications where it is impractical to auger deep vertical holes
- Access segment on horizontal (L-shaped) chemical ground electrodes is 32" deep
- Over 100 configurations available

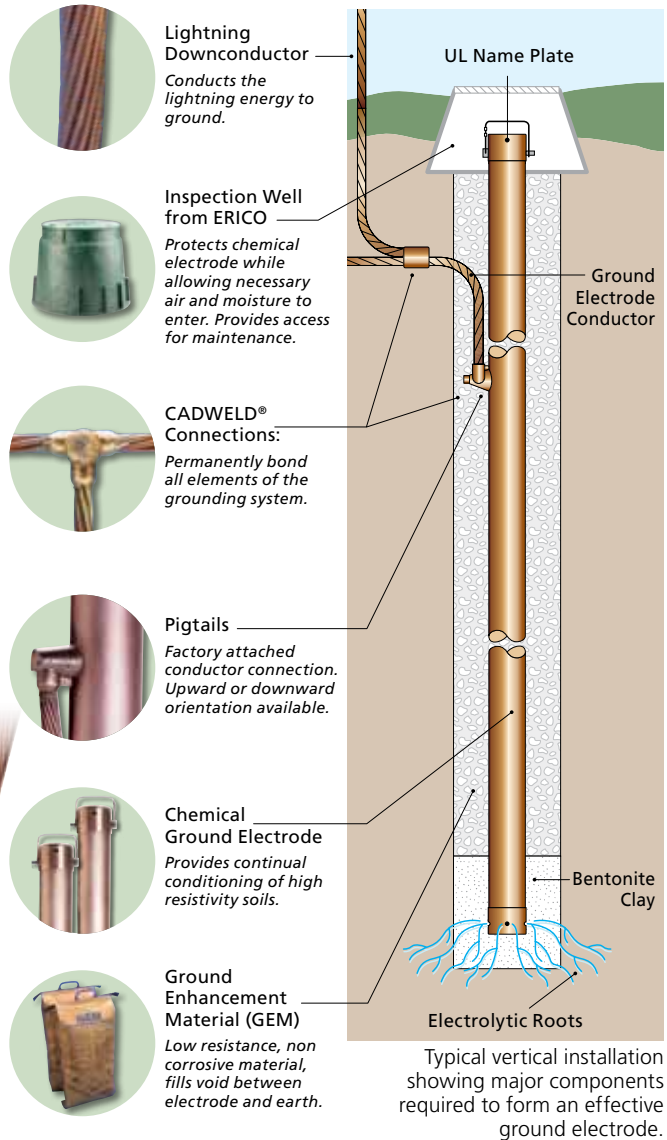

## Reference Part Number Code

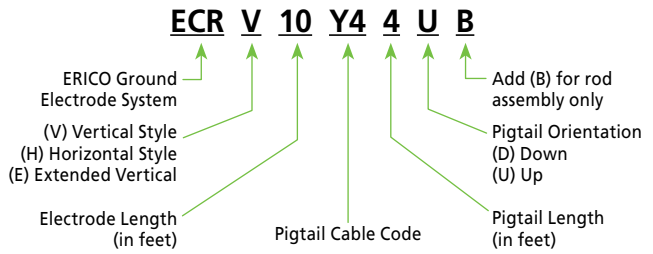

Chemical ground rods can be ordered as individual components or as a complete kit. Kits include the chemical electrode (pre-filled with electrolytic salts), Bentonite, GEM backfill, and an access well. To order the chemical electrode only, add "B" to the end of the part number.



# Chemical Ground Electrodes

Part No.	Height (in)	Length (ft)	Conductor Size (AWG)	Cable Code	Pigtail Length (ft)
<b>Horizontal Installation</b>					
ECRH081T4D	32	8	#2 Solid, Tinned	1T	4
ECRH081T4U	32	8	#2 Solid, Tinned	1T	4
ECRH081T4UB*	32	8	#2 Solid, Tinned	1T	4
ECRH082C4U	32	8	1/0 Stranded	2C	4
ECRH101T4D	32	10	#2 Solid, Tinned	1T	4
ECRH102C4U	32	10	1/0 Stranded	2C	4
ECRH102Q4D	32	10	4/0 Stranded	2Q	4
ECRH102Q4DB*	32	10	4/0 Stranded	2Q	4
ECRH102G4U	32	10	2/0 Stranded	2G	4
ECRH102G4D	32	10	2/0 Stranded	2G	4
ECRH102Q4U	32	10	4/0 Stranded	2Q	4
ECRH101T4U	32	10	#2 Solid, Tinned	1T	4
ECRHE152Q4D	32	15	4/0 Stranded	2Q	4
ECRHE202Q4U	32	20	4/0 Stranded	2Q	4
<b>Vertical Installation</b>					
ECRV102L4U	10	-	3/0 Stranded	2L	4
ECRV102Q3U	10	-	4/0 Stranded	2Q	3
ECRV102C4U	10	-	1/0 Stranded	2C	4
ECRV102Q10U	10	-	4/0 Stranded	2Q	10
ECRV102V4D	10	-	250 MCM Stranded	2V	4
ECRV101T4D	10	-	#2 Solid, Tinned	1T	4
ECRV101V10D	10	-	#2 Stranded	1V	10
ECRV102Q5U	10	-	4/0 Stranded	2Q	5
ECRV102Q4UB*	10	-	4/0 Stranded	2Q	4
ECRV102Q5UB*	10	-	4/0 Stranded	2Q	5
ECRV103Q4D	10	-	500 MCM Stranded	3Q	4
ECRV102G4U	10	-	2/0 Stranded	2G	4
ECRV101T4U	10	-	#2 Solid, Tinned	1T	4
ECRV102G4D	10	-	2/0 Stranded	2G	4
ECRV102Q4D	10	-	4/0 Stranded	2Q	4
ECRV102Q4DB*	10	-	4/0 Stranded	2Q	4
ECRV102Q4U	10	-	4/0 Stranded	2Q	4
ECRV121T4U	12	-	#2 Solid, Tinned	1T	4
ECRV122Q4U	12	-	4/0 Stranded	2Q	4
ECRE152Q4U	15	-	4/0 Stranded	2Q	4
ECRE201T4U	20	-	#2 Solid, Tinned	1T	4
ECRE202G4U	20	-	2/0 Stranded	2G	4
ECRE202Q4U	20	-	4/0 Stranded	2Q	4
ECRE402Q4U	40	-	4/0 Stranded	2Q	4
ECRE401T4D	40	-	#2 Solid, Tinned	1T	4

- \* Includes rod assembly only.
- \* All chemical ground rod kits contain the following components, except part numbers ending in "B".
- \* Contact ERICO for additional configurations.

## Kit Components

Part No.	Description
GEM25A	25 lb (11.36 kg) bag of GEM – Ground Enhancement Material
BENTFILL	50 lb (22.68 kg) bag of Bentonite backfill
T416B	High-density polyethylene inspection well for no traffic areas

## Copper Pigtail Cable Codes

Conductor Code	Conductor Size (AWG)	Conductor Code	Conductor Size (AWG)
1T	#2 Solid Tinned	2Q	4/0 Stranded
2C	1/0 Stranded	2V	250 MCM Stranded
2G	2/0 Stranded	3Q	500 MCM Stranded

## Salt Mix

Part No.	Description
ECRCHM15LB	Chemical Ground Rod Salt Mix, 15-lb package (6.8 kg)

## Vertical Installation Horizontal Installation

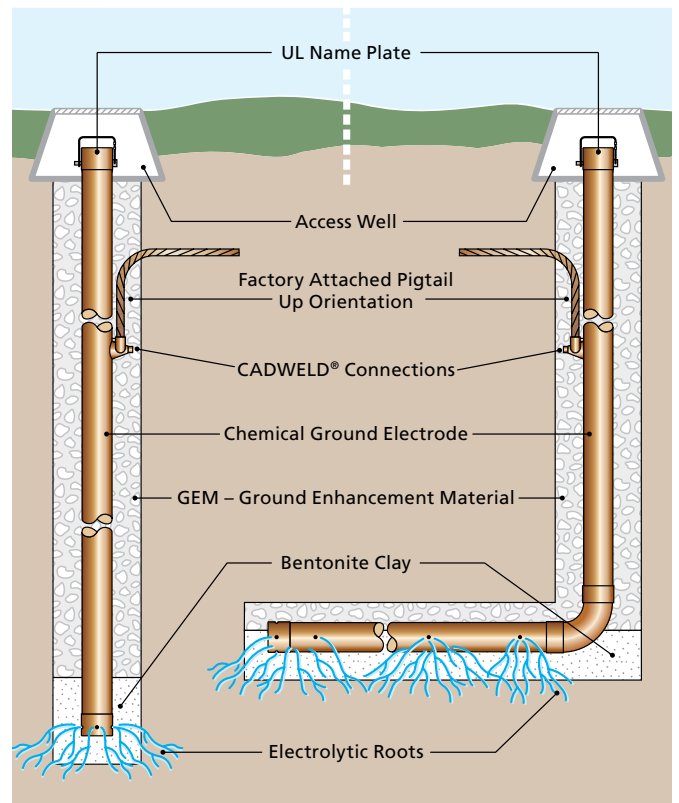

Chemical Ground Electrodes can be installed either vertically or horizontally. Chemical electrodes are available in a range of standard and custom configurations. They can be purchased individually or part of a complete kit.

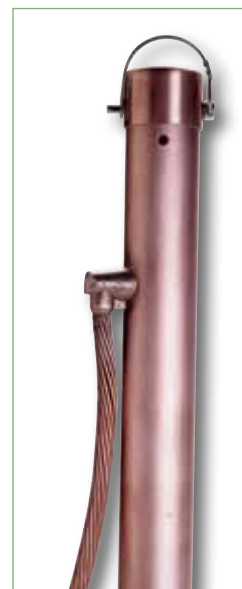

Vertical Installation

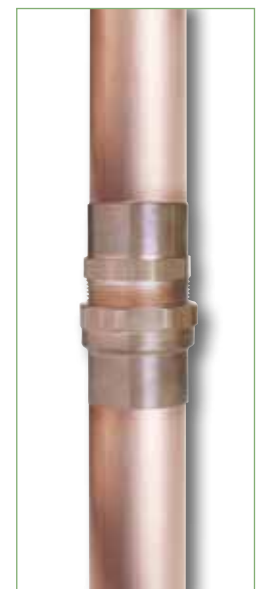

Chemical Ground Electrodes can be extended using threaded couplers.

# Ground Enhancement Material



## Ground Enhancement Material (GEM)

Developed in 1992, Ground Enhancement Material (GEM) is a superior conductive material that solves your toughest grounding problems. It is the ideal material to use in areas of poor conductivity, such as rocky ground, mountain tops and sandy soil. GEM is also the answer in situations where ground rods can't be driven or where limited land area makes adequate grounding difficult with conventional methods. Only rarely do grounding system designers and contractors get to work on a site with good grounding conditions. Even under ideal circumstances, soil structure can vary and make it difficult to achieve uniform, low levels of resistivity across a wide area. Under almost all soil conditions, the use of a ground enhancement material will improve grounding effectiveness. Some are permanent and require no maintenance. When selecting a ground enhancement material be sure it is compatible with the ground rod, conductor and connection material.

To improve the conductivity of a grounding system, ERICO recommends using Ground Enhancement Material (GEM).

GEM is a low-resistance, non-corrosive, carbon dust based material that helps improve grounding effectiveness, especially in areas of poor conductivity. GEM contains cement, which hardens when set to provide a permanent, maintenance-free, low-resistant grounding system that never leaches or washes away. GEM does not adversely affect soil and will not leach ions or contaminate ground water. It meets all EPA requirements for landfill (USA). A Material Safety Data Sheet (MSDS) is available on request.



## Features and Benefits

GEM helps reduce earthing resistance and maintains low resistance permanently. GEM helps provide conductivity for the life of the grounding system.

### GEM is *effective*

- Dramatically reduces earth resistance and impedance measurements
- Maintains constant resistance for the life of the system once in its set form
- Performs in all soil conditions even during dry spells

### GEM is *easy to use*

- Easy-to-handle 25 lb (11.36 kg) bags or 25 lb bucket (GEM25ABKT)
- Requires one person to install
- Can be easily mixed into a slurry
- Solidifies into a conductive cement in three days
- May reduce the size of the grounding system where conventional methods are unsatisfactory
- Reduces vandalism (ground rods cannot be easily removed when set in concrete)

### GEM is *permanent*

- Does not dissolve, decompose or leach out with time
- Does not require periodic charging treatments or replacements
- Does not require maintenance
- Does not require the continuous presence of water to maintain its conductivity



ERICO provides 25 lbs of Ground Enhancement Material (GEM) in a convenient, easy to handle bucket container. Just pour the required amount of clean-potable water into the bucket and mix to create a slurry form. Then proceed to pour the slurry mixture into the hole or trench.

Part Number	Description
GEM25A	25-lb. (11.36 kg) bag with handles
GEM25ABKT	25-lb. (11.36 kg) plastic bucket with locking lid

For more information, contact your local ERICO sales representative for a quote. You can reference the GEM part numbers.

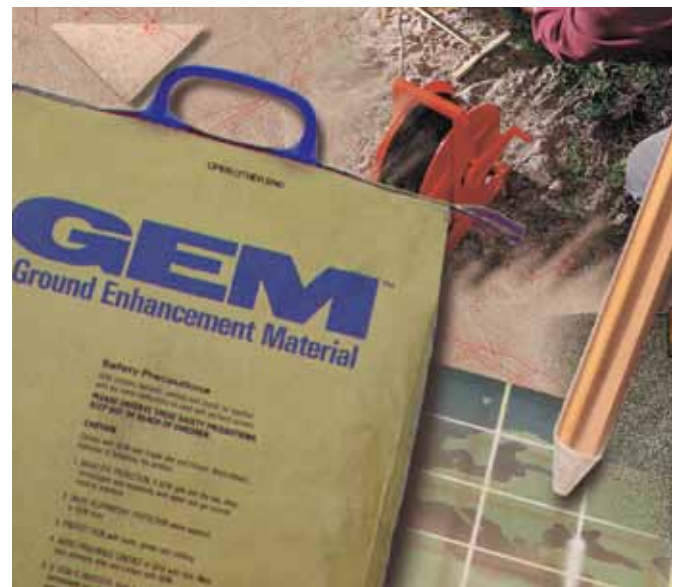

# Ground Enhancement Material

## Trench Installation:

1. Premix GEM into a slurry form. Use 1.5 to 2 gallons (5.7 to 7.6 liters) of clean-potable water per bag or bucket of GEM. To mix GEM into a slurry form, use a standard cement mixer or mix in a mixing box, wheelbarrow, etc. Use 1.5 to 2 gallons (5.7 to 7.6 liters) of clean-potable water per bag of GEM. Do not mix GEM with salt water.
2. Spread out enough GEM to uniformly cover bottom of trench—about 1 inch (2.5 cm) deep. (See Table)
3. Place conductor on top of GEM. (See Note 1)
4. Spread more GEM on top of conductor to completely cover conductor – about 1 inch (2.5 cm) deep. Allow GEM to harden. Wait 30 minutes to one hour before filling the trench with soil backfill.
5. Carefully cover the GEM with soil to a depth of about 4 inches (10 cm), making sure not to expose the conductor.
6. Tamp down the soil, then fill in the trench.

**Note 1:** Wait for the GEM to harden, about 15 to 20 minutes, before placing the conductor on top of the GEM. You must apply 4 inches (10 cm) of insulating material to the conductors and ground rods exiting the GEM, starting 2 inches (5 cm) inside the GEM.

**Note 2:** Excess standing water must be removed from trench.

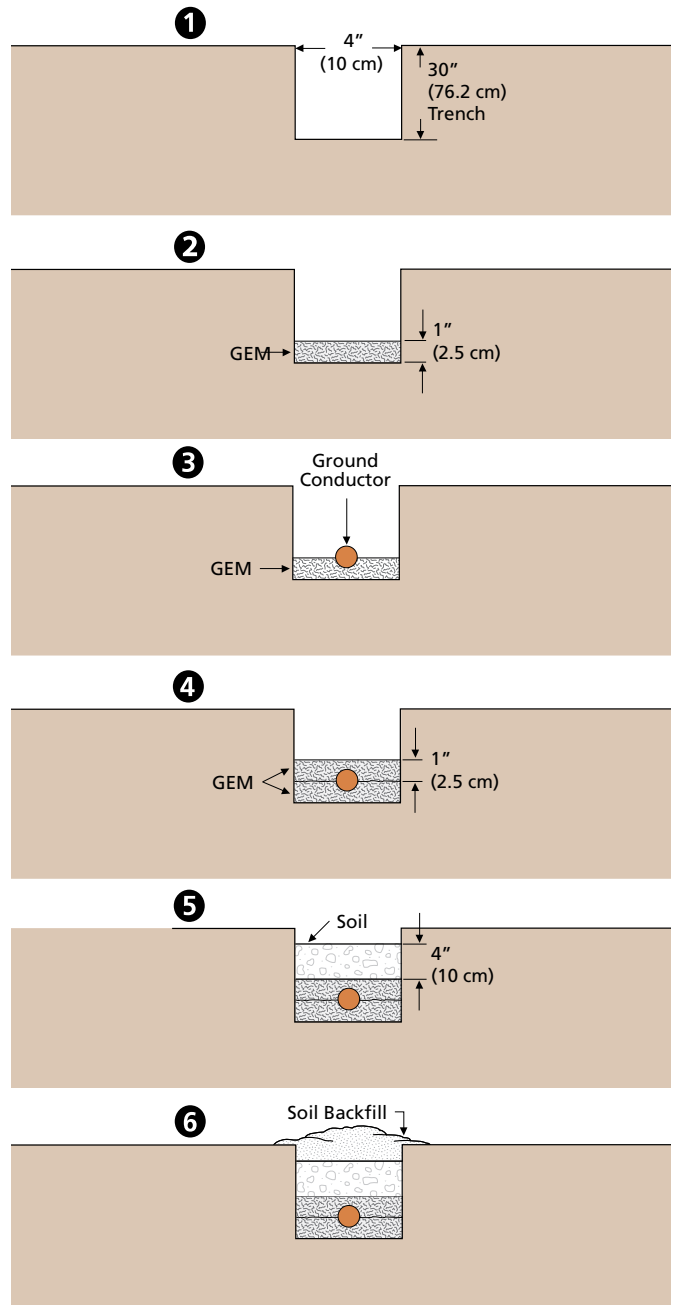

## Estimated linear feet of ground conductor covering with each bag of GEM.

Trench Width In (Cm)	Total Thickness of GEM							
	1 in (2.54 cm)		2 in (5.08 cm)		3 in (7.62 cm)		4 in (10.16 cm)	
4 (10.0)	14.0 ft	35.6 cm	7 ft	17.8 cm	4.7 ft	12 cm	3.5 ft	8.8 cm
6 (15.2)	9.3 ft	23.6 cm	4.7 ft	12 cm	3.1 ft	7.8 cm	2.3 ft	5.8 cm
8 (20.3)	7.0 ft	17.8 cm	3.5 ft	8.8 cm	2.3 ft	5.8 cm	1.8 ft	4.6 cm
10 (25.4)	5.6 ft	14.2 cm	2.8 ft	7.0 cm	1.9 ft	4.8 cm	1.4 ft	3.6 cm
12 (30.5)	4.7 ft	12 cm	2.3 ft	5.8 cm	1.6 ft	4 cm	1.2 ft	3 cm

A 25-pound bag of GEM will cover 7 linear feet (2.1 m) of conductor length for a 4-inch-wide (10 cm), 2-inch-thick (5 cm) covering 1 inch (2.5 cm) below and 1 inch (2.5 cm) above conductor, based on a density of 63.5 lb/cu. ft.



## Ground Rod Backfill Installation:

1. Auger a 3-inch (7.5 cm) or larger diameter hole to a depth of 6 inches (15 cm) shorter than the length of the ground rod.
2. Place ground rod into augered hole and drive 1 foot (30 cm) (if possible) into bottom of the hole. The top of the ground rod will be approximately 6 inches (15 cm) below grade. At this time, make any connections to ground rod using CADWELD® connections. (See Note 1)
3. Premix GEM into a slurry form. Use 1.5 to 2 gallons (5.7 to 7.6 liters) of clean-potable water per bag or bucket of GEM.
4. Pour the appropriate amount of GEM (see table) around the ground rod. To ensure the GEM material completely fills the hole, tamp around the ground rod with a pole. Wait 30 minutes to 1 hour before filling the hole with soil backfill.
5. Fill remainder of augered hole with soil removed during augering. For various augered-hole diameters and depths, see the table below.

**Note 1:** 4 inches (10 cm) of insulating material should be applied to the conductors and ground rods exiting the GEM, starting 2 inches (5 cm) inside the GEM.

**Note 2:** Excess standing water must be removed from the hole.

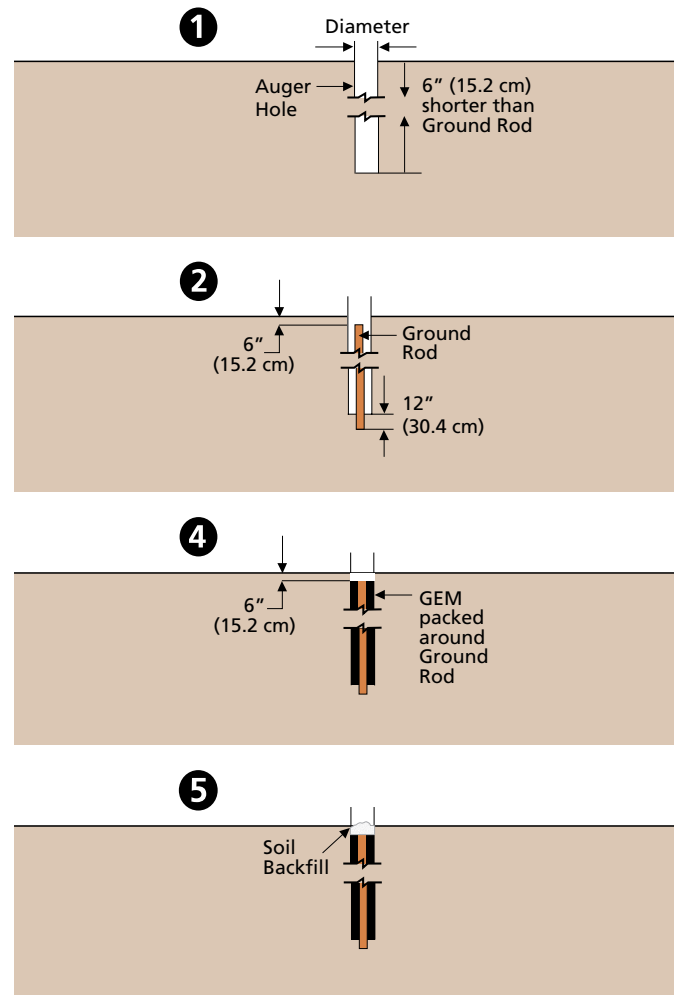

## Estimated bags of GEM for backfilling around ground rods to a density of 63.5 lb/ft<sup>3</sup>

Diameter of Hole In (Cm)	Depth of Hole*						
	6 ft (1.83 m)	7 ft (2.13 m)	8 ft (2.44 m)	9 ft (2.74 m)	17 ft (5.18 m)	19 ft (5.79 m)	20 ft (6.10 m)
3 (7.6)	2 bags	2 bags	2 bags	2 bags	4 bags	4 bags	4 bags
4 (10)	2 bags	3 bags	3 bags	3 bags	6 bags	7 bags	7 bags
5 (12.7)	3 bags	4 bags	4 bags	5 bags	9 bags	10 bags	10 bags
6 (15.2)	5 bags	5 bags	6 bags	7 bags	13 bags	14 bags	15 bags
7 (17.8)	6 bags	7 bags	8 bags	9 bags	17 bags	19 bags	20 bags
8 (20.3)	8 bags	9 bags	11 bags	12 bags	22 bags	25 bags	26 bags
9 (22.8)	10 bags	12 bags	13 bags	15 bags	28 bags	31 bags	32 bags
10 (25.4)	12 bags	14 bags	16 bags	18 bags	34 bags	38 bags	40 bags

\* 8-foot (2.44 m) minimum rod length required to be in contact with the soil (or GEM), per NEC® 250-83-C.

**Note:** To mix GEM into a slurry form, use a standard cement mixer or mix in a mixing box, wheelbarrow, etc. Use 1.5 to 2 gallons (5.7 to 7.6 liters) of clean-potable water per bag of GEM. Do not mix GEM with salt water. For storage and safety precautions, see product packaging.

# Grounding Accessories

## Light Weight Polymer Concrete Inspection Wells

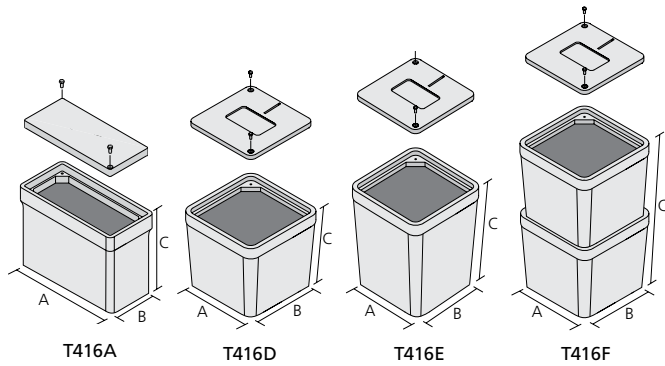

Part No.	A (in)	B (in)	C (in)	Cover Weight (lbs)	Weight of Box Base with Inserts (lbs)
T416A	21.5	14	18	35	36
T416D	12.875	12.875	12	11	15
T416E	12	12	18	11	17
T416F	12.875	12.875	23	11	30

Product specifications subject to change without notice.



## High Density Polyethylene Inspection Wells (HDPE)

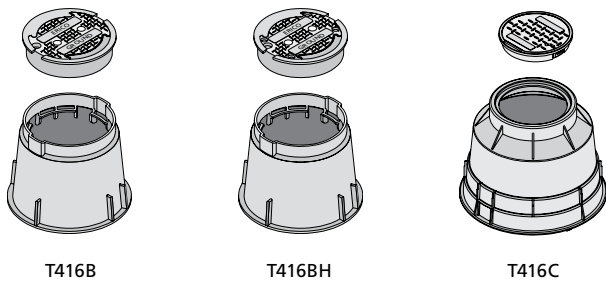

Part No.	Diameter at grade level (in)	Outside Diameter (in)	Depth (in)	Cover Weight (lbs)	Weight of Box Base with Inserts (lbs)
T416B	9.125	13	10.25	1.5	3
Stainless steel lock bolt (3/8" - 16 x 1-3/4"); boxes and covers nest in 3.25" increments; 2 knockouts per box (3.5" x 1.5"); color: green					
T416BH	9.125	13	10.25	1.5	3
Includes 4 additional 1/2" bolts on cover. Stainless steel lock bolt (3/8" - 16 x 1-3/4"); boxes and covers nest in 3.25" increments; 2 knockouts per box (3.5" x 1.5"); color: green					
T416C	11	24.5	18.25	4.2	13.4
Pipe slot (2 places); color: black T416CKEY: Key for T416C Inspection Well					



## Plastic Inspection Wells



PIT03

PIT05

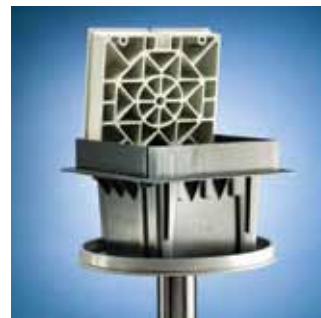

WGRS200

IP900C

Part No.	Dimensions (in) length x width x depth	Weight of Box Base with Inserts (lbs)
PIT03	9.84 x 7.87 x 8.46	3
Includes locking pin and key		
PIT05	9.76 x 9.76 x 8.27	5
UV-stabilized against degradation by sunlight; non-brittle to prevent cold weather damage		
WGRS200	-	9.5
Double flange earth seal with PIT05		
IP900C	12.8 x 12.8 x 5.71	60
Concrete Inspection Pit		





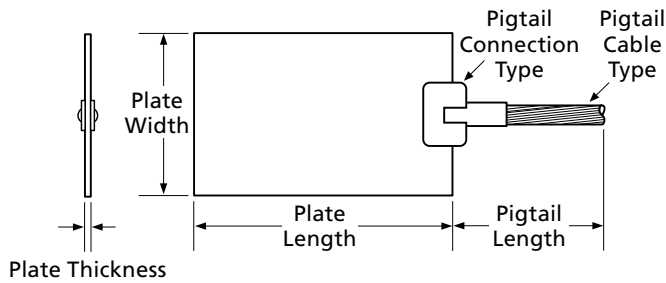

## Terminated Pigtails

**Part Number: GPE C E A H 024 1L 024 (T)**

- Ground Plate Electrode Material → **G**
- Pigtail Connection Type → **P**
- Plate Thickness Code (Stock Tolerance) → **E**
- Plate Width Code → **A**
- Plate Length Code (inches) (3 digits required) → **H024**
- Pigtail Cable Type (ERICO Cable Code) → **1L**
- Pigtail Length (inches) → **024**
- T = Tinned → **(T)**

**Example: GPECEAH0241L024**

## CADWELD® Cable Codes – Bare, Concentric Stranded Copper Conductor

2Q	4/0 Stranded	1Y	#1 Stranded	1H	#6 Stranded
2L	3/0 Stranded	1V	#2 Stranded	1E	#8 Stranded
2G	2/0 Stranded	1Q	#3 Stranded	1B	#10 Stranded
2C	1/0 Stranded	1L	#4 Stranded		

## CADWELD Cable Codes – Bare, Solid Copper Conductor

2P	4/0 Solid	1X	#1 Solid	1G	#6 Solid
2K	3/0 Solid	1T	#2 Solid	1D	#8 Solid
2F	2/0 Solid	1P	#3 Solid	1A	#10 Solid
2B	1/0 Solid	1K	#4 Solid		

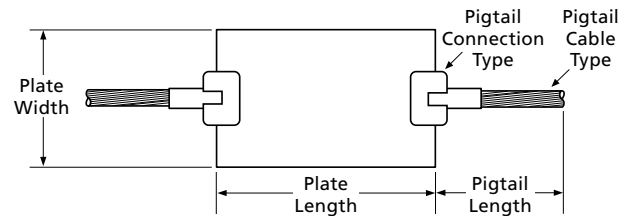

## Through Pigtail

## Copper Ground Plates with Terminated, Welded Pigtails

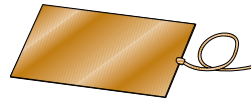

Material	
A	Steel (HRS M1020)
B	Stainless Steel (SS304)
C	Copper (C11000)
D	Galvanized Steel

Pigtail Connection Type	
C	Continuous (2 x "LJ" ERICO Conn.)
E	End ("LJ" ERICO Conn. Style)
N	No Pigtail

Plate Width Code			
A	1"	J	18"
B	2"	K	24"
C	3"	L	30"
D	4"	M	36"
E	5"	N	42"
F	6"	P	48"
G	9"	Q	17"
H	12"	R	10"

Plate Thickness Code	
A	1/32" (Min. for Lightning – Cu)
B	1/16" (Min. for Power – Cu)
C	3/32"
D	1/8"
E	1/4" (Min. for Power – Stl.)
F	3/8"
G	1/2"
H	1/64" (26 Gauge)
J	3/16"

Part No.	Thickness (in)	Width (in)	Length (in)	Cable Code	Cable Size	Pigtail Length (in)
GPECEAH0241L024	1/32	12	24	1L	#4 Stranded	24
GPECEAH0241T024	1/32	12	24	1T	#2 Solid	24
GPECEAH0242Q024	1/32	12	24	2Q	4/0 Stranded	24
GPECEAJ0181G024	1/32	18	18	1G	#6 Solid	24
GPECEAJ0182Q024	1/32	18	18	2Q	4/0 Stranded	24
GPECEAJ0241G024	1/32	18	24	1G	#6 Solid	24
GPECEAK0241G024	1/32	24	24	1G	#6 Solid	24
GPECEAK0241H024	1/32	24	24	1H	#6 Stranded	24
GPECEAK0241T024	1/32	24	24	1T	#2 Solid	24
GPECEAK0241V024	1/32	24	24	1V	#2 Stranded	24
GPECEAK0241Y024	1/32	24	24	1Y	#1 Stranded	24
GPECEAK0242G024	1/32	24	24	2G	2/0 Stranded	24
GPECEAK0242Q024	1/32	24	24	2Q	4/0 Stranded	24
GPECEAK0242V024	1/32	24	24	2V	250 MCM Stranded	24
GPECEAM0362Q024	1/32	36	36	2Q	4/0 Stranded	24
GPECEAP0481H024	1/32	48	48	1H	#6 Stranded	24
GPECEBH0121V024	1/16	12	12	1V	#2 Stranded	24
GPECEBH0122G024	1/16	12	12	2G	2/0 Stranded	24
GPECEBH0241K024	1/16	12	24	1K	#4 Solid	24
GPECEBH0242G024	1/16	12	24	2G	2/0 Stranded	24
GPECEBH0242L024	1/16	12	24	2L	3/0 Stranded	24
GPECEEK0242Q060	1/4	24	24	2Q	4/0 Stranded	60
GPECEEK0361T024	1/4	24	36	1T	#2 Solid	24

Contact ERICO for additional product configurations.

# Ground Plates

## Copper Ground Plates with Welded, Through Pigtails

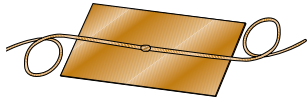

Part No.	Thickness (in)	Width (in)	Length (in)	Cable Code	Cable Size	Pigtail Length (in)
GPECCA0242Q024	1/32	12	24	2Q	4/0 Stranded	24
GPECCAJ0181V024	1/32	18	18	1V	#2 Stranded	24
GPECCA0242Q024	1/32	18	24	2Q	4/0 Stranded	24
GPECCA0361L024	1/32	18	36	1L	#4 Stranded	24
GPECCA0241L024	1/32	24	24	1L	#4 Stranded	24
GPECCA0241T024	1/32	24	24	1T	#2 Solid	24
GPECCAM0362C024	1/32	36	36	2C	1/0 Stranded	24
GPECCAM0362Q024	1/32	36	36	2Q	4/0 Stranded	24
GPECCBH0122Q024	1/16	12	12	2Q	4/0 Stranded	24
GPECCBH0242G024	1/16	12	24	2G	2/0 Stranded	24
GPECCBK0242C036	1/4	24	24	2C	1/0 Stranded	36

## Copper Ground Plate with Bent Corners and Welded Pigtail



Part No.	Thickness (in)	Width (in)	Length (in)	Cable Code	Cable Size	Pigtail Length (ft)
GPECEHX1	.064	17	17	1G	#6 Solid	10

## Copper Ground Plates Without Pigtailed

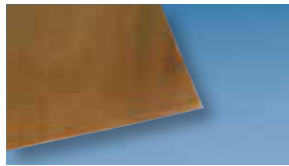

Part No.	Thickness (in)	Width (in)	Length (in)
GPECNAK024	1/32	24	24
GPECNDF006	1/8	6	6
GPECNEB024	1/4	2	24
GPECNEK024	1/4	24	24
GPECNEM040	1/4	36	40

## Copper Ground Plates with Cable Attachments



LPC750  
LPC751  
LPC752

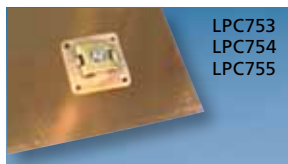

LPC753  
LPC754  
LPC755

- Copper ground plates made from 20 gauge thick, high conductivity copper sheet
- Cable attachment (LPC535L) securely fastened to plate

Part No.	Thickness (gauge)	Width (in)	Length (in)	Number of Cable Attachments
LPC750	20	12	24	2
LPC751	20	18	18	2
LPC752	20	36	36	2
LPC753	20	12	24	1
LPC754	20	18	18	1
LPC755	20	36	36	1

## Copper Utility Pole Bottom Plates



EGP100



EGP100HL

Part No.	Description	Thickness (in)	Diameter (in)	Conductor Size Range
EGP100	Utility Pole-Bottom Plate with Lug*	.025	7.5	#14 Solid – #4 Stranded
EGP100HL	Utility Pole-Bottom Plate with ERITECH® HAMMERLOCK Connector	.025	7.5	#14 Solid – #4 Stranded

\* RUS Approved

## Copper Utility Ground Plates

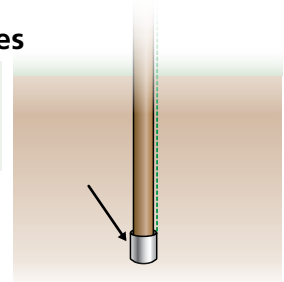

Part No.	Description	Thickness (in)	Width (in)	Length (in)
UGP719	Utility Ground Plate with SRGC46 Connector*	1/16	7.5	19.25
UGP719BP5	Utility Ground Plate with Connector, quantity of 5 per package	1/16	7.5	19.25
UGP719SBP5	Utility Ground Plate with ESB2 Split Bolt	1/16	7.5	19.25
UGP738	Utility Ground Plate with SRGC46 Connector*	1/16	7.5	38.5
UGP738P5	Utility Ground Plate with SRGC46 Connector, quantity of 5*	1/16	7.5	38.5
UGP738SBP5	Utility Ground Plate with ESB2 Split Bolt	1/16	7.5	38.5

\* SRGC46 Connector (for Signal Reference Grids) can be used for #4 solid – #6 stranded AWG.

## Steel Ground Plates



- CSA Listed for Canada and US

Part No.	Description	Thickness (in)	Width (in)	Length (in)
EGGP	Galvanized Steel Ground Plate, without Connector	1/4	10	16
EGGPC	Galvanized Steel Ground Plate, with HDC58 Connector	1/4	10	16



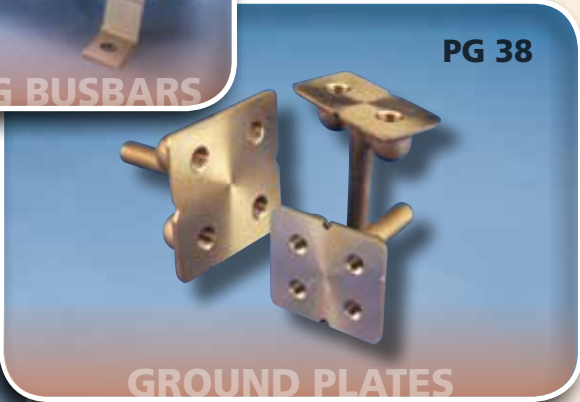

# Grounding Bus Bars

Proper bonding is essential to create an equipotential plane between service grounds and equipment during fault and transient conditions. This equipotential plane provides a near zero voltage differential and serves to protect people and equipment during these events. The most popular bonding product in use today is the ground bar or bonding bar. Ground bars provide a convenient, single-point grounding and bonding location. Conductors are welded to the bar

using a CADWELD® exothermic connection or are mechanically fastened by using lugs.

ERICO can design and manufacture custom bars. In addition, the breadth of the product offering includes TMGB bars, which meet the requirements of TIA®/EIA® 607 and conform to BICSI® recommendations. Our perimeter bus system allows for fast and easy field installation of halo and other perimeter grounding schemes.

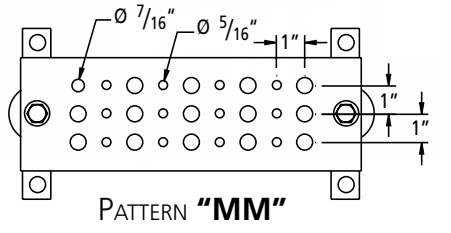
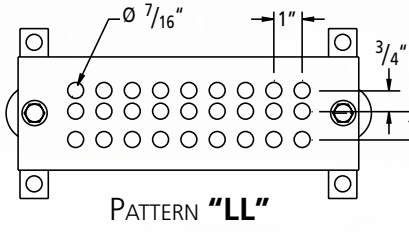
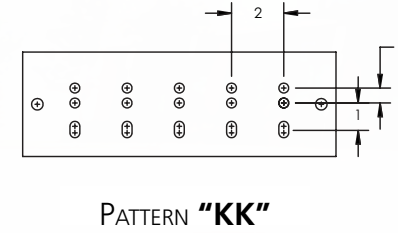
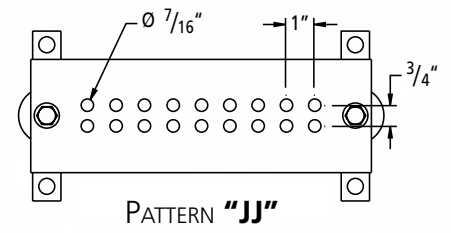
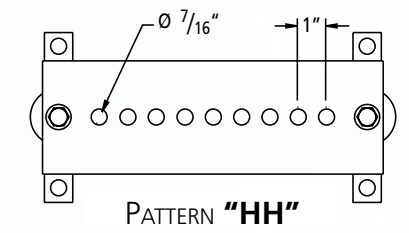
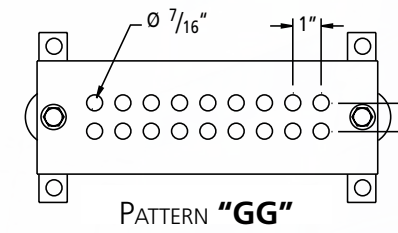
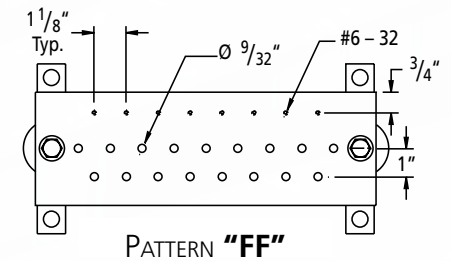
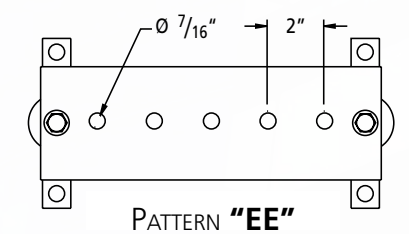
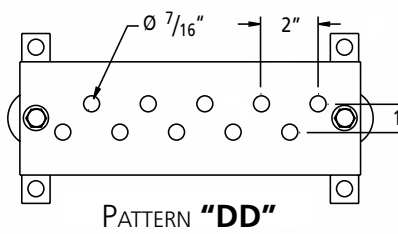
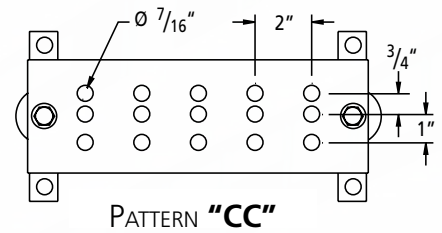
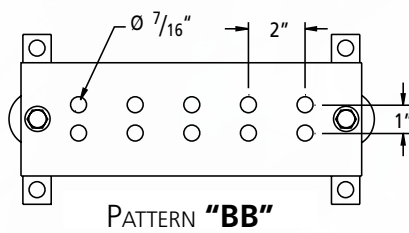
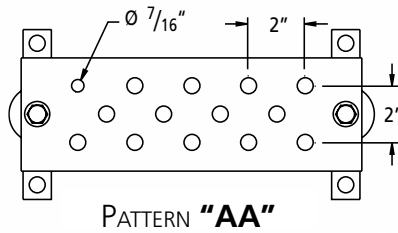

GROUNDING BUS BARS

EQUIPOTENTIAL BONDING



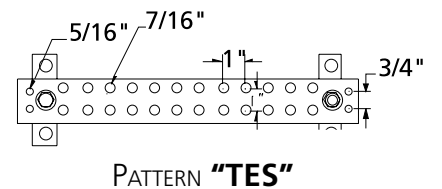
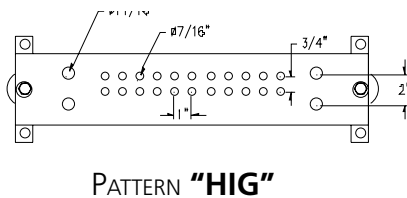
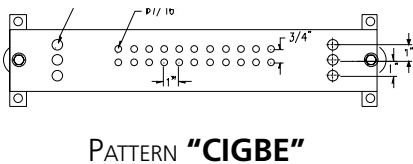
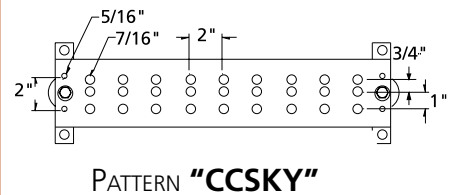
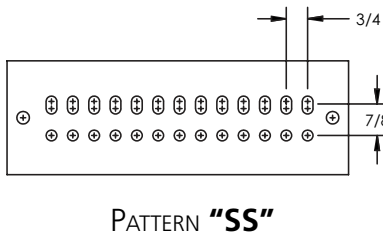
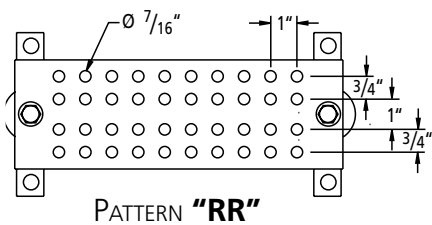
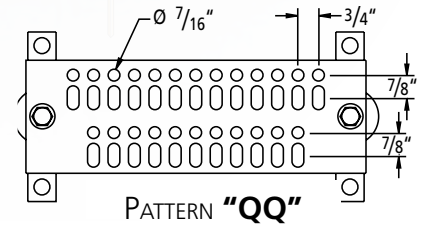
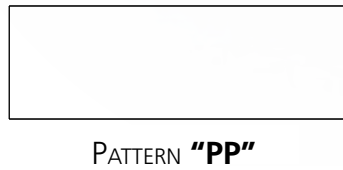
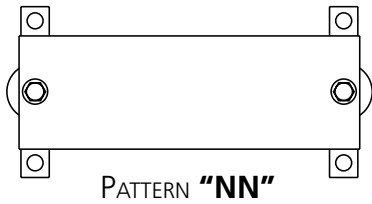
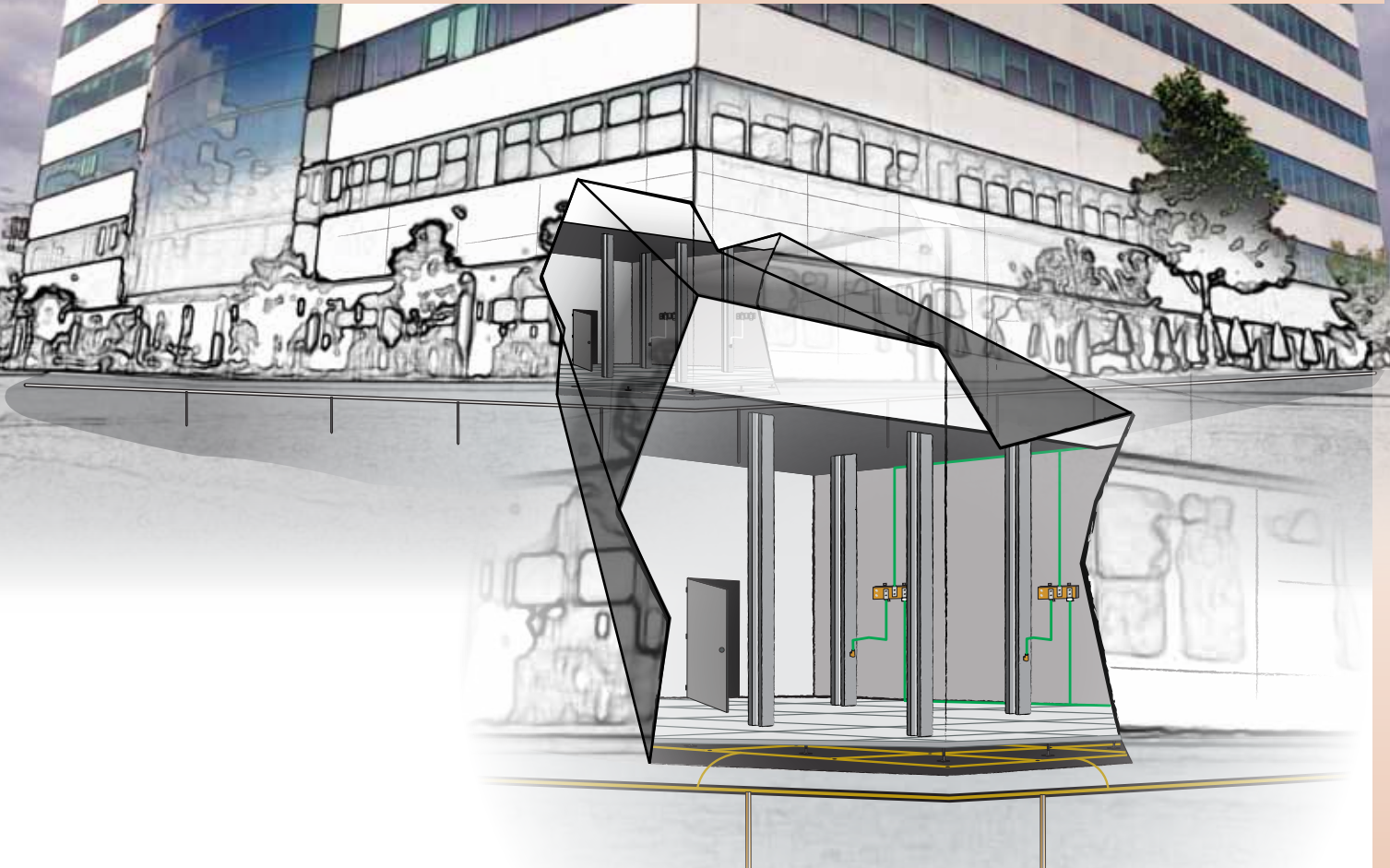

# Grounding Bus Bars

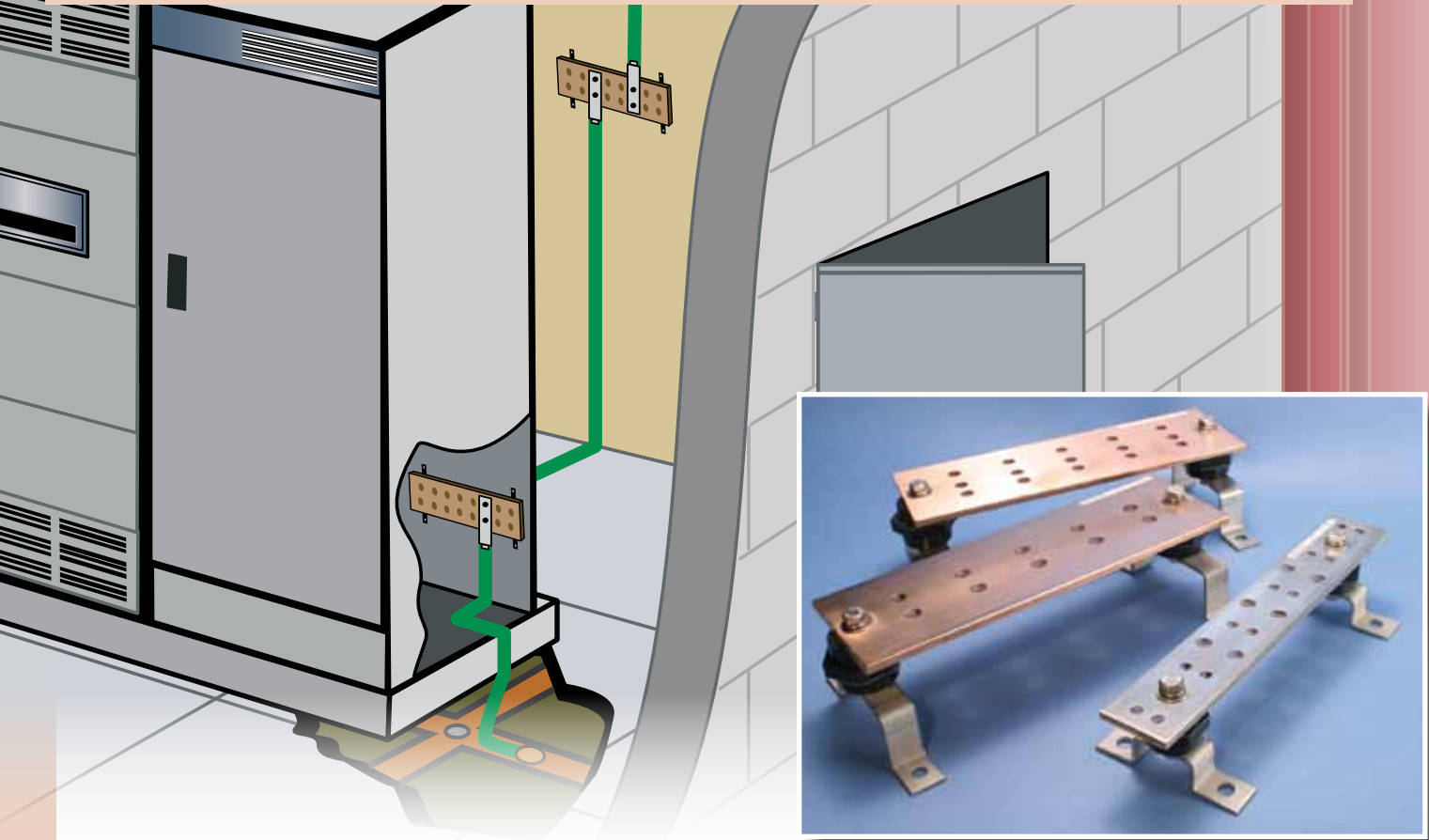

**E G B A 1 4 4 1 2 C C**

**ERITECH  
Ground Bar  
Designator**

**Configuration**

A = Insul & Brkt    C = None (Bar only)  
B = Brkt only        D = Insul only

**Thickness**

18 = 1/8"    58 = 5/8"    12 = 1/2"  
38 = 3/8"    14 = 1/4"    34 = 3/4"

**Width**

1 = 1"    4 = 4"    7 = 7"  
2 = 2"    5 = 5"    8 = 8"  
3 = 3"    6 = 6"    9 = 9"

**Pig Tail Length Ft.** (Empty if none)

A = 1    E = 5    J = 9    N = 16    S = 24    W = 32  
B = 2    F = 6    K = 10    O = 17    T = 25    X = 34  
C = 3    G = 7    L = 11    P = 18    U = 26    Y = 36  
D = 4    H = 8    M = 12    Q = 19    V = 27    Z = 38

**ERICO Cable Code** (Empty if none)

1K = #4 Sol Tin    2C = 1/0    2V = 250 KCM  
1T = #2 Sol Tin    SG = 2/0    3D = 350 KCM  
2L = 3/0    3Q = 500 KCM  
2Q = 4/0    4L = 750 KCM

**Tin Plating**  
(Empty if none)

T = Tinned

**Hole Pattern**

**Length** (rounded to the nearest inch, up to 96 inch max.)

GROUNDING BUS BARS

EQUIPOTENTIAL BONDING



## Commonly Stocked Copper Grounding Bus Bars\* with Insulators & Brackets

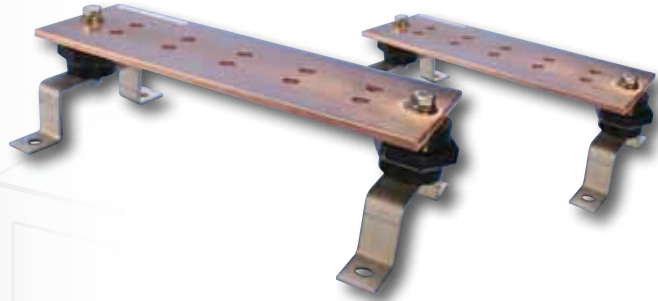

Part No.	Thickness (in)	Width (in)	Length (in)	Hole Pattern
<b>1" wide bar</b>				
EGBA14112EE	1/4	2	12	EE
<b>2" wide bar</b>				
EGBA14212BB	1/4	2	12	BB
EGBA14212EE	1/4	2	12	EE
EGBA14212HH	1/4	2	12	HH
EGBA14212NN	1/4	2	12	NN
EGBA14215JJ	1/4	2	15	JJ
EGBA14224GG	1/4	2	24	GG
EGBA14224NN	1/4	2	24	NN
<b>4" wide bar</b>				
EGBA14410FF	1/4	4	10	FF
EGBA14412AA	1/4	4	12	AA
EGBA14412BB	1/4	4	12	BB
EGBA14412CC	1/4	4	12	CC
EGBA14412GG	1/4	4	12	GG
EGBA14412LL	1/4	4	12	LL
EGBA14412NN	1/4	4	12	NN
EGBA14420CC	1/4	4	20	CC
EGBA14420NN	1/4	4	20	NN
EGBA14424CC	1/4	4	24	CC
EGBA14424LL	1/4	4	24	LL
EGBA14424MM	1/4	4	24	MM
EGBA14424NN	1/4	4	24	NN

\* Also available using pre-tinned copper bar. Add "T" to the part number.

## Mounting Kits



- Include stainless steel hardware, 3/8" fasteners, insulators and brackets
- cULus® listed

Part No.	Description
B548A39*	Mounting kit for steel beam
B548A41	Mounting kit for 1" & 2" wide bars
B548A42	Mounting kit for 3" & 4" wide bars

\* Not UL Listed

## QQ Pattern, Copper and Tinned Copper Grounding Bus Bars with Insulators & Brackets\*

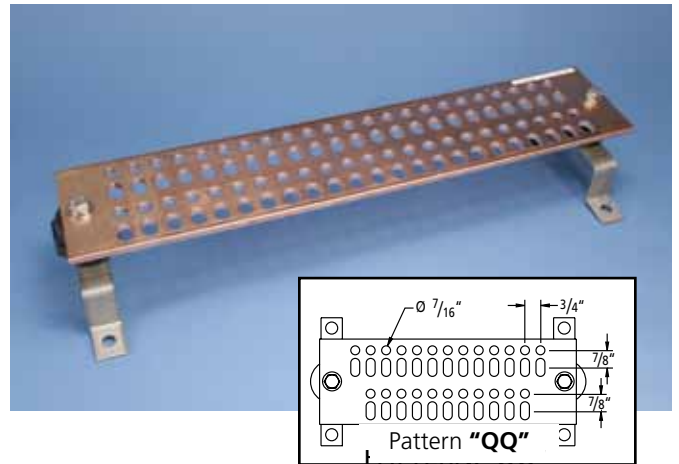

Part No.	Thickness (in)	Width (in)	Length (in)	Hole Pattern	Plating
EGBA14412QQT	1/4	4	12	QQ	Tinned
EGBA14420QQ	1/4	4	20	QQ	Copper
EGBA14420QQT	1/4	4	20	QQ	Tinned
EGBA14424QQ	1/4	4	24	QQ	Copper
EGBA14424QQT	1/4	4	24	QQ	Tinned

## QQ Pattern, Copper & Tinned Copper Grounding Bus Bars (Bar only)\*

Part No.	Configuration	Thickness (in)	Width (in)	Length (in)	Hole Pattern	Plating
EGBC14412QQT	Bar only	1/4	4	12	QQ	Tinned
EGBC14424QQT	Bar only	1/4	4	24	QQ	Tinned
EGBC14420QQ	Bar only	1/4	4	20	QQ	Copper
EGBC14424QQ	Bar only	1/4	4	24	QQ	Copper
EGBC14412QQ	Bar only	1/4	4	12	QQ	Copper

\* Tinned bars with QQ hole pattern are electro-tin plated after holes are punched.

## Ground Bar Insulators



- UL Recognized for Canada and US
- Fiberglass reinforced thermoset polyester

Part No.	Height (in)	Diameter (in) (A)	Thread Size
559600	1	1-1/8	1/4 - 20 x 5/16
559620	1-1/4	1-5/8	1/4 - 20 x 5/16
559660	1-1/2	2	3/8 - 16 x 3/8
559685	2-1/8	2-1/2	5/8 - 11 x 5/8
559686	2-1/4	2-1/2	1/2 - 13 x 5/8
559687	2-1/4	2-1/2	3/8 - 16 x 5/8

# Telecom Ground Bars

## TGB & TMGB Telecom Ground Bars

- UL® listed; meet TIA®/EIA® 607 and conform to BICSI® recommendations
- Comply with NEMA® Standards
- 1/4" thick copper bars
- Type 304 stainless steel brackets and insulators included with ground bar kits
- Electro-tin plating available (add "T" to ground bar part number)
- All bars contain 2 mounting holes (7/16")

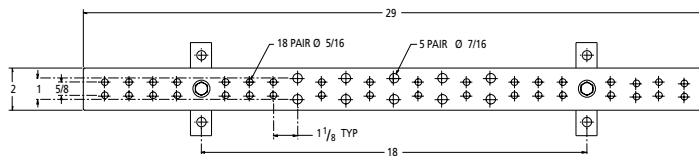
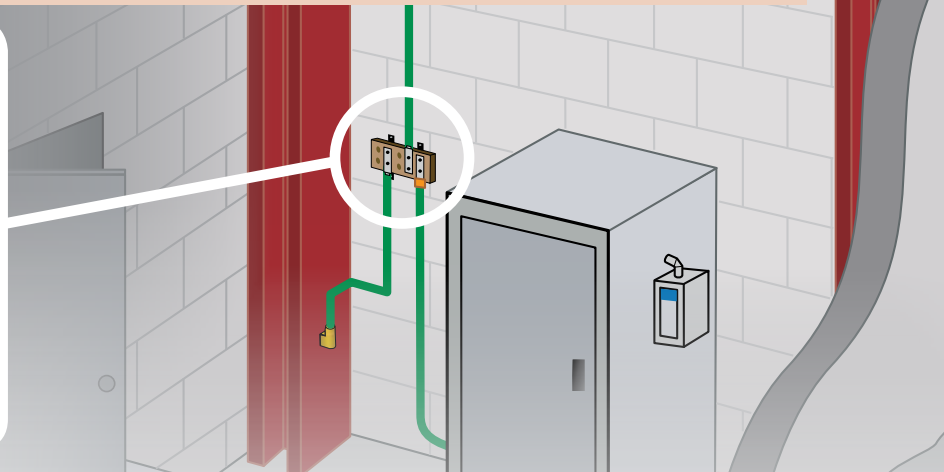

TGBA29L18PT

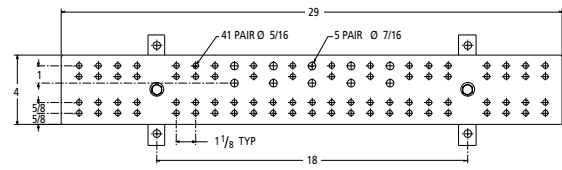

TMGBA29L41PT

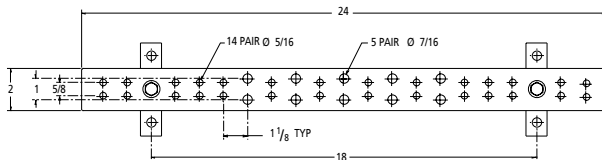

TGBA24L14PT

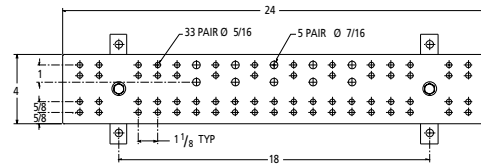

TMGBA24L33PT

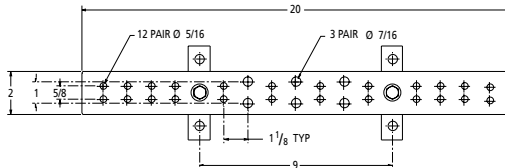

TGBA20L12PT

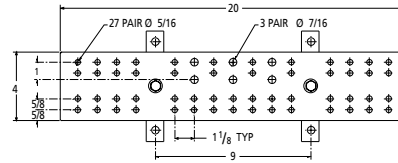

TMGBA20L27PT

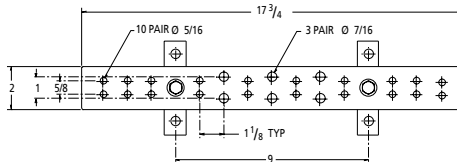

TGBA18L10PT

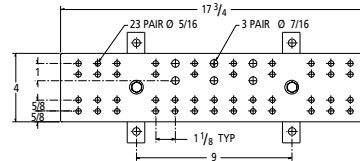

TMGBA18L23PT

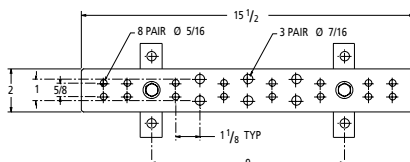

TGBA16L08PT

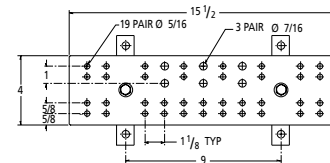

TMGBA16L19PT

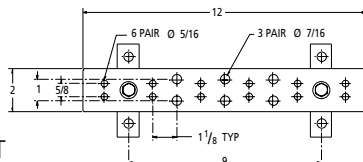

TGBA12L06PT

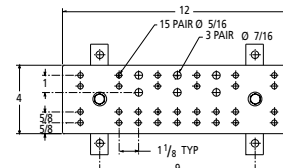

TMGBA12L15PT





## TGB Telecom Ground Bars with Insulators & Brackets



Part No.	Thickness (in)	Width (in)	Length (in)	Plating
TGBA12L06P	1/4	2	12	
TGBA12L06PT	1/4	2	12	Tin
TGBA16L08P	1/4	2	15.5	
TGBA16L08PT	1/4	2	15.5	Tin
TGBA18L10P	1/4	2	17.75	
TGBA18L10PT	1/4	2	17.75	Tin
TGBA20L12P	1/4	2	20	
TGBA20L12PT	1/4	2	20	Tin
TGBA24L14P	1/4	2	24	
TGBA24L14PT	1/4	2	24	Tin
TGBA29L18P	1/4	2	29	
TGBA29L18PT	1/4	2	29	Tin

## TGB & TMGB Telecom Ground Bar Splice Kits

- Includes 2 tinned copper splice plates and stainless steel fasteners

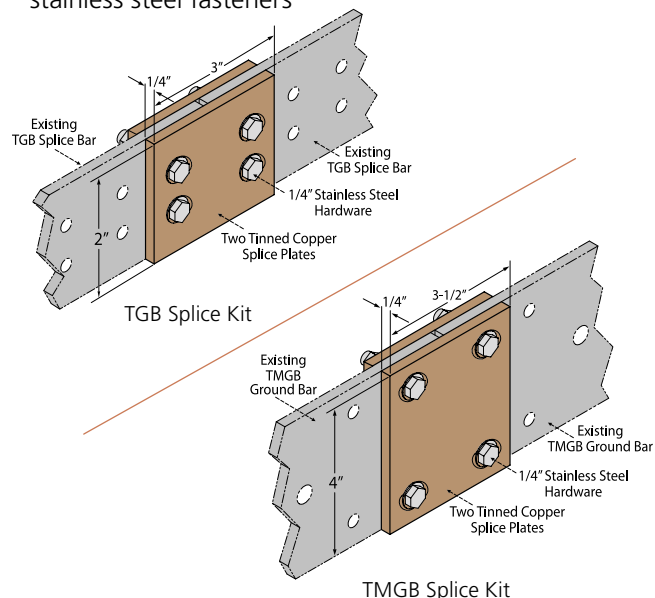

Part No.	Width (in)	Length (in)	Material
TGBSPICEKIT	1/4	2	Tinned Copper
TMGBSPICEKIT	1/4	4	Tinned Copper

## TMGB Telecom Main Ground Bars with Insulators & Brackets



Part No.	Thickness (in)	Width (in)	Length (in)	Plating
TMGBA12L15P	1/4	4	12	
TMGBA12L15PT	1/4	4	12	Tin
TMGBA16L19P	1/4	4	15.5	
TMGBA16L19PT	1/4	4	15.5	Tin
TMGBA18L23P	1/4	4	17.75	
TMGBA18L23PT	1/4	4	17.75	Tin
TMGBA20L27P	1/4	4	20	
TMGBA20L27PT	1/4	4	20	Tin
TMGBA24L33P	1/4	4	24	
TMGBA24L33PT	1/4	4	24	Tin
TMGBA29L41P	1/4	4	29	
TMGBA29L41PT	1/4	4	29	Tin

## Connecting Clamps

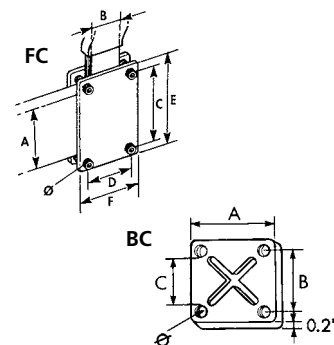
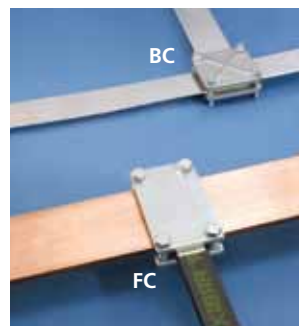

## ERIFLEX® FLEXIBAR Clamp

Part No.	Description	A (in)	B (mm)	C (in)	D (in)	E (in)	F (in)	Diam (mm)	Torque (ft/lbs)
553020	FC 50 x 24	2	20-24	2.32	1.42	2.95	2.05	M8	0.7
553030	FC 50 x 32	2	32	2.32	1.73	2.95	2.36	M8	0.8
553040	FC 50 x 40	2	40	2.32	2.05	2.95	2.68	M8	0.91
553050	FC 80 x 24	3.18	20-24	3.5	1.42	4.13	2.05	M8	0.95
553060	FC 80 x 32	3.18	32	3.5	1.73	4.13	2.36	M8	1.08
553070	FC 80 x 50	3.18	50	3.5	2.44	4.13	3.07	M8	1.41
568700	FC 100 x 32	3.97	32	4.29	1.73	4.92	2.36	M8	1.47
568730	FC 120 x 32	4.4	32	5.08	1.73	4.92	2.36	M8	1.67

## Ribbed-Steel Busbar Clamp

Part No.	Description	A (in)	B (in)	C (in)	Ø (mm)	Torque (ft/lbs)
553200	BC 30	2.2	1.65	1.37	M6	5.16
553210	BC 40	2.6	2.05	1.77	M6	5.16
553220	BC 50	3.26	2.52	2.16	M8	14.75
553230	BC 63	3.66	2.91	2.55	M8	14.75
553250	BC 80	4.64	3.78	3.34	M10	29.5
553260	BC 100	5.67	4.64	4.21	M10	29.5

# Perimeter Grounding Bus Bars

PERIMETER GROUNDING BUS BARS

EQUIPOTENTIAL BONDING

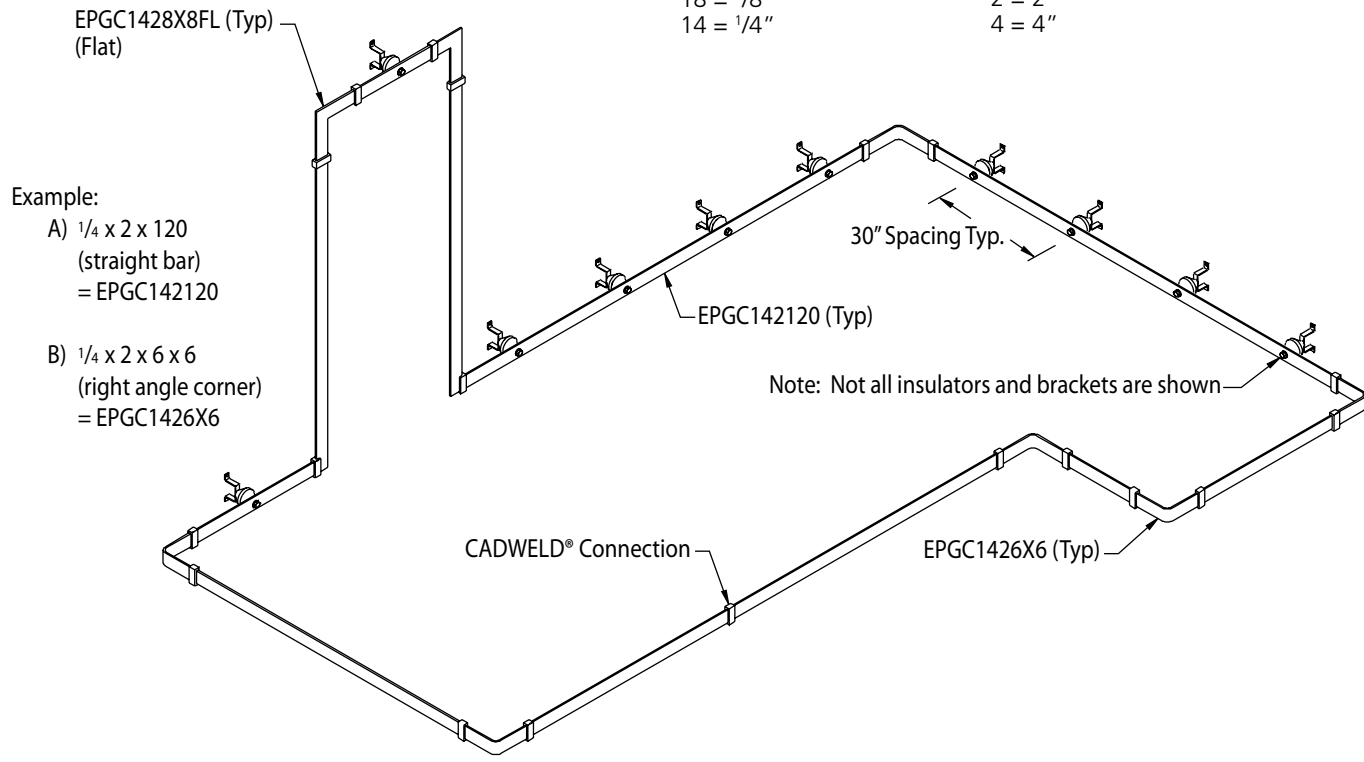
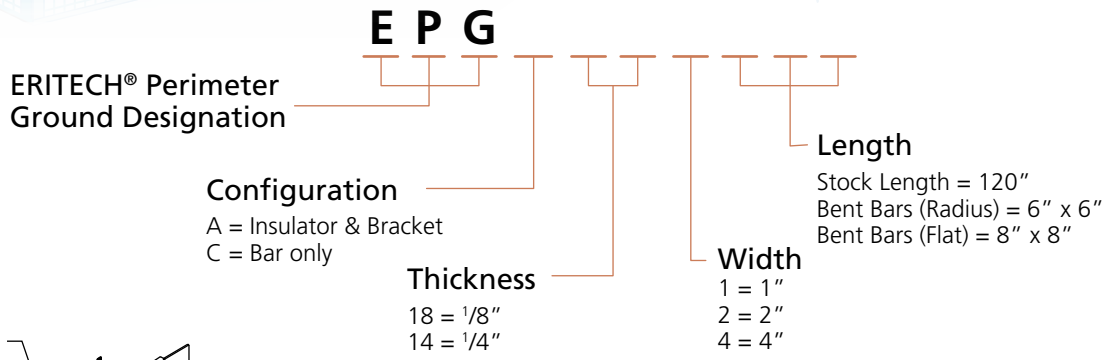
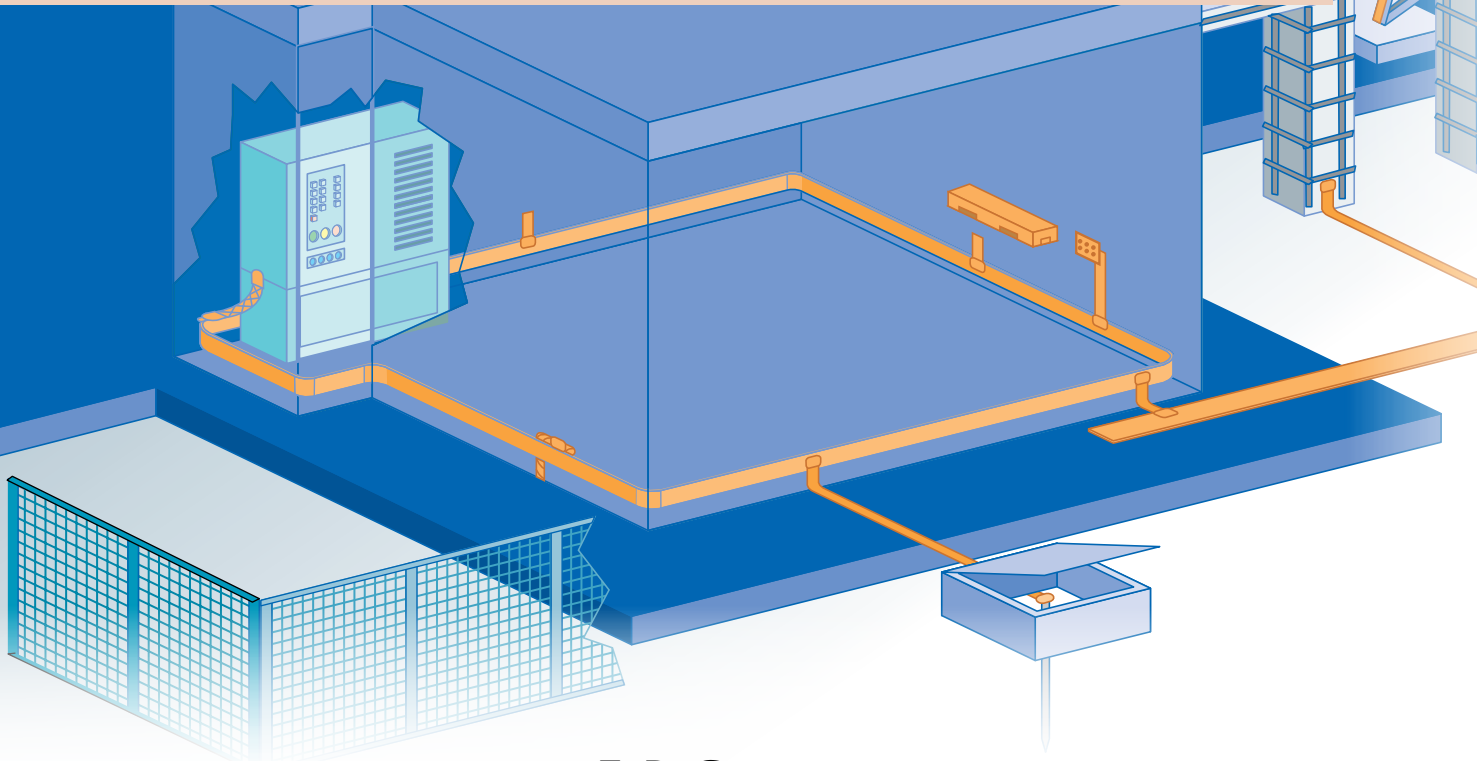

# Perimeter Grounding Bus Bars

## Straight Perimeter Bars with $\frac{7}{16}$ " Holes on 30" Centers

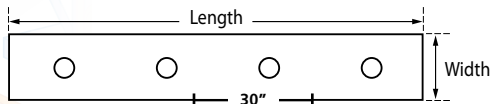

Part No.	Thickness (in)	Width (in)	Length (in)
EPGC141120	1/4	1	120
EPGC142120	1/4	2	120
EPGC142120T*	1/4	2	120
EPGC142144	1/4	2	144
EPGC143120	1/4	3	120
EPGC144120	1/4	4	120
EPGC181120	1/4	1	120
EPGC182120	1/8	2	120
EPGC183144	1/8	3	144
EPGC184120	1/8	4	120

\* Tinned copper bar

## Bent Bus Bars with 90-degree Angle for Corners (6" x 6")

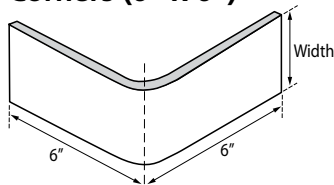

Part No.	Thickness (in)	Width (in)	Length (in)
EPGC1236X6	1/2	3	6
EPGC1416X6	1/4	1	6
EPGC1426X6	1/4	2	6
EPGC1426X6T*	1/4	2	6
EPGC1428X8	1/4	2	8
EPGC1436X6	1/4	3	6
EPGC1446X6	1/4	4	6
EPGC1446X6T*	1/4	4	6
EPGC1816X6	1/8	1	6
EPGC1826X6	1/8	2	6
EPGC1846X6	1/8	4	6

\* Tinned copper bar

## CADWELD® Type BA Connections

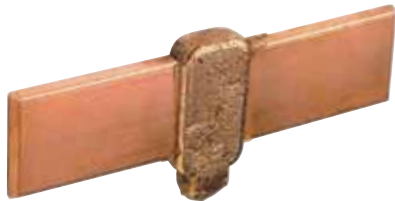

Mold Part No.	Bar Thickness (in)	Bar Width (in)	Welding Material
BACCE	1/8	1	45
BACCH	1/8	2	90
BACCK	1/8	3	200
BADCM	1/8	4	250
BACEE	1/4	1	90
BACEH	1/4	2	200
BADEK	1/4	3	200 (2)
BADEM	1/4	4	500

## Bus Bars with Flat 90-degree Angle for Doors (8" x 8")

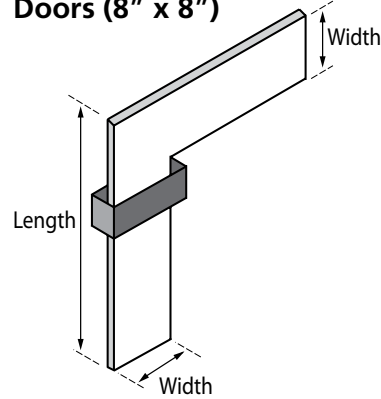

Part No.	Thickness (in)	Width (in)	Length (in)
EPGC1418X8FL	1/4	1	8
EPGC1428X8FL	1/4	2	8
EPGC1448X8FL	1/4	4	8
EPGC1818X8FL	1/8	1	8
EPGC1828X8FL	1/8	2	8
EPGC1848X8FL	1/8	4	8

## FAA Ground Bars

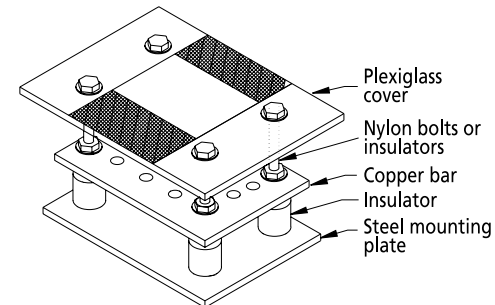

FAA-Style Ground Bar

- FAA ground bars available in many sizes.
- Customer to provide:
  - Ground bar size
  - Hole pattern
  - Plexiglass size
  - Plexiglass markings

## Plexiglass Protective Covers

Part No.	Thickness (in)	Width (in)	Length (in)
B540C130C	1/4	6	14
B540C131C	1/4	6	10
B540C132C	1/4	6	10

\* Specify size. Contact ERICO for quote.

# Equipment Ground Plates

## Cast Ground Plates

- Convenient ground system connection points in concrete structures
- Used for equipment, machinery and structure grounding
- Made from a copper alloy
- Result in current carrying capacity equal to that of the conductor or stud
- Will not loosen or corrode

Use a CADWELD® mold (Type TA or Type SS) when connecting the ERITECH® brand of cast ground plate to the ground conductor. The cast ground plate stud size noted above fits the mold opening for a cable of the same size. Reference CADWELD catalog (A1A) for more information.

Examples:

- Tee connection of 250 cable to B1642Q (4/0 stud size), use mold TAC2V2Q.
- Splice connection of 250 cable to B1642Q, use mold SSC2Q2V.

## Clamp Style Ground Plate

- Cast bronze grounding plate
- Dimensions similar to B164 Series
- Cable connection under bolt tension

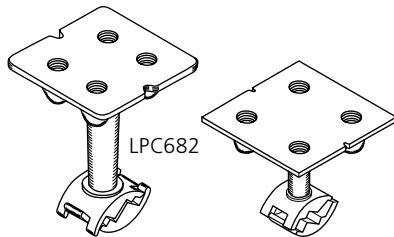

## DB Series

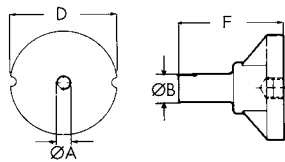

Reference Code	øA	øB (mm)	øD (mm)	F (mm)
DB-10A	M10	16	50	55
DB-12A	M12	16	50	55
DB-16A	M16	16	50	55

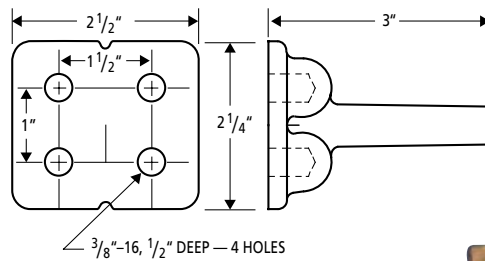

Part No.	Description
B1612Q	Cast ground plate with 4/0 stud
B1613Q	Cast ground plate with 500 MCM stud

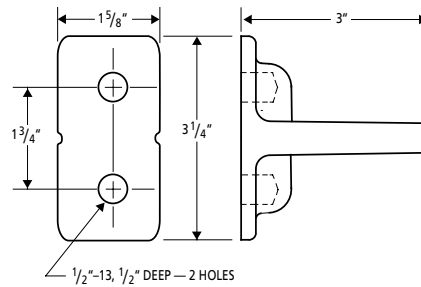

Part No.	Description
B1622Q	Cast ground plate with 4/0 stud

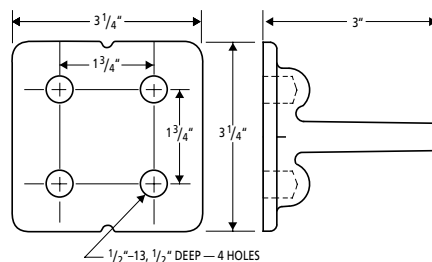

Part No.	Description
B1642Q	Cast ground plate with 4/0 stud
B1643Q	Cast ground plate with 500 MCM stud



EQUIPMENT GROUND PLATE ASSEMBLIES

EQUIPOTENTIAL BONDING



# Equipment Ground Plate Assemblies

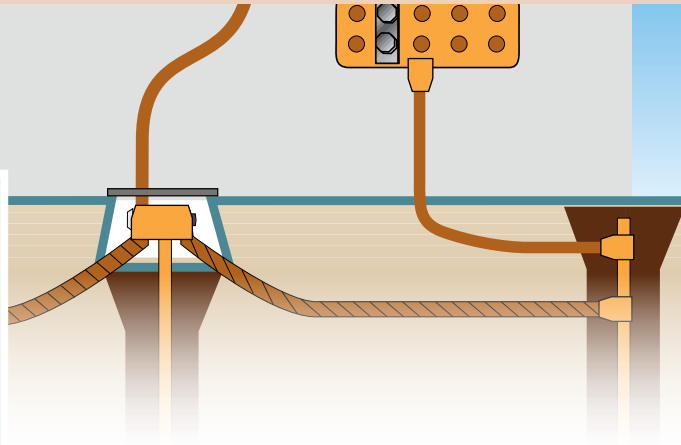
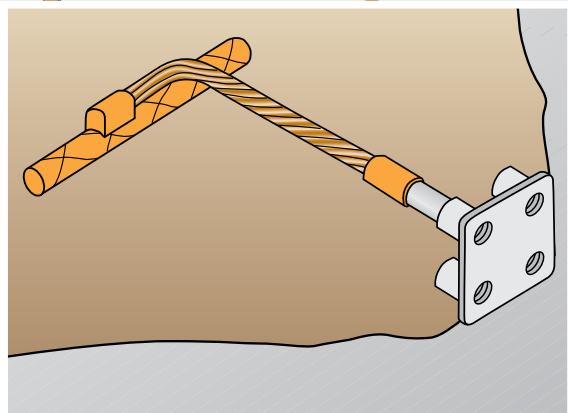

- Assemblies use equipment ground plate parts: B1612Q [A], B1613Q [B], B1622Q [C], B1642Q [D], and B1643Q [E]
- Custom lengths available; contact ERICO for details

## B530 A 2Q 72

### Ground Plate Configuration

RA = "B530"  
 RB = "B531"  
 SS = "B532"  
 TA = "B533"

### Ground Plate Part Number

B1612Q = "A"  
 B1613Q = "B"  
 B1622Q = "C"  
 B1642Q = "D"  
 B1643Q = "E"

### Cable Length (inches)

#### Cable Code

#6 Solid = 1G	1/0 Stranded = 2C	250 MCM Stranded = 2V
#4 Stranded = 1L	2/0 Stranded = 2G	350 MCM Stranded = 3D
#2 Stranded = 1V	4/0 Stranded = 2Q	500 MCM Stranded = 3Q

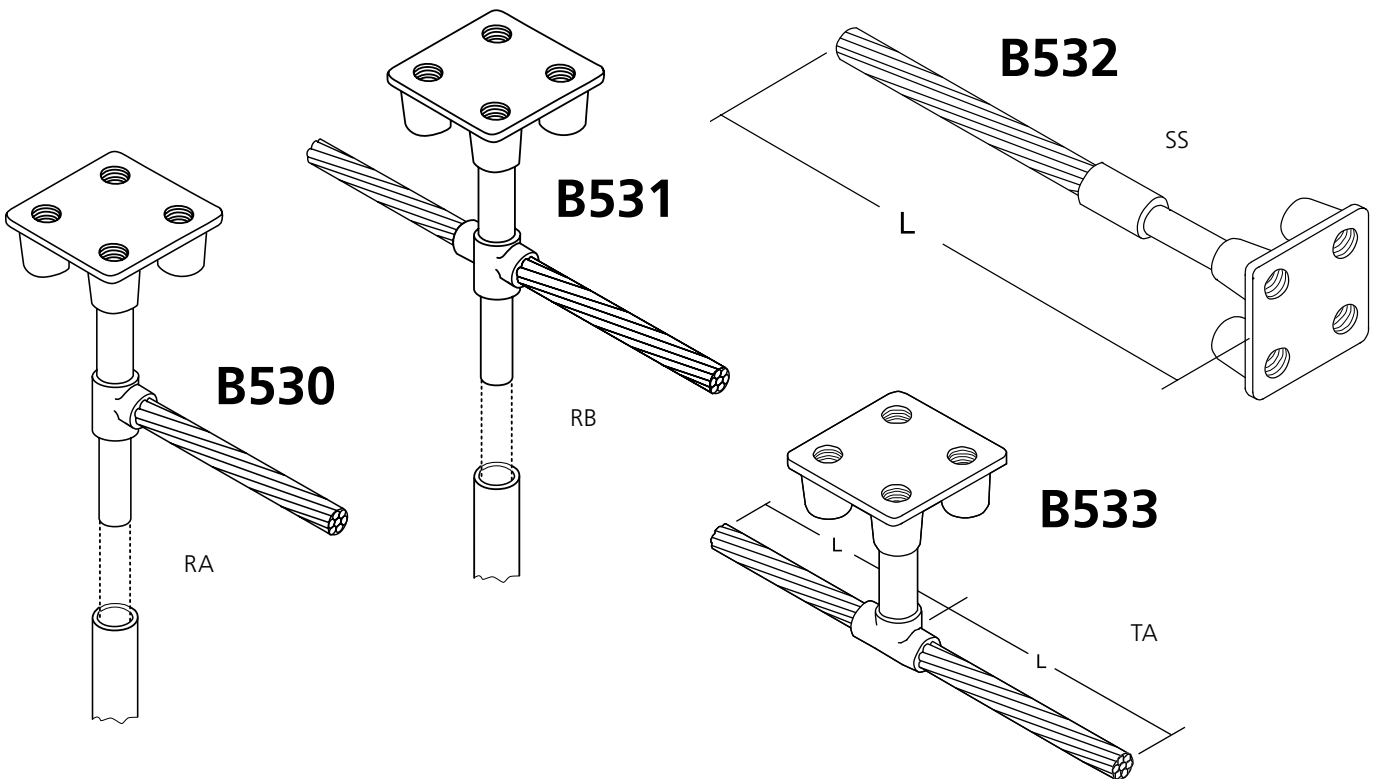

# Aircraft Grounding Receptacles

- Copper alloy castings for use in static grounding systems of aircraft refueling areas
- Easily connected to grounding system conductor and/or ground rods
- Designed for simple installation with flush paved surfaces
- Compatible with CADWELD® connections

## Grounding Receptacles with Ball Stud

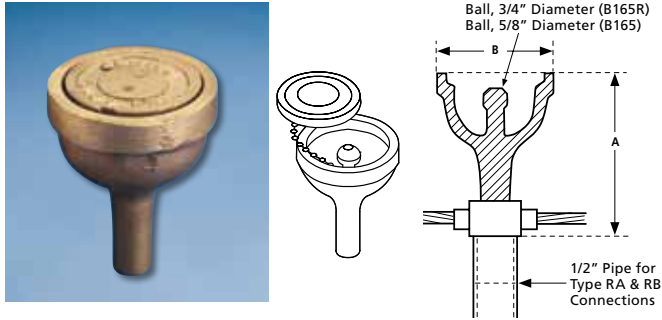

Part No.	Attachment Point	Depth (in) (A)	Diameter (in) at Grade Level (B)	Standard Packaging Quantity
B165*	3/4" Ball Stud	4-1/2	2-3/4	1
B165B	(Cover for B165, included)	—	2-3/4	1
B165R*	Removable 3/4" Ball Stud	4-1/2	2-3/4	1
B165RS*	Removable 3/4" Ball Stud	4-1/2	2-3/4	1

## Grounding Receptacles with Bar Attachment Point

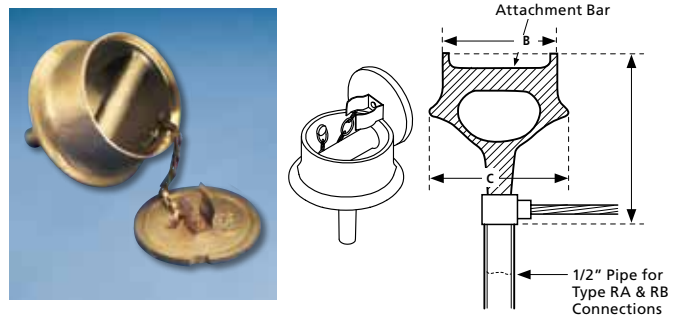

Part No.	Attachment Point	Depth (in) (A)	Diameter (in) at Grade Level (B)	Maximum Diameter (in) (C)	Standard Packaging Quantity
B166*	3/4" Diameter Bar	6-1/4	3-7/8	4-3/4	1
B166B	(Cover for B166, included)	—	3-7/8	—	1
B167	1.5" Diameter Bar	7-1/4	4-3/4	6-1/2	1
B167B	(Cover for B167, included)	—	4-3/4	—	1

\* Aircraft static grounding clamp B2617A can be used to connect to the B165, B165R, and B166.

## Copper-bonded Aircraft Tie Down Rods

Specifications	
663400	Nominal 3/4" diameter x 10' length

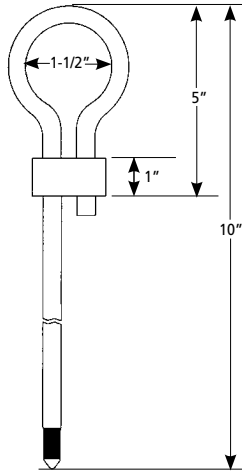

## Depression Mold DM5834

Plastic for making 3" x 6" x 2.5" deep depression in concrete pour around loop in aircraft tie-down.

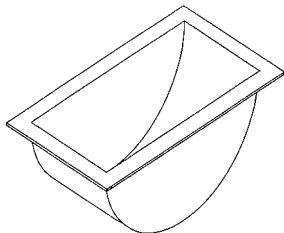

## Grounding Receptacles for Sectional Ground Rods

- Copper alloy castings for use in static grounding systems of aircraft refueling areas
- Easily connected to grounding system conductor and/or ground rods
- Designed for simple installation with flush paved surfaces
- Standard pin connection
- Chain-retained cover plate
- Couple directly to 3/4" sectional or extension rod

Part No.	Standard Packaging Quantity
LPC680	1
LPC681**	1

\*\* Spring clip included to secure cover plate.

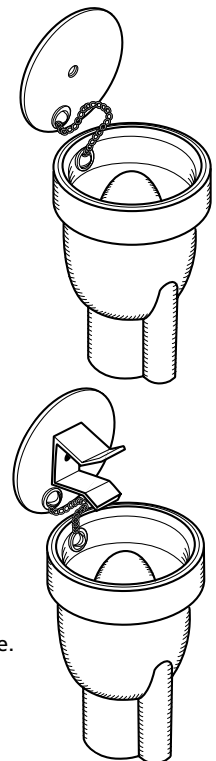



## The importance of SRGs for Computer Applications

In order to minimize the effects of noise, many computer manufacturers, users and government agencies have detailed specifications regarding computer grounding. Computer installations are particularly sensitive to:

- Coupling between adjacent power, data circuits and ground, where noise can be introduced into cables — even nearby lightning strikes can be a real threat.
- Noise levels from nearby transmitters may be a serious problem and require shielding.

## Components of the SRG

### Effective SRG uses:

- A multitude of conductors to create a very low impedance to noise at any frequency
- 2-foot spacing between conductors
- Terminations that provide a constant impedance over the life of the facility
- Multiple paths within the SRG to allow the noise currents to divide at each crossover, which further reduces voltage drop
- A mesh made of flat copper strips to provide the most functional low impedance and cost effective computer grounding system available
- Welded connections to assure a noise-free bond

## Welded Connections

Welded connections are often specified because they are the only connections proven to assure a “noise-free” bond. Normal shock and vibration jar mechanical connections, creating electronic noise. This causes relatively high  $Ldi/dt$  voltages, due to a sudden change in connection impedance. This sudden change can result in pulses which can be coupled onto the signal circuits. These unwanted signals can create false data or even cause permanent circuit damage. Corrosion, dirt and cleaning fluids cannot interfere with the molecular bond of a welded joint.



Pre-fabricated Signal Reference Grid installed under computer room floor.

# Signal Reference Grid (SRG)

The Signal Reference Grid (SRG) is a pre-fabricated, low impedance network of conductors established to create an equipotential plane for high frequency, low voltage digital signals in such applications as intensive computer, telemetry and telecommunications installations.

Digital signal line voltages are typically low. Their sensitivity to transient noise is very high (typically 1 volt for some digital systems). The SRG complies with IEEE® Standard 1100-1992 for grounding practices in sensitive electronic environments.

Proper grounding and bonding of sensitive electronic systems, including computer installations, requires careful consideration of all frequencies from DC to over 100 megahertz. The local requirements for electrical fault current and lightning protection must also be met.

The safety grounding system required by code does not address the special requirements of noise immunity. An additional "grounding" system called the Signal Reference Grid (SRG) is needed for trouble-free equipment performance.

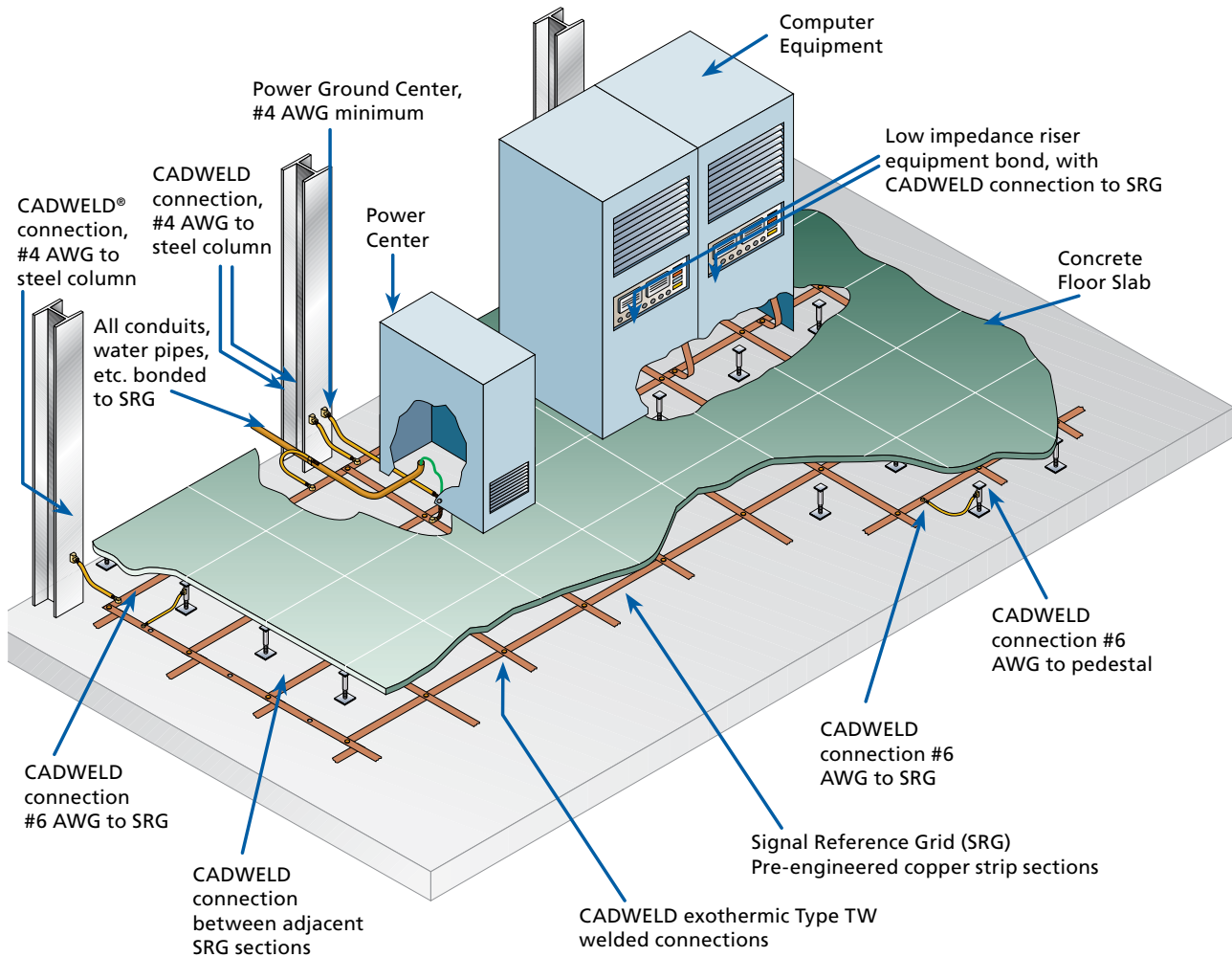

## Important points to consider when installing an SRG:

- Local codes must be followed.
- All equipment shall be bonded to the ERITECH® brand of SRG using low impedance risers. Never connect to strip closest to outside wall.
- All raised floors within the computer room should be bolted stringer type.
- Every sixth raised floor pedestal in each direction shall be connected to the SRG using a #6 AWG concentric copper conductor. The connection to both the pedestal and the SRG shall be a CADWELD exothermic connection.
- All columns, conduits, water pipes, ducts, etc. entering the computer room shall be bonded to the SRG (at each end of the room if these are horizontal).
- Power distribution panels and power distribution center should be mounted directly to the building steel or bonded to it by a short length of grounding conductor equal to the "green wire ground" but at least #4 AWG copper. The grounding wire inside any panel or enclosure supplying AC power to the computer must be bonded to its enclosure.





# Signal Reference Grid (SRG)

## Signal Reference Grids

- Manufactured from 2" wide x 26 gauge (0.0159") copper strips
- Custom sizes available (see part numbering below)

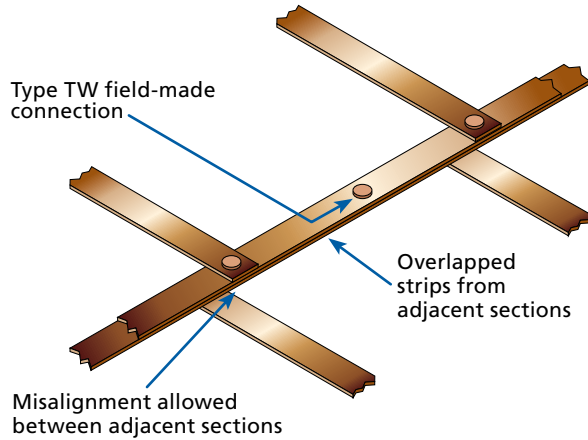
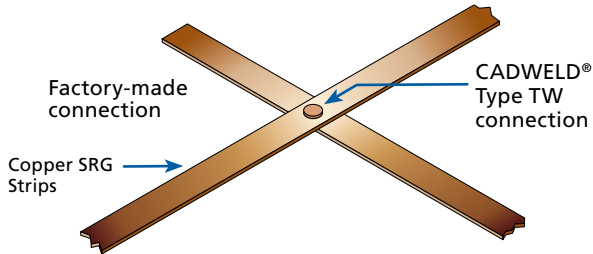

The pre-fabricated Signal Reference Grid sections are constructed with factory-made connections, and then each section is connected on site with type TW field made connections.

## Low Impedance Riser (LIR)

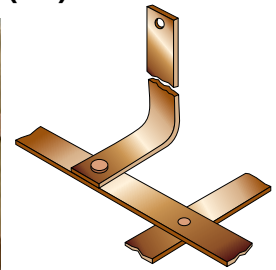

- Welded to the SRG using CADWELD® mold type TW
- 5/16" hole in one end for connecting to equipment (same material as SRG)
- 40,481 circular mils
- 23 ohms impedance for 12" length at 20 MHz

Part No.	Thickness	Width (in)	Length (in)
B802D01A72	26 gauge (0.0159")	2	72

## SRG Part Numbering

### SRG

#### Grid Spacing

B=24"  
C=48"  
F=12"  
G=36"

#### Width

A = 4' E = 12' J = 3'  
B = 6' F = 14' K = 5'  
C = 8' G = 16' L = 7'  
D = 10' H = 2' M = 9'

#### Length in Feet (3 digits)

Part No.	Grid Spacing (in)	Width (ft)	Length (ft)
SRGBD100	24 x 24	10	100
SRGBE100	24 x 24	12	100
SRGBG100	24 x 24	16	100

## How to Specify

The Signal Reference Grid shall be manufactured from 2" wide by 26 gauge (0.0159 inch thick) copper strips on 2', 600 mm or 1200 mm centers. All crossovers shall be joined by welding. The SRG shall be furnished 4' to 16' wide. The sections shall be rolled on tubes with the outside of the roll protected for shipment. These sections shall be bonded to each other in the field with CADWELD® connections.

### Note:

1. Other strip sizes are available
2. Other spacing is available
3. Roll weight usually limited to about 200 lbs. gross weight for convenience (1200 sq. ft.)

# Signal Reference Grid (SRG)

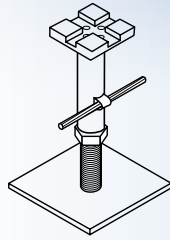

## CADWELD® Standard Connections to Steel Pedestal

Conductor Size (7-Strand)	Pedestal Type	CADWELD Mold Part No.	Welding Material	Handle Frame
#6 AWG	1" round	VTP1H005M	15	B399CS
#6 AWG	7/8" square	VGT1H004M	15	B399AS
#4 AWG	1" round	VTP1L003M	15	B399CS
#4 AWG	7/8" square	VGT1L010M	25	B399AS
#2 AWG	1" round	VTP1V004M	15	B399CS
#2 AWG	7/8" square	VGT1V004M	25	B399AS

## CADWELD® EXOLON Connections to Steel Pedestal

Conductor Size (7-Strand)	Pedestal Type	CADWELD Mold Part No.	Welding Material	Handle Frame
#6 AWG	1" round	XLVTP1H005M	XL15	B399CS
#6 AWG	7/8" square	XLVGP1H004M	XL15	XLB399BS
#4 AWG	1" round	XLVTP1L003M	XL15	XLB399CS
#4 AWG	7/8" square	XLVGP1L010M	XL15	XLB399BS
#2 AWG	1" round	XLVTP1V004M	XL15	XLB399CS
#2 AWG	7/8" square	XLVGP1V004M	XL15	XLB399BS

## CADWELD® Connections to 26 Gauge x 2" SRG

Conductor Size (7-Strand)	Mold Style	Mold Part No.	Welding Material	Handle Clamp
#6	CADWELD EXOLON Standard	XLHAC1H013 HAC1H013	XL25 25	XLL160 L160
#4	CADWELD EXOLON Standard	XLHAC1L020 HAC1L020	XL32 32	XLL160 L160
#2	CADWELD EXOLON Standard	XLHAC1V012 HAC1V012	XL32 32	XLL160 L160

## CADWELD® Type TW Connections



Mold Part No.	Mold Style	Welding Material	Handle Clamp
XLTWR107A3	CADWELD® EXOLON	XL32	XLL160
TWR107A3	Standard	32	L160

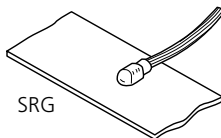

SRG

\*CADWELD EXOLON is a low-emission welding process and is recommended for retrofit jobs. To start the CADWELD EXOLON reaction, the CADWELD EXOLON battery pack is required (part # **XLB971A1**). Welding tray (part # **XLB974B2**) can be used under the mold to protect cables and equipment from hot materials.

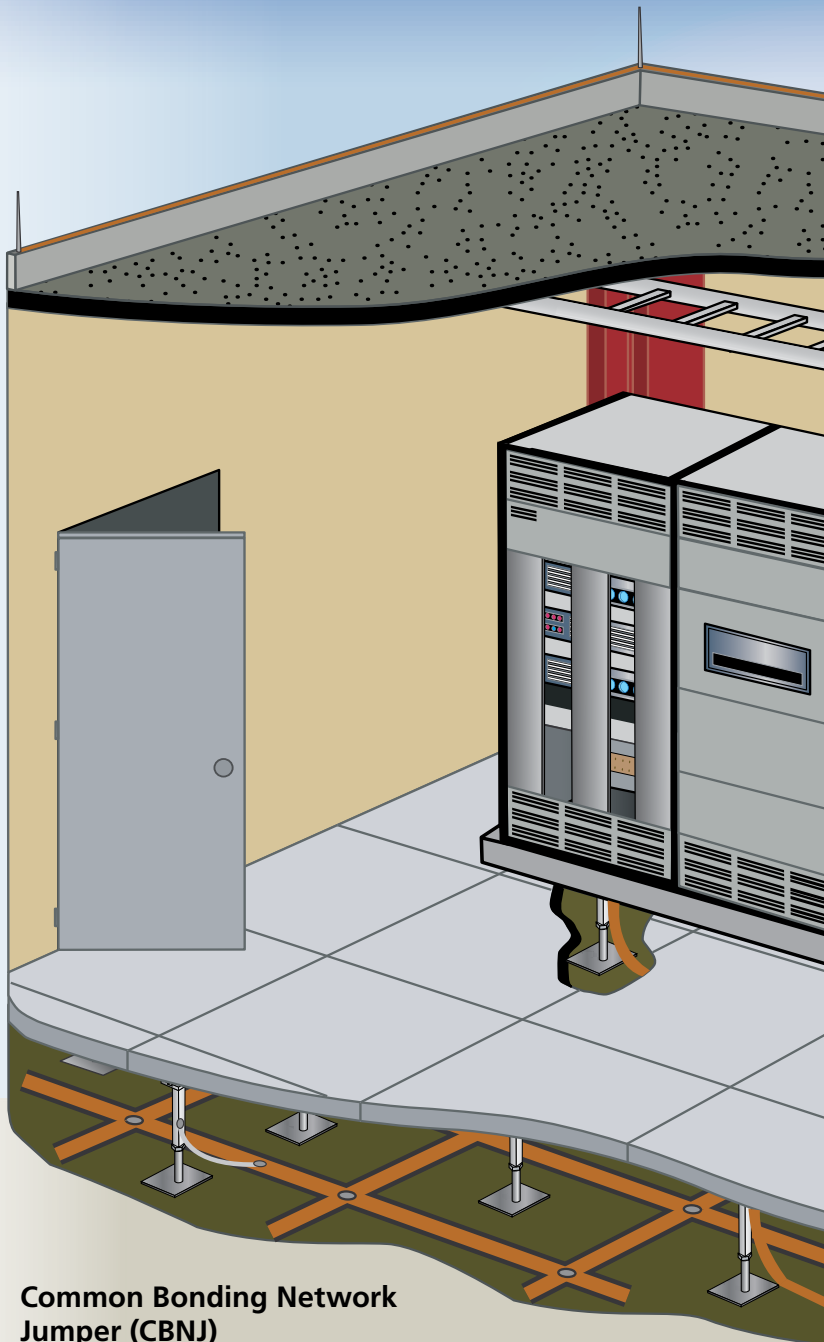

## Common Bonding Network Jumper (CBNJ)



- Helps to achieve a secure electrical connection in telecommunications
- Stranded wire allows for small radius bends
- Tinned copper lug and hardware included

Part No.	Cable Size (AWG)	Cable Length (ft)	Standard Package
CBNJ09	6 Stranded	9	25
CBNJ09P10	6 Stranded	9	50

# Signal Reference Grid (SRG)

## Mesh Bonding Network Connectors

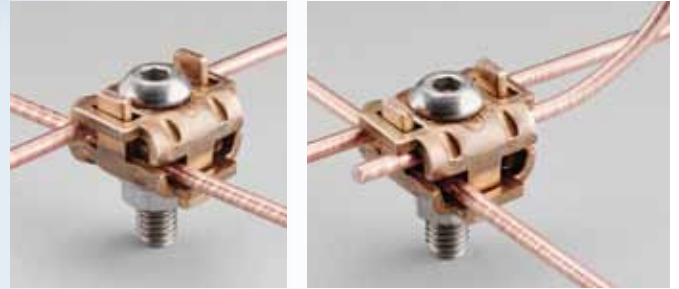

SRGC46

SRGC46



MBNC

- MBNC heavy duty clamps with stainless steel hardware, suitable for direct burial (UL® 467 Listed)
- Allow for fast, simple and economical field connection of grounding and bonding wires
- Can accommodate additional pigtailed that can be used to connect to building steel and equipment
- Can be combined with Universal Pedestal Clamp (part # UPCJ) for bonding to various pedestal sizes for mesh bonding networks (MBN)

Part No.	Conductor Range (AWG)*	Conductor Range (Metric)	Standard Package
MBNC82	8 solid – 2 stranded	10 mm <sup>2</sup> – 35 mm <sup>2</sup>	25

\* Stranded conductors #8 – 2 AWG (10 mm<sup>2</sup> – 35 mm<sup>2</sup>): 7 or 19 strands

## Universal Pedestal Clamp with Cable Management Feature



- Only one attachment required for both mesh bonding and cable management
- Eliminate need for separate mounting brackets for different pedestal types or sizes
- Stainless steel construction of bracket and hardware reduces potential for galvanic corrosion
- Mesh bonding conductors do not have to bend around each pedestal to conform to grid pattern
- UL® Listed as a grounding/bonding clamp in addition to a cable support (Full Code compliance NEC® Article 250 and 300)

Part No.	Conductor Range (AWG)*	Conductor Range (Metric)*	Pedestal Size (Round or Square)	Standard Package
MBNUPCJ82	8 solid – 2 stranded	10 mm <sup>2</sup> – 35 mm <sup>2</sup>	7/8" – 2" (2.2 cm – 5.1 cm)	25

\* Stranded conductors #8 – 2 AWG (10 mm<sup>2</sup> – 35 mm<sup>2</sup>): 7 or 19 strands

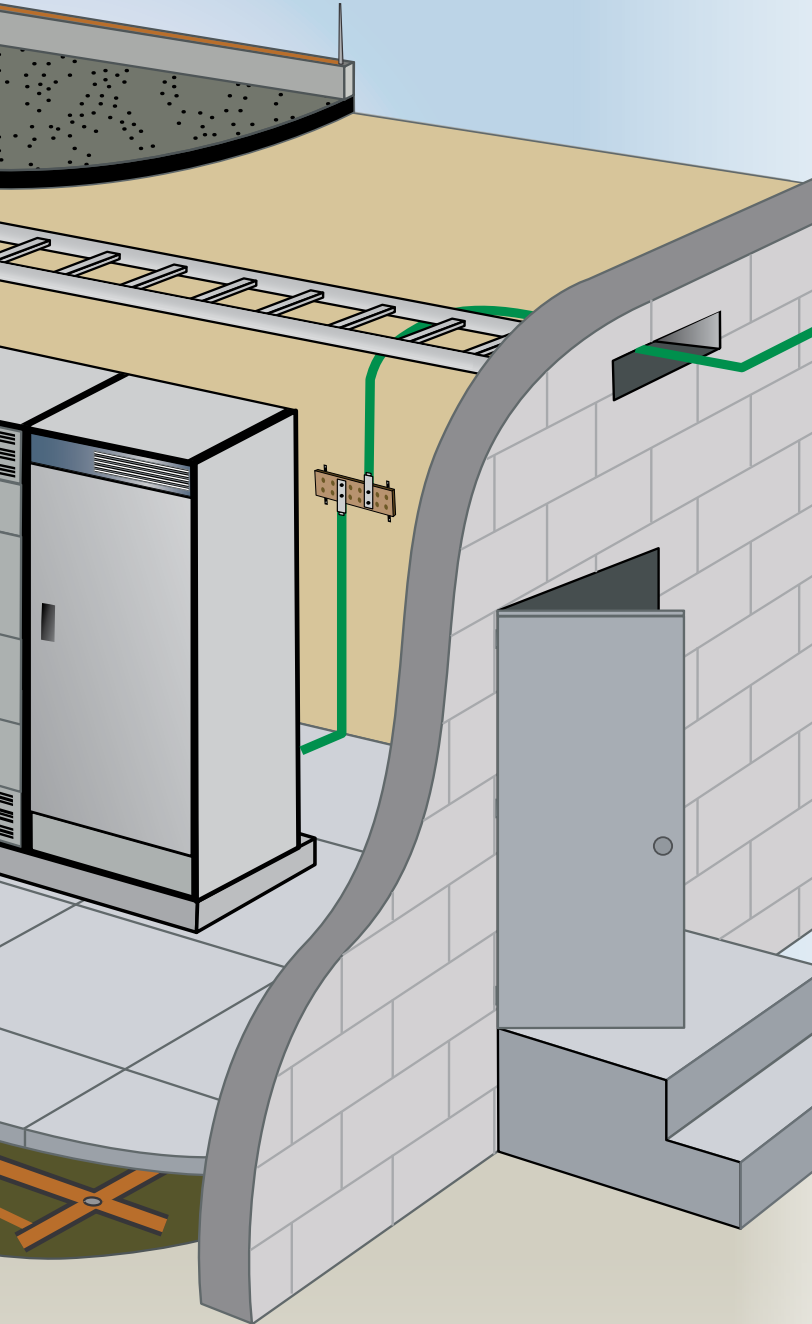

## SRG Clamp & Connector

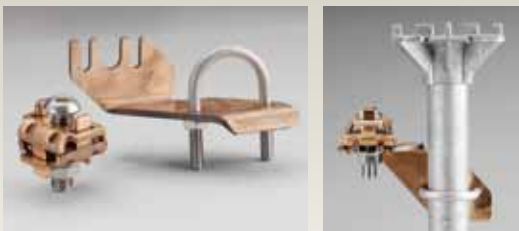

Part No.	Description	Standard Package
SRGC46	SRG Connector for #4 and #6 AWG solid or stranded conductor	20
SRGC46BR	Pedestal mounting bracket for 7/8" square or 1" round pedestals	10

# Equipotential Mesh and Mats

## Prefabricated Wire Mesh

ERITECH® brand of prefabricated wire mesh from ERICO is a convenient, efficient and economical means of improving grounding systems at facilities with high-voltage installations and wherever large area grounds are required. Equipotential mesh reduces step potentials at power plants and substations, and effectively minimizes ground plane fluctuations at communications antenna sites. Wire mesh is also an excellent ground screen, reflector and electronic shield for large facilities.

Personnel safety mats, made of prefabricated wire mesh, are ideal for systems designed to protect operators against "touch potentials" at manually operated disconnect switches.

## Equipotential Mesh Features

- Silver brazed joints provide strength to resist separation during installation and bear the traffic of heavy vehicles
  - Furnished in rolls up to 20' wide
  - 500 lbs. maximum weight
  - Conductor spacing in many rectangular configurations up to 24" x 48" in 2" increments
  - Normally supplied in sections with standard overhang for interconnecting
- ( $\frac{1}{2}$  conductor spacing + 2")

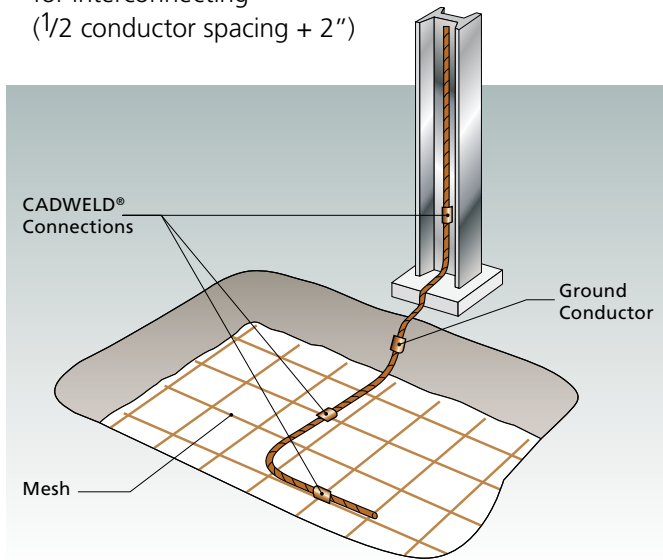

## Available Wire Sizes and Conductivity

Wire Size (AWG)	Material	Conductivity
#6	pure copper	100%
#6	copper-clad steel	30% or 40%
#8	pure copper	100%
#8	copper-clad steel	30% or 40%
#10	pure copper	100%

## Overhang Configurations

M = Conductor Spacing  
L = Total Length  
W = Total Width

### Standard overhang for interconnecting sections of mesh

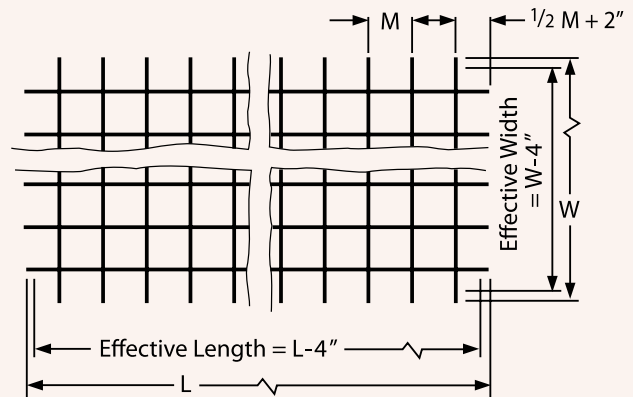

### No overhang

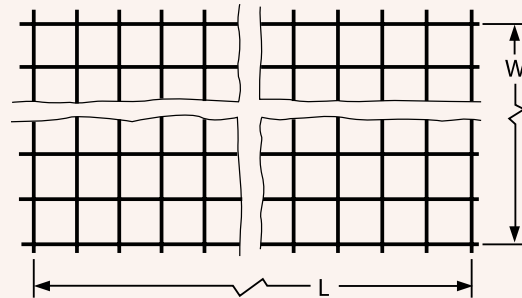

### Half-spacing overhang

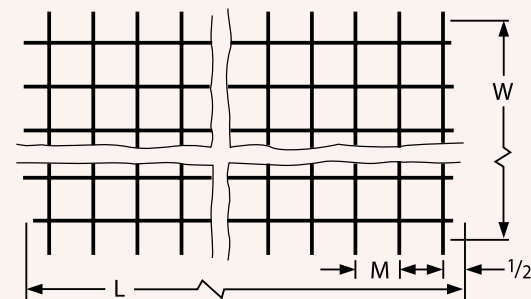

# Equipotential Mesh and Mats

## Easy Installation

- No digging or trenching required
- Unroll over the ground
- Interconnect by welding to adjacent sections of mesh using CADWELD®
- Weld to the main ground grid in substations or welded to ground rods
- May be covered with a layer of earth or crushed stone depending on the application

## Interconnecting

- The CADWELD process provides a rapid and economical method of interconnecting mesh in the field
- Resulting weld is permanent and corrosion resistant
- Current carrying capacity equal to that of the conductor

## Weight of Mesh

### Net Weight (lbs) per 100 Square Feet <sup>Δ</sup>

Conductor Spacing (in)	Copper-clad Steel Wire (AWG)			Solid Copper Wire (AWG)		
	#6	#8	#10	#6	#8	#10
2 x 2	888	558	351	974	609	383
4 x 4	443	279	175	487	305	192
6 x 6	295	186	117	325	203	128
8 x 8	222	139	88	243	153	96
12 x 12	148	93	59	163	102	64
24 x 24	74	47	29	91	51	32
48 x 48	56	35	23	62	38	24

Δ Add 75 lbs per roll for approximate shipping weight.

## Suggested Specifications

Prefabricated wire mesh shall be manufactured using (a)\* AWG bare, solid (b)\* wire on a (c)\* inch x (c)\* inch conductor spacing with all cross connections silver brazed using a 35% silver alloy brazing material and a non-corrosive flux. It shall be (d)\* feet, (d)\* inches wide by (e)\* feet, (e)\* inches long with (f)\* inches overhang on both sides and both ends, and shall be wound on a fiber tube with the outside of the roll protected by wood strips interconnected with steel wire.

- \* (a) Wire size, #6, #8, #10, or #12 AWG.
- (b) 30% or 40% conductivity copper-clad or pure copper.
- (c) 2" x 2" minimum to 48" x 24" maximum (in 2" increments).
- (d) 20', 4" maximum.
- (e) Maximum length determined by weight, with a 500 lbs. maximum net weight.
- (f) No overhang, an overhang equal to one-half conductor spacing or an overhang equal to one-half conductor spacing plus 2" (for interconnecting).



## CADWELD® Connections Joining Adjacent Sections of Wire Mesh or Safety Mats

Solid Wire Sizes (AWG)	CADWELD Mold Part No.*	Welding Material
#6 solid copper	PGT-06CU	25
#6 copper-clad steel	PGT-06CS	15
#8 solid copper	PGT-08CU	15
#8 copper-clad steel	PGT-08CS	15
#10 solid copper	PGT-10CU	15
#10 copper-clad steel	PGT-10CS	15

\* Includes mold handles.

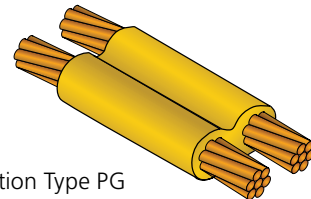

Connection Type PG

## CADWELD Connections of Center Wire to Mesh or Safety Mats

Mat Wire (AWG)	Center Wire Size (AWG)	CADWELD Mold Part No.**	Welding Material
#6 Solid	1/0	PTC1G2C	65
	2/0	PTC1G2G	65
	4/0	PTC1G2Q	90
#8 Solid	1/0	PTC1D2C	65
	2/0	PTC1D2G	65
	4/0	PTC1D2Q	90
#10 Solid	1/0	PTC1A2C	65
	2/0	PTC1A2G	65
	4/0	PTC1A2Q	90

\*\* Molds require L160 handle clamps sold separately.

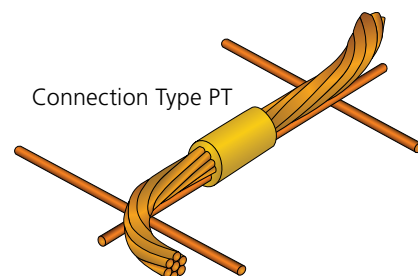

Connection Type PT

# Equipotential Mesh and Mats

## Personnel Safety Mats

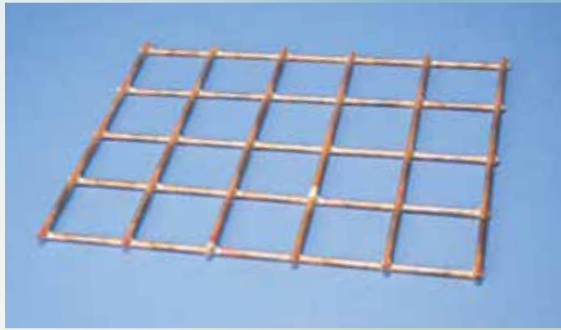

### Available Mat Wire Sizes and Materials

Wire Size (AWG)	Material	Conductivity
#4	pure copper	100%
#6	pure copper	100%
#6	copper-clad steel	30% or 40%
#8	pure copper	100%
#8	copper-clad steel	30% or 40%

Standard Mat Sizes (ft)
4 x 4
4 x 6
6 x 8

Conductor Spacing (in)
2 x 2
4 x 4
6 x 6
8 x 8
12 x 12

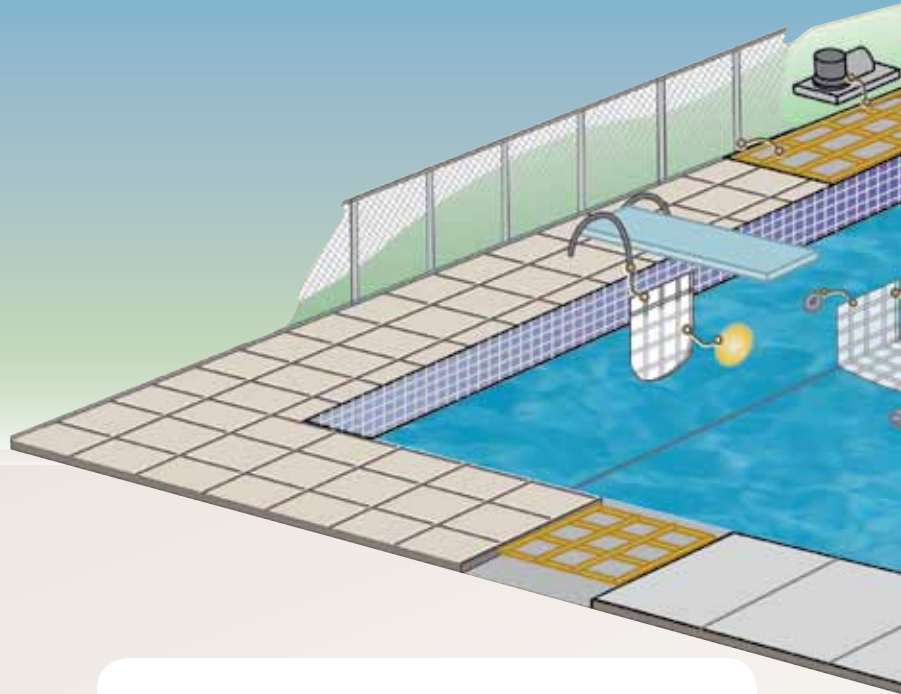

### Standard Configurations

M = Conductor Spacing in Inches  
L = Length in Feet (not including overhang)  
W = Width in Feet

#### Standard Safety Mat

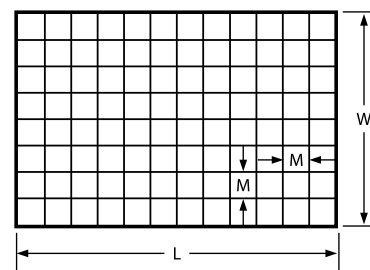

#### Safety Mat with Center Wire\*

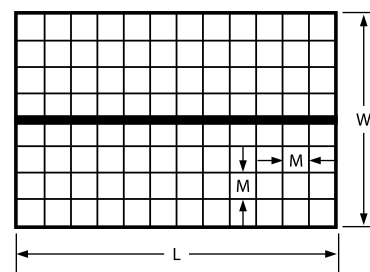

#### Safety Mat with Overhanging Center Wire\*

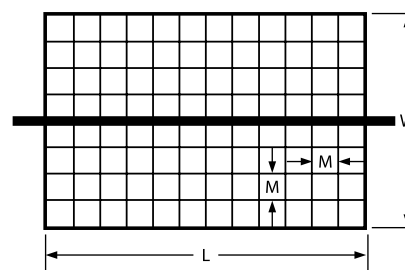

## Suggested Specifications

### Standard Personnel Safety Mats:

Prefabricated personnel safety mats shall be manufactured using (a)\* AWG bare, solid (b)\* wire on (c)\* inches x (c)\* inches conductor spacing. All cross connections shall be silver brazed using a 35% silver brazing alloy and a non-corrosive flux. Overall mat size shall be (d)\* feet x (d)\* feet.

### Mats With Center Wire:

Prefabricated personnel safety mats shall be manufactured using (a)\* AWG bare, solid (b)\* wire on (c)\* inches x (c)\* inches conductor spacing with (e)\* diameter solid copper center wire through the (f)\* length overhanging each end (g)\* inches. All cross connections shall be silver brazed using a 35% silver brazing alloy and a non-corrosive flux. Overall mat size shall be (d)\* feet x (d)\* feet.

- \* (a) #4, #6 or #8 AWG (see chart above).
- (b) 30% or 40% conductivity copper-clad or pure copper (#4 available only in pure copper).
- (c) Minimum of 2 inches, maximum of 12 inches in 2-inch increments (not available in 10-inch increments).
- (d) Standard sizes are 4 feet x 4 feet and 4 feet x 6 feet with maximum 6 feet x 8 feet.
- (e) 5/16 inch (1/0 solid) or 3/8 inch (2/0 solid). Stranded cable is also available (see chart above).
- (f) Longest or shortest.
- (g) Center wire is either flush (0-inch overhang) or with a 6-inch overhang.



# Equipotential Mesh and Mats

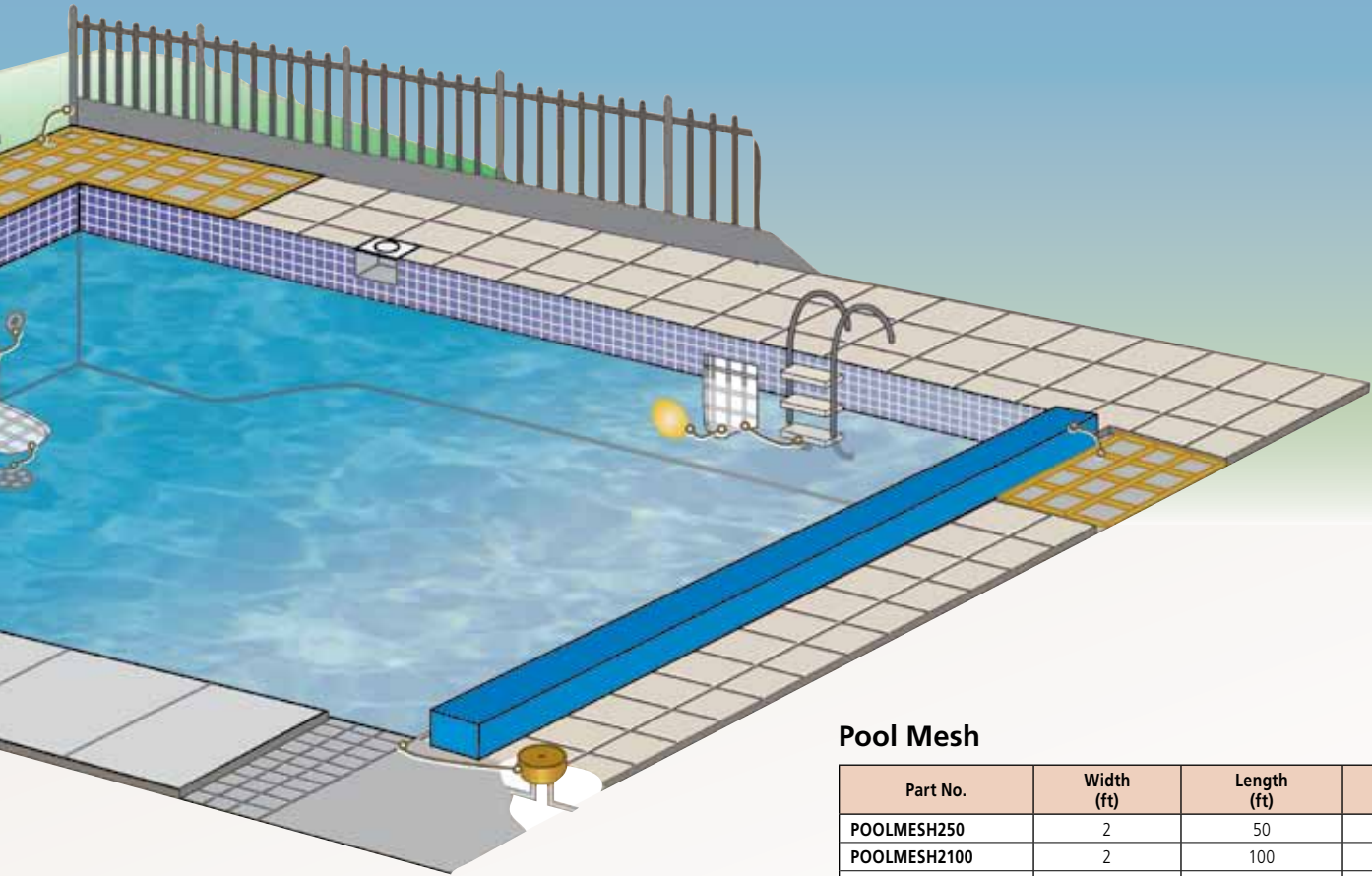

## Pool Mesh

Part No.	Width (ft)	Length (ft)	Conductor (AWG)
POOLMESH250	2	50	8 Solid
POOLMESH2100	2	100	8 Solid
POOLMESH350	3	50	8 Solid
POOLMESH3100	3	100	8 Solid

Wire Size (AWG)
1/0 Solid or Stranded
2/0 Solid or Stranded
4/0 Stranded
250 MCM Stranded
300 MCM Stranded
350 MCM Stranded
500 MCM Stranded

\*Standard Center Wire  
(length-wise or width-wise)

## Expanded Metal Mesh

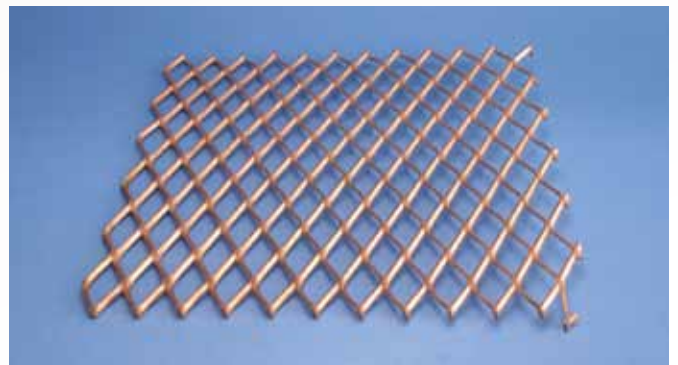

## Net Weight (lbs) per Standard Mat\*

Wire Size	Conductor Spacing (in)									
	2 x 2		4 x 4		6 x 6		8 x 8		12 x 12	
	4 x 4	4 x 6	4 x 4	4 x 6	4 x 4	4 x 6	4 x 4	4 x 6	4 x 4	4 x 6
#6 Copper-clad steel wire	14.6	21.7	7.6	11.2	5.3	7.7	4.1	6.0	2.9	4.2
#8 Copper-clad steel wire	9.2	13.7	4.8	7.1	3.3	4.9	2.6	3.8	1.9	2.7

\* Weights are for copper-clad wire. Add 10% for approximate weight of solid copper wire. Safety mats are palletized for shipment. Add 50 pounds per pallet for gross weight. Maximum of 100 mats per pallet.

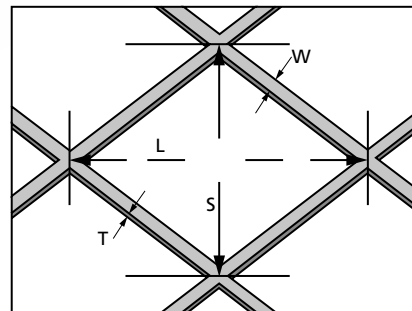

L = Long dimension  
S = Short dimension  
W = Strand width  
T = Thickness

Contact ERICO for more information.

# Bonding Devices

## B21-Series Prefabricated Lug Bonds

Prefabricated lug bonds are custom made to specifications. Common usage includes cable tray bonding and grounding, structure bonds, surge arrester leads and power jumpers.

- Made with bare annealed copper cable
- Tinned copper NEMA® lugs welded to the cable with CADWELD® connections

### Part Number Coding

**B21 2 1L "X"**

B-21 Lug Bond Assembly

Cable Code

Bond Length in inches  
(from outer-most hole center)

#4 Stranded = 1L    1/0 Stranded = 2C  
 #2 Stranded = 1V    2/0 Stranded = 2G  
 #1 Stranded = 1Y    4/0 Stranded = 2Q  
 250 MCM Stranded = 2V

### Lug Configuration

Double-Lug Bond, 1-Hole each on Straight Lugs = "2" (see image A)  
 Double-Lug Bond, 2-Holes each on Straight Lugs = "3" (see image B)  
 Double-Lug Bond, 1-Hole each on 45° Lugs = "4" (see image C)  
 Double-Lug Bond, 2-Holes each on 45° Lugs = "5" (see image D)  
 Single-Lug Bond Stub, 1-Hole on Straight Lug = "6" (see image E)  
 Single-Lug Bond Stub, 2-Holes on Straight Lug = "7" (see image F)  
 Single-Lug Bond Stub, 1-Hole on 45° Lug = "8" (see image G)  
 Single-Lug Bond Stub, 2-Holes on 45° Lug = "9" (see image H)

Double-Lug Bond with 1-Hole NEMA Lugs (Straight)

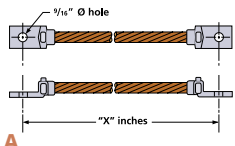

Double-Lug Bond with 2-Hole NEMA Lugs (Straight)

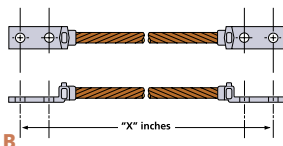

Double-Lug Bond with 1-Hole NEMA Lugs (45° Angle)

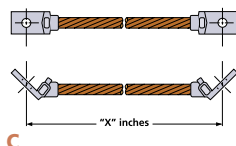

Double-Lug Bond with 2-Hole NEMA Lugs (45° Angle)

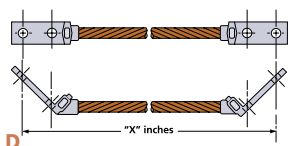

### Double-Lug Bond Part No.\*

Cable Size (AWG)	Stranding	Lug Size (in)	B212-parts One Hole	B213-parts Two Hole	B214-parts One Hole 45°	B215-parts Two Hole 45°
#4	7-strand	1/8 x 1	B2121L -"X"	B2131L -"X"	B2141L -"X"	B2151L -"X"
#2	7-strand	1/8 x 1	B2121V -"X"	B2131V -"X"	B2141V -"X"	B2151V -"X"
#1	7-strand	1/8 x 1	B2121Y -"X"	B2131Y -"X"	B2141Y -"X"	B2151Y -"X"
1/0	7-strand	1/8 x 1	B2122C -"X"	B2132C -"X"	B2142C -"X"	B2152C -"X"
2/0	7-strand	1/8 x 1	B2122G -"X"	B2132G -"X"	B2142G -"X"	B2152G -"X"
4/0	7-strand	3/16 x 1	B2122Q -"X"	B2132Q -"X"	B2142Q -"X"	B2152Q -"X"
250 MCM	19-strand	3/16 x 1	B2122V -"X"	B2132V -"X"	B2142V -"X"	B2152V -"X"

\* "X" indicates total bond length in inches.

Single-Lug Bond Stub with 1-Hole NEMA Lug (Straight)

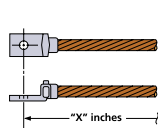

Single-Lug Bond Stub with 2-Hole NEMA Lug (Straight)

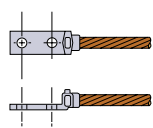

Single-Lug Bond Stub with 1-Hole NEMA Lug (45° Angle)

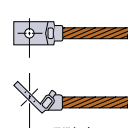

Single-Lug Bond Stub with 2-Hole NEMA Lug (45° Angle)

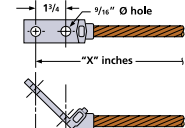

### Single-Lug Bond Stub Part No.\*

Cable Size (AWG)	Stranding	Lug Size (in)	B216-parts One Hole	B217-parts Two Hole	B218-parts One Hole 45°	B219-parts Two Hole 45°
4	7-strand	1/8 x 1	B2161L -"X"	B2171L -"X"	B2181L -"X"	B2191L -"X"
2	7-strand	1/8 x 1	B2161V -"X"	B2171V -"X"	B2181V -"X"	B2191V -"X"
1	7-strand	1/8 x 1	B2161Y -"X"	B2171Y -"X"	B2181Y -"X"	B2191Y -"X"
1/0	7-strand	1/8 x 1	B2162C -"X"	B2172C -"X"	B2182C -"X"	B2192C -"X"
2/0	7-strand	1/8 x 1	B2162G -"X"	B2172G -"X"	B2182G -"X"	B2192G -"X"
4/0	7-strand	3/16 x 1	B2162Q -"X"	B2172Q -"X"	B2182Q -"X"	B2192Q -"X"
250 MCM	19-strand	3/16 x 1	B2162V -"X"	B2172V -"X"	B2182V -"X"	B2192V -"X"

\* "X" indicates total bond length in inches.





## Arc Weldable Bonds

Arc weldable bonds are 4-ft pieces of concentric cable (19-strand) which are flash-welded to steel rod for a bonding connection to structural steel and to rebar. Arc weldable bonds are an economical alternative to exothermic welding when only a few connections need to be made and an arc welder is available on site. The rod is sized to match the ampacity of the cable for fault currents. Complete instructions are provided.

Part No.	Cable Size (AWG)	Cable Length (ft)	Steel Rod Diameter (in)	Steel Rod Length (ft)
EWB2G9164	2/0 Stranded	4	9/16	8
EWB2L584	3/0 Stranded	4	5/8	8
EWB2Q344	4/0 Stranded	4	3/4	8

All cable is 19 strand concentric.

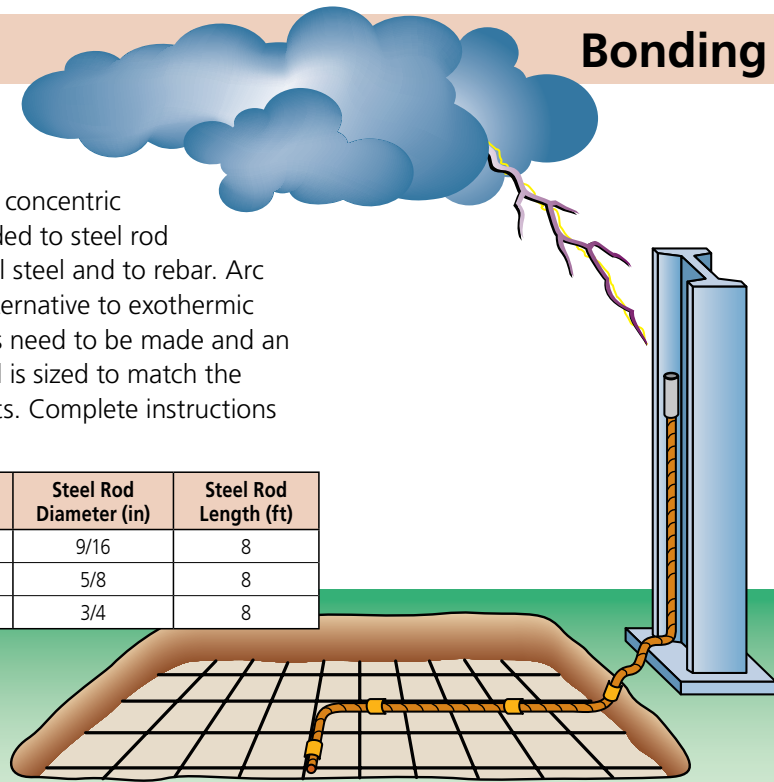

### Welding to Rebar

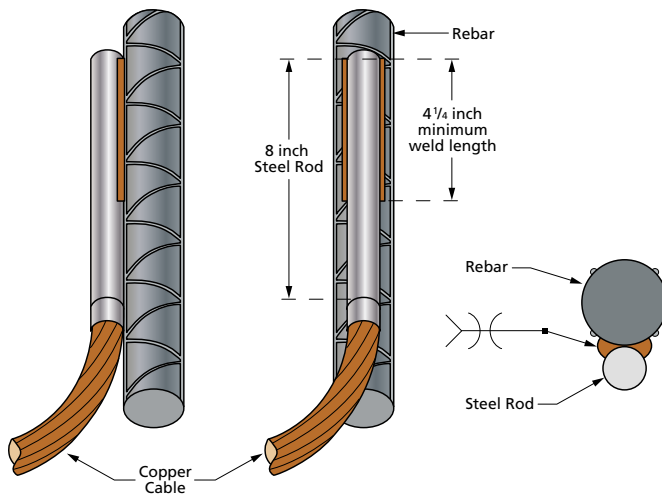

### Welding to Building Steel

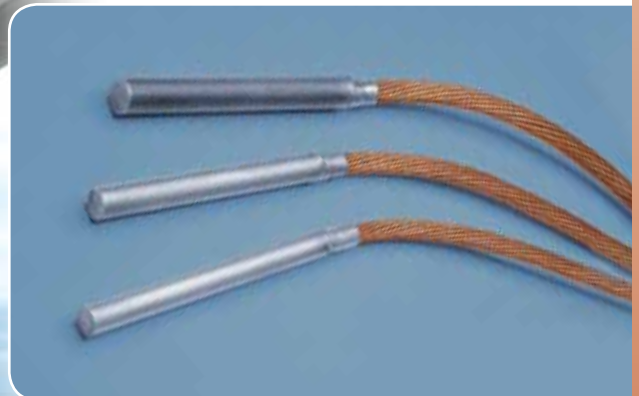
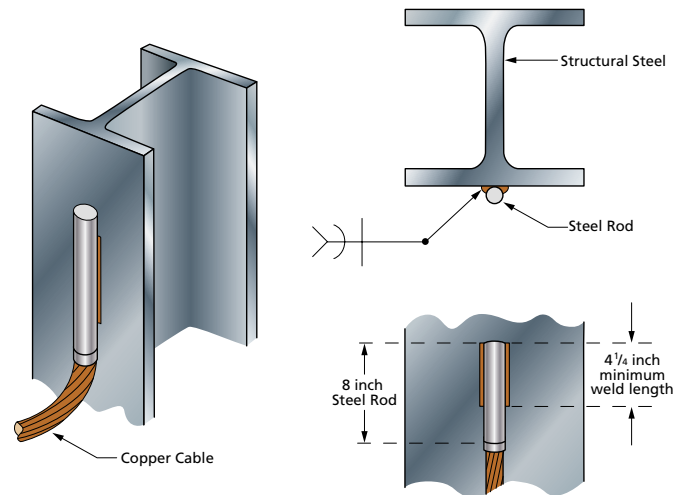

# Copper Bonding Straps



- Tinned electrolytic copper 0.15 mm wire
- UL® 467 File E220029
- Allows bend very close to the contact
- Area working temperature up to 105° C

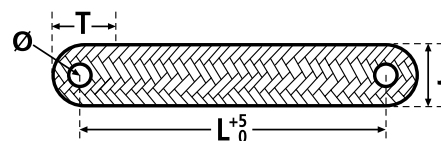

## Earth Braids With Integral Palms

Flexible copper bonding straps (or Earth Braids) have one lug hole at each end, and are tinned for bimetallic use. Extra flexible construction for use on hinged or sliding door bond and on vibrating machinery bond. Lug holes for 1/4" diameter bolt.

- Higher electrical contact
- Resistance to vibration and fatigue
- Excellent tensile strength
- Recommended for EMI protection

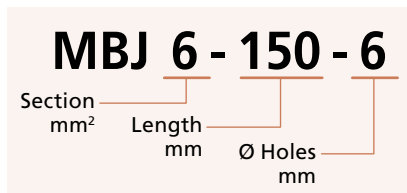

## Comparison of Tensile Strength

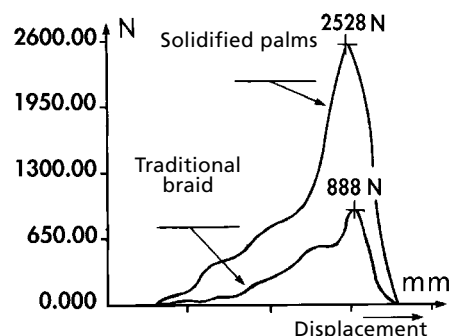

## MBJ-Series

Part No.	Description	Ampacity A	Thick. mm	Section mm²	L mm	Ø mm	J mm	T mm	Box	Weight
556600	MBJ 6-150-6	40	1.1	6	150	6.5	13	23	10	0.010
563410	MBJ 6-200-6	40	1.1	6	200	6.5	13	23	10	0.0167
556930	MBJ 10-200-6	75	1.1	10	200	6.5	12	22	10	0.022
556610	MBJ 10-300-6	75	1.1	10	300	6.5	12	22	10	0.033
563540	MBJ 16-100-6	120	1.5	16	100	6.5	15	25	10	0.018
556620	MBJ 16-100-8	120	1.5	16	100	8.5	15	25	10	0.018
563550	MBJ 16-150-6	120	1.5	16	150	6.5	15	25	10	0.035
556630	MBJ 16-150-8	120	1.5	16	150	8.5	15	25	10	0.035
563300	MBJ 16-200-6	120	1.5	16	200	6.5	15	25	10	0.033
556640	MBJ 16-200-8	120	1.5	16	200	8.5	15	25	10	0.033
556650	MBJ 16-250-8	120	1.5	16	250	8.5	15	25	10	0.040
563320	MBJ 16-300-6	120	1.5	16	300	6.5	15	25	10	0.050
556660	MBJ 16-300-8	120	1.5	16	300	8.5	15	25	10	0.050
556940	MBJ 16-500-8	120	1.5	16	500	8.5	15	25	10	0.082
556670	MBJ 25-100-10	150	1.5	25	100	10.5	23	33	10	0.027
556680	MBJ 25-150-10	150	1.5	25	150	10.5	23	33	10	0.039
563340	MBJ 25-200-6	150	1.5	25	200	6.5	23	33	10	0.052
556690	MBJ 25-200-10	150	1.5	25	200	10.5	23	33	10	0.052
563430	MBJ 25-200-12	150	1.5	25	200	12.5	23	33	10	0.052
556700	MBJ 25-250-10	150	1.5	25	250	10.5	23	33	10	0.064
556710	MBJ 25-300-10	150	1.5	25	300	10.5	23	33	10	0.077
556950	MBJ 25-500-10	150	1.5	25	500	10.5	23	33	10	0.113
556720	MBJ 30-100-10	180	2	30	100	10.5	23	33	10	0.032
556730	MBJ 30-150-10	180	2	30	150	10.5	23	33	10	0.047
556740	MBJ 30-200-10	180	2	30	200	10.5	23	33	10	0.062
556750	MBJ 30-250-10	180	2	30	250	10.5	23	33	10	0.075
556760	MBJ 30-300-10	180	2	30	300	10.5	23	33	10	0.092
556960	MBJ 30-500-10	180	2	30	500	10.5	23	33	10	0.155

Part No.	Description	Ampacity A	Thick. mm	Section mm²	L mm	Ø mm	J mm	T mm	Box	Weight
556770	MBJ 35-100-10	197	2.1	35	100	10.5	23	33	10	0.037
556780	MBJ 35-150-10	197	2.1	35	150	10.5	23	33	10	0.054
556790	MBJ 35-200-10	197	2.1	35	200	10.5	23	33	10	0.072
556800	MBJ 35-250-10	197	2.1	35	250	10.5	23	33	10	0.089
565000	MBJ 35-250-25	197	2.1	35	250	25.5	40	50	10	0.089
556810	MBJ 35-300-10	197	2.1	35	300	10.5	23	33	10	0.110
556970	MBJ 35-500-10	197	2.1	35	500	10.5	23	33	10	0.180
556820	MBJ 50-100-10	250	2.5	50	100	10.5	28	38	10	0.052
556830	MBJ 50-150-10	250	2.5	50	150	10.5	28	38	10	0.077
563350	MBJ 50-200-6	250	2.5	50	200	6.5	28	38	10	0.120
556840	MBJ 50-200-10	250	2.5	50	200	10.5	28	38	10	0.120
563440	MBJ 50-200-12	250	2.5	50	200	12.5	28	38	10	0.120
563360	MBJ 50-200-16	250	2.5	50	200	16.5	28	38	10	0.110
563370	MBJ 50-200-18	250	2.5	50	200	18.5	28	38	10	0.110
556850	MBJ 50-250-10	250	2.5	50	250	10.5	28	38	10	0.127
563380	MBJ 50-300-6	250	2.5	50	300	6.5	28	38	10	0.150
556860	MBJ 50-300-10	250	2.5	50	300	10.5	28	38	10	0.153
563390	MBJ 50-300-16	250	2.5	50	300	16.5	28	38	10	0.150
563400	MBJ 50-300-18	250	2.5	50	300	18.5	28	38	10	0.140
556980	MBJ 50-500-10	250	2.5	50	500	10.5	28	38	10	0.255
563560	MBJ 50-500-12	250	2.5	50	500	12.5	28	38	10	0.255
563450	MBJ 70-300-6	290	5	70	300	6.5	28	38	10	0.210
563460	MBJ 70-300-10	290	5	70	300	10.5	28	38	10	0.210
563420	MBJ 70-300-12	290	5	70	300	12.5	28	38	10	0.210
563470	MBJ 70-300-16	290	5	70	300	16.5	28	38	10	0.200
563480	MBJ 70-300-22	290	3.5	70	300	22.5	40	50	10	0.200
563490	MBJ 70-500-10	290	5	70	500	10.5	28	38	10	0.340
563500	MBJ 100-250-16	349	4	100	250	16.5	50	60	10	0.254
563510	MBJ 100-250-30	349	4	100	250	30.5	50	60	10	0.254
563520	MBJ 100-500-16	349	4	100	500	16.5	50	60	10	0.508
563530	MBJ 100-500-30	349	4	100	500	30.5	50	60	10	0.508



COPPER BONDING STRAPS

## Contact Kits

- Metal nuts, bolts and washers for good electrical contact
- 100 nuts – 100 bolts
- 200 flat washers
- 200 contact washers (SAE® Grade 5 hardware)

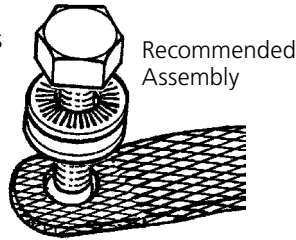

Part No.	Description	Torque (ft/lbs)	
561400	Contact Kit 1/4 – 20 x 5/8"	9	100
561401	Contact Kit 5/16 – 18 x 1-1/4"	18	100
561402	Contact Kit 7/16 – 14 x 1-1/4"	50	100
561403	Contact Kit 7/16 – 14 x 2"	50	100
561404	Contact Kit 1/2 – 13 x 1-1/4"	75	100
561405	Contact Kit 1/2 – 13 x 1-1/2"	75	100
561406	Contact Kit 1/2 – 13 x 2"	75	100

## Cable Runway Ground Strap (CRGS)



- Bonds cable tray, wire mesh tray and cable runway components to the telecommunications grounding and bonding infrastructure
- Offers a better electrical connection than wires with lugs

Part No.	Braid Cross Sectional Equivalent	Cable Length (in)	Standard Package
CRGS6	6 Stranded	8	50



\* Hardware pack (part no. CRGA6HW sold separately).

Part No.	Description	Screw Size	Standard Package
CRGS6HW	Hardware Pack for CRGS6	#12 - 24	50



Round braids with crimped lugs

## BJ-Series

Part No.	Description	Section mm <sup>2</sup>	L mm	Ø D mm	Intensity A		
556900	BJ 6-150 S	6	150	6.5	45	10	0.010
556910	BJ 6-200 S	6	200	6.5	45	10	0.015
556920	BJ 10-300 S	10	300	6.5	75	10	0.033

## Custom Solutions (Made-to-order)

ERICO can provide made-to-order, custom configurations to your drawing specifications.

ERIFLEX® brand of copper braids can be made to custom lengths, widths, thicknesses and hole patterns; with PVC insulation; in flat or tubular shapes; using copper wire; in continuous coils; or with soldered studs or crimped lugs. Let ERICO solve your design and production scheduling challenges.



## MTO Braid Check List:

### \*Braid:

Bare Copper \_\_\_\_\_  
 Tinned Copper \_\_\_\_\_  
 Stainless Steel \_\_\_\_\_

### \*Contact:

Bare Copper \_\_\_\_\_  
 Nickel Plated \_\_\_\_\_  
 Silver Plated \_\_\_\_\_  
 Tinned Copper \_\_\_\_\_

### Design:

\*OAL (Overall Length) \_\_\_\_\_  
 Number of Rows \_\_\_\_\_  
 Number of Layers \_\_\_\_\_  
 \*Pad # 1 L \_\_\_\_\_ x W \_\_\_\_\_ x T \_\_\_\_\_  
 \*Pad #1 Number of holes \_\_\_\_\_  
 \*Pad # 2 L \_\_\_\_\_ x W \_\_\_\_\_ x T \_\_\_\_\_  
 \*Pad #2 Number of holes \_\_\_\_\_  
 \*Estimated cross section \_\_\_\_\_sq.mm

\* Must have

# Fence Clamp Assemblies

## Flexible Jumpers for Fence and Gate Grounding

Made from welding cable, flexible jumpers provide both conductor flexibility and strand protection, and are used to bond gates, switch operating handles and any other item where movement or vibration requires a flexible grounding jumper.

The connections are made with CADWELD® exothermic connections using the same mold required for other fence post connections.



### Part Number Coding

Example: **FJ 2Q 24**

Flexible Jumper      Cable Code      Length of Jumper (inches)

#2 Solid = 1T  
2/0 Stranded = 2G  
4/0 Stranded = 2Q

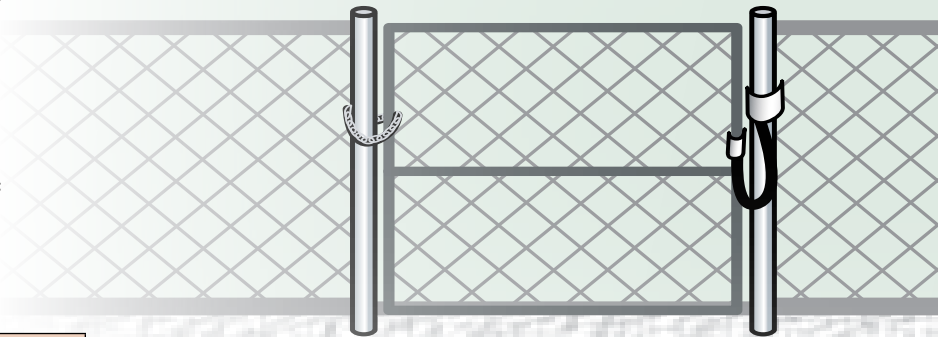
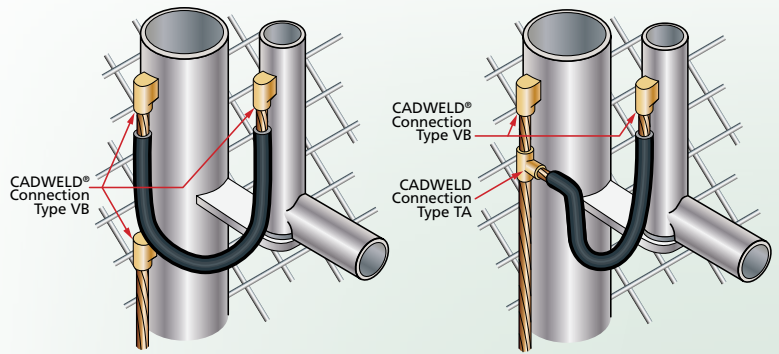

Part No.	Cable Code	Cable Size (AWG)	Length (in)
FJ1T18	1T	#2 Stranded	18
FJ1T24	1T	#2 Stranded	24
FJ1T96	1T	#2 Stranded	96
FJ2G12	2G	2/0 Stranded	12
FJ2G16	2G	2/0 Stranded	16
FJ2G18	2G	2/0 Stranded	18
FJ2G24	2G	2/0 Stranded	24
FJ2G36	2G	2/0 Stranded	36
FJ2G48	2G	2/0 Stranded	48
FJ2G72	2G	2/0 Stranded	72
FJ2G84	2G	2/0 Stranded	84
FJ2G96	2G	2/0 Stranded	96
FJ2G120	2G	2/0 Stranded	120
FJ2G144	2G	2/0 Stranded	144
FJ2G156	2G	2/0 Stranded	156
FJ2G192	2G	2/0 Stranded	192
FJ2G240	2G	2/0 Stranded	240
FJ2G300	2G	2/0 Stranded	300
FJ2G360	2G	2/0 Stranded	360
FJ2Q12	2Q	4/0 Stranded	12
FJ2Q16	2Q	4/0 Stranded	16
FJ2Q18	2Q	4/0 Stranded	18
FJ2Q24	2Q	4/0 Stranded	24
FJ2Q36	2Q	4/0 Stranded	36
FJ2Q48	2Q	4/0 Stranded	48
FJ2Q60	2Q	4/0 Stranded	60
FJ2Q96	2Q	4/0 Stranded	96
FJ2Q120	2Q	4/0 Stranded	120
FJ2Q144	2Q	4/0 Stranded	144
FJ2Q156	2Q	4/0 Stranded	156
FJ2Q180	2Q	4/0 Stranded	180
FJ2Q192	2Q	4/0 Stranded	192
FJ2Q240	2Q	4/0 Stranded	240
FJ2Q252	2Q	4/0 Stranded	252

Conductor Size (AWG)	Pipe Size (in)	CADWELD Mold Part No.	Welding Material Size
2/0	*	VBC2G008V*	90
4/0	1-1/4 - 3-1/2	VBC2G009	90
	*	VBC2Q006V*	115
	1-1/4 - 3-1/2	VBC-2Q-003	115

\* Made to exact pipe size. Add nominal pipe size mold to part number.



### Example for CADWELD® Mold Part Numbering:

1. A 4" outside-diameter pipe is a 3 1/2" nominal pipe size. The mold part number for a 4/0 concentric conductor to this pipe would be:

**VSC2Q V 3.50**

Base number (for flat surface)      For vertical pipe      3 1/2" nominal pipe size

2. A nominal 2 x 2 1/4" H section uses mold code PH2. A 4/0 Type VB weld to this post would be VBC2QPH2.



# Fence Clamp Assemblies

## Fence & Gate Clamp Assemblies



- Ideal for when CADWELD® connections cannot be made to aluminum pipe or thin-wall steel tube
- Made of tinned, electrolytic copper
- Stainless steel hardware
- Available for field-welding or with pre-fabricated cable and ground leads

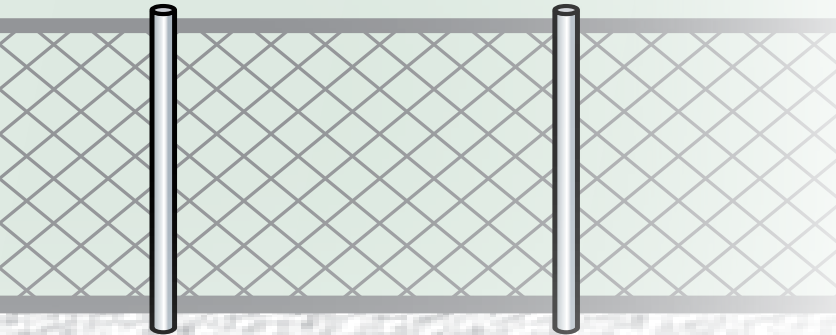

## B522 Fence Clamps for Field-Welded Connections

Part No.	Nominal Pipe Size (in)
B522B	1-1/4
B522C	1-1/2
B522D	2
B522E	2-1/2
B522F	3
B522G	3-1/2
B522H	4
B522K	6

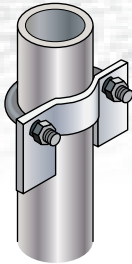

Cable Size (AWG)	CADWELD® Mold Part No.	Welding Material
1/0	LAC2C002	65
2/0	LAC2G002	65
4/0	LAC2Q002	90



## A235 Pre-fabricated Fence Clamp Assemblies with Single Ground Lead

### Part Number Coding

Example: **A235 B 2C 3 LH**

**A235** Nominal pipe size (inches)  
 B = 1-1/4" F = 3"  
 C = 1-1/2" G = 3-1/2"  
 D = 2" H = 4"  
 E = 2-1/2"

**B** Cable Code (AWG)  
 2C = 1/0 Stranded  
 2G = 2/0 Stranded  
 2Q = 4/0 Stranded

**2C** Cable Code (AWG)

**3** Ground Lead Length (feet)

**LH** Left Hand (LH) or Right Hand (RH)

Part No.	Nominal Pipe Size (in)	Cable Size (AWG)	Ground Lead Length (ft)
A235B2C3LH	1-1/4	1/0 Stranded	3
A235C2C1LH	1-1/2	1/0 Stranded	1
A235C2C1RH	1-1/2	1/0 Stranded	1
A235C2G2LH	1-1/2	2/0 Stranded	2
A235D2C1RH	2	1/0 Stranded	1
A235D2G2LH	2	2/0 Stranded	2
A235D2Q4RH	2	4/0 Stranded	4
A235E2C3RH	2-1/2	1/0 Stranded	3
A235E2G4LH	2-1/2	2/0 Stranded	4
A235E2Q2RH	2-1/2	4/0 Stranded	2
A235F2G2LH	3	2/0 Stranded	2
A235F2Q10RH	3	4/0 Stranded	10
A235F2Q5RH	3	4/0 Stranded	5
A235G2Q2RH	3-1/2	4/0 Stranded	2
A235G2Q4RH	3-1/2	4/0 Stranded	4
A235H2C4RH	4	1/0 Stranded	4
A235H2Q2LH	4	4/0 Stranded	2
A235H2Q2RH	4	4/0 Stranded	2

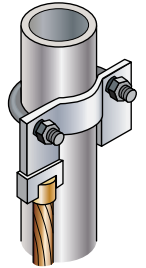

Left hand shown

## A237 Pre-fabricated Fence Clamp Assemblies with Double Ground Leads

### Part Number Coding

Example: **A237 C 2Q 8**

**A237** Nominal pipe size (inches)  
 B = 1-1/4" F = 3"  
 C = 1-1/2" G = 3-1/2"  
 D = 2" H = 4"  
 E = 2-1/2"

**C** Cable Code (AWG)  
 2C = 1/0 Stranded  
 2G = 2/0 Stranded  
 2Q = 4/0 Stranded

**2Q** Cable Code (AWG)

**8** Length of each Ground Lead (feet)

Part No.	Nominal Pipe Size (in)	Cable Size (AWG)	Length of Each Ground Lead (ft)
A237C2Q8	1-1/2	4/0 Stranded	8
A237D2G1	2	2/0 Stranded	1
A237D2G2	2	2/0 Stranded	2
A237D2Q4	2	4/0 Stranded	4
A237E2Q1	2-1/2	4/0 Stranded	1
A237E2Q4	2-1/2	4/0 Stranded	4
A237F2C6	3	1/0 Stranded	6
A237F2Q4	3	4/0 Stranded	4
A237H2C1	4	1/0 Stranded	1
A237H2C4	4	1/0 Stranded	4
A237H2Q4	4	4/0 Stranded	4

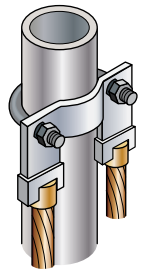

# Fence Clamp Assemblies

## A238 Pre-fabricated Gate Jumper Assemblies

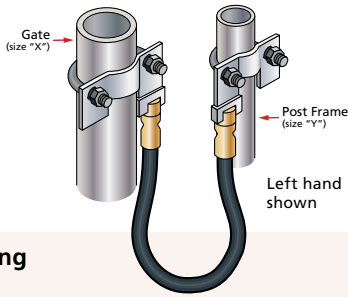

### Part Number Coding

Example:

**A238 "XY" 2S 12 LH**

Nominal Gate Size (in) "X"	Nominal Post Frame Size (in) "Y"	Clamp Codes "XY"
2 1/2	1 1/4	EB
	1 1/2	EC
3	1 1/4	FB
	1 1/2	FC
3 1/2	1 1/4	GB
	1 1/2	GC
4	1 1/4	HB
	1 1/2	HC

4/0 AWG Flexible Jumper Designation

Jumper Length (inches)

Left Hand (LH) or Right Hand (RH)

## A239 Pre-fabricated Gate Jumper Assemblies with Ground Lead

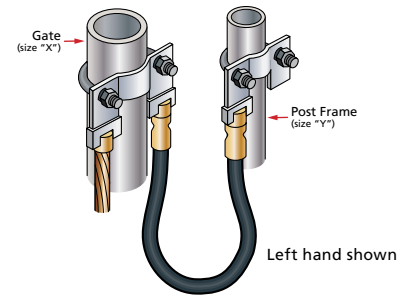

### Part Number Coding

Example:

**A239 "XY" 2S 24 2Q 3 LH**

Nominal Gate Size (in) "X"	Nominal Post Frame Size (in) "Y"	Clamp Codes "XY"
2 1/2	1 1/4	EB
	1 1/2	EC
3	1 1/4	FB
	1 1/2	FC
3 1/2	1 1/4	GB
	1 1/2	GC
4	1 1/4	HB
	1 1/2	HC

4/0 AWG Flexible Jumper Designation

Ground Lead Length (feet)

Left Hand (LH) or Right Hand (RH)

Ground Lead Cable Code (AWG)

2C = 1/0 Stranded  
2G = 2/0 Stranded  
2Q = 4/0 Stranded  
9F = Copper-Clad Steel #9, 19-Strand

Part No.	Nominal Gate Size (in)	Nominal Post Frame Size (in)	Jumper Cable Size (AWG)	Jumper Length (in)
A238EB2S12LH	2 1/2	1 1/4	4/0 Stranded	12
A238EB2S12RH	2 1/2	1 1/4	4/0 Stranded	12
A238EB2S18RH	2 1/2	1 1/4	4/0 Stranded	18
A238EC2S12LH	2 1/2	1 1/2	4/0 Stranded	12
A238EC2S24RH	2 1/2	1 1/2	4/0 Stranded	24
A238EC2S8LH	2 1/2	1 1/2	4/0 Stranded	8
A238FB2S24LH	3	1 1/4	4/0 Stranded	24
A238FC2S12LH	3	1 1/2	4/0 Stranded	12
A238FC2S18RH	3	1 1/2	4/0 Stranded	18
A238FC2S24LH	3	1 1/2	4/0 Stranded	24
A238GC2S12LH	3 1/2	1 1/2	4/0 Stranded	12
A238GC2S18RH	3 1/2	1 1/2	4/0 Stranded	18
A238GC2S24LH	3 1/2	1 1/2	4/0 Stranded	24
A238HB2S18LH	4	1 1/4	4/0 Stranded	18
A238HB2S18RH	4	1 1/4	4/0 Stranded	18
A238HC2S12LH	4	1 1/2	4/0 Stranded	12
A238HC2S15RH	4	1 1/2	4/0 Stranded	15
A238HC2S24LH	4	1 1/2	4/0 Stranded	24

Part No.	Nominal Gate Size (in)	Nominal Post Frame Size (in)	Jumper Cable Size (AWG)	Jumper Length (in)	Ground Lead Cable Size (AWG)	Ground Lead Length (ft)
A239EB2S242Q3LH	2 1/2	1 1/4	4/0 Stranded	24	4/0 Stranded	3
A239EB2S242Q3RH	2 1/2	1 1/4	4/0 Stranded	24	4/0 Stranded	3
A239EB2S242Q4LH	2 1/2	1 1/4	4/0 Stranded	24	4/0 Stranded	4
A239EC2S182Q6LH	2 1/2	1 1/2	4/0 Stranded	18	4/0 Stranded	6
A239EC2S242C8RH	2 1/2	1 1/2	4/0 Stranded	24	1/0 Stranded	8
A239EC2S242G4LH	2 1/2	1 1/2	4/0 Stranded	24	2/0 Stranded	4
A239EC2S249F6LH	2 1/2	1 1/2	4/0 Stranded	24	#9, 19-Strand	6
A239EC2S249F6RH	2 1/2	1 1/2	4/0 Stranded	24	#9, 19-Strand	6
A239FC2S142C2RH	3	1 1/2	4/0 Stranded	14	1/0 Stranded	2
A239FC2S242C6LH	3	1 1/2	4/0 Stranded	24	1/0 Stranded	6
A239FC2S242G4RH	3	1 1/2	4/0 Stranded	24	2/0 Stranded	4
A239FC2S242Q10R	3	1 1/2	4/0 Stranded	24	4/0 Stranded	10
A239GB2S242Q4LH	3 1/2	1 1/4	4/0 Stranded	24	4/0 Stranded	4
A239GB2S242Q4RH	3 1/2	1 1/4	4/0 Stranded	24	4/0 Stranded	4
A239GC2S122Q2RH	3 1/2	1 1/2	4/0 Stranded	12	4/0 Stranded	2
A239GC2S242Q4LH	3 1/2	1 1/2	4/0 Stranded	24	4/0 Stranded	4
A239GC2S242Q4RH	3 1/2	1 1/2	4/0 Stranded	24	4/0 Stranded	4
A239HB2S122Q4LH	4	1 1/4	4/0 Stranded	12	4/0 Stranded	4
A239HB2S242Q1RH	4	1 1/4	4/0 Stranded	24	4/0 Stranded	1
A239HB2S242Q4LH	4	1 1/4	4/0 Stranded	24	4/0 Stranded	4
A239HC2S142C2RH	4	1 1/2	4/0 Stranded	14	1/0 Stranded	2
A239HC2S182Q6LH	4	1 1/2	4/0 Stranded	18	4/0 Stranded	6
A239HC2S189F1RH	4	1 1/2	4/0 Stranded	18	#9, 19-Strand	1
A239HC2S242C10L	4	1 1/2	4/0 Stranded	24	1/0 Stranded	10
A239HC2S242G2RH	4	1 1/2	4/0 Stranded	24	2/0 Stranded	2

## Steel Pipe Sizes (Schedule 40)

Nominal Steel Pipe Size (in)	Outside Diameter (in)	Outside Diameter to Nearest Fraction (in)
1	1.315	1 1/16
1 1/4	1.660	1 5/8
1 1/2	1.900	1 7/8
2	2.375	2 3/8
2 1/2	2.875	2 7/8
3	3.500	3 1/2
3 1/2	4.000	4
4	4.500	4 1/2





## Cables

### A805A01F Series

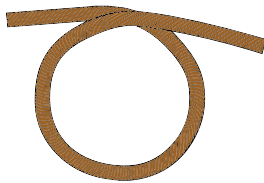

- Bare bronze cable
- Extra flexible
- 3/16" diameter

Part No.	Length (ft)
A805A01F-5	5
A805A01F-10	10
A805A01F-20	20

### A806A3F Series

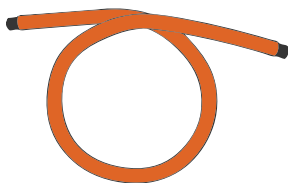

- Orange insulated bronze cable
- Extra flexible
- 3/16" diameter

Part No.	Length (ft)
A806A03F-5	5
A806A03F-10	10
A806A03F-20	20

### A822SAS Series

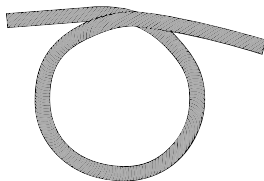

- Bare stainless steel cable
- Extra flexible
- 1/8" diameter

Part No.	Length (ft)
A822SAS-5	5
A822SAS-10	10
A822SAS-20	20

## Cable Reels and Coils

### A822SA111C & A822SB11C Series



- Galvanized steel
- 1/8" Orange insulated coiled cable

Part No.	Length (ft)
A822SA111C-5	5
A822SA111C-10	10
A822SA111C-20	20
A822SB111C20	20

### 20' Cable Reel B2618A



- Cable length: 20'
- Cable size: 3/32" diameter bare stainless steel
- Bare bronze cable
- Extra flexible

Features
Two 1/4" bolt holes to affix Uses only one cable terminator. Other end of cable is grounded through metal reel case. Plated bolting surfaces and base.

### 50' Cable Reel B2618B



- Cable length: 50'
- Cable size: 3/32" diameter bare stainless steel

Features
Two 1/2" bolt holes to affix Uses only one cable terminator. Other end of cable is grounded through metal reel case. Plated bolting surfaces and base.

# Static Grounding and Bonding

## Static Grounding Clamps

### B2610A Spring Clamp



- Bare bronze cable
- Extra flexible

#### Features

Die Cast Aluminum  
 Max Jaw Opening: 1"  
 Throat Depth: 1"  
 Max Cable Size: 1/8"  
 Contact Points: 2 ea., Stainless Steel  
 Release Harness: Not Available

### B2611A Spring Clamp



#### Features

Die Cast Aluminum  
 Max Jaw Opening: 1-1/2"  
 Throat Depth: 2"  
 Max Cable Size: 3/16"  
 Contact Points: 3 ea., Stainless Steel  
 Release Harness: Included

### B2614A Spring Clamp



#### Features

Bronze  
 Max Jaw Opening: 1"  
 Throat Depth: 2-1/2"  
 Max Cable Size: 3/16"  
 Length: 9-1/2"  
 Contact Points: 3 ea., Stainless Steel  
 Release Harness: Included

### B2617A Aircraft Grounding Clamp



#### Features

Die Cast Aluminum  
 Max Jaw Opening: 3/4"  
 Throat Depth: 5/32"  
 Max Cable Size: 3/16"  
 Contact Points: Plated Steel  
 Release Harness: Not Available  
 Fits rods up to 3/4" and CADWELD® Aircraft Grounding Receptacles B165 and B166

## "C" Clamps

### "C" Clamp B2615B



#### Features

Bronze  
 Max Jaw Opening: 1-1/4"  
 Throat Depth: 1-1/2"  
 Max Cable Size: 3/16"  
 Length: 2-1/2"  
 Contact Point: Bronze, Includes Crimp Lug

## Static Grounding Components

### B750A Static Grab Bar

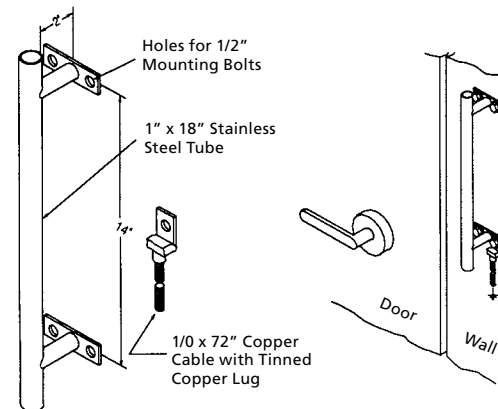

- Stainless Steel
- Length: 18"
- Furnished with 6' of 1/0 AWG copper conductor with a tinned copper lug
- CADWELD® lug attached for connecting to the ground system

Application – Touch before entry into static controlled assembly area.







# Ground Resistance Testers

ERICO offers a complete range of ground resistance testers. The units are lightweight and portable for ease of use in the field. Their robust design and splash-proof construction help them withstand extreme conditions. The large LCD displays show required test connections and features a complete automatic test sequence for selected operations.



## Ground Tester Kits



EST3640



EST4620



EST4630



EST6472

- Fall-of-Potential method
- Auto-ranging: automatically selects the optimum range
- Designed to reject high levels of noise and interference
- Extremely simple to operate: connect – press – read
- LED on faceplate informs operator of high input noise, high auxiliary rod resistance and fault connections
- May also be used for continuity tests on bonding
- Rugged dustproof and rainproof field case
- Color-coded terminals
- CE Mark

Part No.	Description	Unit Weight (lbs)
EST3640	2- and 3-Point Ground Tester Kit	35.01
	<ul style="list-style-type: none"> <li>• Measures ground resistance (2- and 3-Point)</li> <li>• Battery powered</li> </ul>	
EST4620	2-, 3- and 4-Point Ground Tester Kit	35.07
	<ul style="list-style-type: none"> <li>• Measures ground resistance (2- and 3-Point) and soil resistivity (4-Point)</li> <li>• Step voltage tests and touch potential measurements</li> <li>• Battery powered</li> </ul>	
EST4630	2-, 3- and 4-Point Ground Tester Kit	35.01
	<ul style="list-style-type: none"> <li>• Measures ground resistance (2- and 3-Point) and soil resistivity (4-Point)</li> <li>• Step voltage tests and touch potential measurements</li> <li>• AC powered with rechargeable NiMH batteries</li> </ul>	
EST6472	2-, 3- and 4-Point Ground Tester Kit (**)	37.08
	<ul style="list-style-type: none"> <li>• 3-Point Fall-of-Potential measurement with manual or automatic frequency selection and automatic lead compensation</li> <li>• 4-Point soil resistivity measurement with automatic calculation of Rho and user selection of Wenner or Schlumberger test method</li> <li>• Earth coupling testing (3-Point earth coupling measurement)</li> <li>• Manual or automatic frequency scan from 40 to 513Hz for test accuracy in electrically noisy environments</li> <li>• Selectable test voltage 16 or 32V up to 250mA test current</li> <li>• 2- and 4-Wire DC resistance measurement (Bond testing) with automatic polarity reversal</li> <li>• Ground resistance with 2 clamps (no auxiliary rods)</li> <li>• Includes DataView® software for data storage, real-time display, analysis, report generation and system configuration</li> <li>• Auto-off power management</li> <li>• Automatic recognition of all electrode connections and their resistance value</li> <li>• Stores up to 512 complete test results in internal memory</li> <li>• Optically isolated USB communication</li> <li>• AC powered with rechargeable NiMH batteries from wall charger or vehicle power</li> </ul>	

\* Kits include:

- Two 300' color-coded leads on spools (red and blue)
- Two 100' color-coded leads (green and black)
- Four 14.5" T-shaped auxiliary ground electrodes
- One set of five spaded lugs
- 100' tape measure
- Carrying bag

\*\* Clamp-on probe sold separately for use with EST6472



## Handheld Ground Resistance Tester



Part No.	Description
EST401	Handheld Ground Resistance Tester



## Cable Reels



- 2 Heavy duty insulated thermoplastic 11" diameter reels with integral carrying handle, rugged base, and cranks for fast test lead retrieval
- Test leads are marked every 25' for easy auxiliary ground test stake positioning
- 500' of #18 silicone rubber insulated wire on each reel, two different colors for easy stake identification
- The far end of test lead remains attached to reel base, which eliminates tangling and speeds up the process of test stake deployment. A jack built into the reel base connects the test lead to the test stake with an included jumper

Part No.	Description	Unit Weight (lbs)
ESTREELKIT500	500 ft. Cable Reels	17.0

## Ground Resistance Tester Model Comparison

Models	EST3640	EST4610	EST4630
Type of Measurements	2 & 3 Point	2, 3, & 4 Point	2, 3, & 4 Point
Soil Resistivity Test	No	Yes	Yes
Range	20Ω	200Ω	2000Ω
Measurement Ranges	0.00 to 19.99Ω	20.0 to 199.9Ω	200 to 1999Ω
Resolution	10mΩ	100mΩ	1Ω
Test Current	10mA	1mA	0.1mA
Open Voltage	<42V Peak		
Operating Frequency	128 Hz Square Wave		
Accuracy	+/- 2% of Reading +/- 1ct		+/- 3% of Reading +/- 3ct
Fuse Protection	0.1A, >250V, 0.25 x 1.25"; 30kA Interrupt Capacity	High breaking capacity, 0.1A, >250V	
	Low Battery Indication		
Test Kit Included	Yes	Yes	Yes

## Clamp-on Probe



Part No.	Description	Unit Weight (lbs)
ESR182	Clamp-on Probe for use with EST6472 ***	3.0

# Technical Information

## Concentric Stranded Conductor Sizes

Size (AWG/MCM/mm <sup>2</sup> )	Circular Mils	Stranding	Nominal O.D. of Strand	Approx. O.D. (inches)	Approx. O.D. (mm)	Weight (lbs/mft)	CADWELD Cable Code
8 AWG	16,510	Solid	–	0.1285	3.26	50.0	1D
8 AWG	16,510	7/.0486"	0.0486	0.1460	3.71	50.1	1E
6 AWG	26,240	Solid	–	0.1620	4.11	79.5	1G
6 AWG	26,240	7/.0612"	0.0612	0.1840	4.67	81.1	1H
16 mm <sup>2</sup>	31,600	7/1.17	0.0461	0.2010	5.11	96.1	W3
4 AWG	41,740	Solid	–	0.2043	5.19	126.3	1K
4 AWG	41,740	7/.0772"	0.0772	0.2320	5.89	129.0	1L
4 AWG	41,740	19/.0469"	0.0469	0.2350	5.97	129.0	1L
25 mm <sup>2</sup>	49,300	7/2.14 mm	0.0843	0.2530	6.43	152.5	Y1
25 mm <sup>2</sup>	49,300	19/1.35	0.0531	0.2660	6.76	152.5	Y1
2 AWG	66,360	Solid	–	0.2576	6.54	200.9	1T
2 AWG	66,360	7/.0974"	0.0974	0.2920	7.42	204.9	1V
2 AWG	66,360	19/.0591"	0.0591	0.2920	7.42	205.0	1V
35 mm <sup>2</sup>	66,360	19/1.53 mm	0.0602	0.3010	7.65	211.0	Y2
50 mm <sup>2</sup>	98,500	19/1.78 mm	0.0701	0.3500	8.89	287.6	Y3
1/0 AWG	105,600	Solid	–	0.3249	8.25	319.5	2B
1/0 AWG	105,600	7/.1228"	0.1228	0.3690	9.37	326.0	2C
1/0 AWG	105,600	19/.0745"	0.0745	0.3730	9.47	326.0	2C
2/0 AWG	133,100	Solid	–	0.3648	9.27	402.8	2F
2/0 AWG	133,100	7/.1379"	0.1379	0.4140	10.52	410.9	2G
2/0 AWG	133,100	19/.0837"	0.0837	0.4190	10.64	410.9	2G
70 mm <sup>2</sup>	138,000	19/2.14 mm	0.0843	0.4210	10.69	415.3	Y4
3/0 AWG	167,800	Solid	–	0.4096	10.40	507.8	2K
3/0 AWG	167,800	7/.1548"	0.1548	0.4650	11.81	518.0	2L
3/0 AWG	167,800	19/.0940"	0.0940	0.4700	11.94	518.0	2L
95 mm <sup>2</sup>	187,000	37/1.78 mm	0.0700	0.4910	12.47	576.5	Y5
95 mm <sup>2</sup>	187,000	19/2.52	0.0992	0.4960	12.60	576.5	Y5
4/0 AWG	211,600	Solid	–	0.4600	11.68	610.5	2P
4/0 AWG	211,600	7/.1739"	0.1739	0.5220	13.26	653.0	2Q
4/0 AWG	211,600	19/.1055"	0.1055	0.5280	13.41	653.0	2Q
120 mm <sup>2</sup>	237,000	37/2.03 mm	0.0799	0.5600	14.22	737.1	Y6
250 MCM	250,000	19/.1147"	0.1147	0.5750	14.61	771.0	2V
250 MCM	250,000	37/.0822"	0.0822	0.5750	14.61	771.0	2V
150 mm <sup>2</sup>	296,000	37/2.25 mm	0.0886	0.6200	15.75	896.4	Y7
300 MCM	300,000	19/.1257"	0.1257	0.6290	15.98	926.9	3A
300 MCM	300,000	37/.0900"	0.0900	0.6290	15.98	926.9	3A
185 mm <sup>2</sup>	365,000	27/2.52 mm	0.0992	0.6950	17.65	1124.1	Y8
400 MCM	400,000	37/.1040	0.1040	0.7200	18.29	1235.2	3H
240 mm <sup>2</sup>	474,000	61/2.25 mm	0.0886	0.7970	20.24	1478.2	Y9
500 MCM	500,000	19/.1622"	0.1622	0.8130	20.65	1544.0	3Q
500 MCM	500,000	37/.1162"	0.1162	0.8130	20.65	1544.0	3Q
750 MCM	750,000	61/.1109"	0.1109	0.9980	25.35	2316.0	4L
500 mm <sup>2</sup>	987,000	61/3.20 mm	0.1260	1.1340	28.80	2990.8	W1
1000 MCM	1,000,000	61/.1280"	0.1280	1.1520	29.26	3088.0	4Y



## DSA Copper-bonded Conductor

Cable Stranding	Nominal Diameter	kcmil	Equivalent Copper Size*	CADWELD Cable Code
7/#10	.306	72.7	3 AWG	9A
7/#8	.385	115.6	1	9B
7/#7	.433	145.7	1/0	9C
7/#6	.486	183.8	2/0	9D
7/#5	.546	231.7	3/0	9E
19/#9	.572	248.8	3/0	9F
7/#4	.613	292.2	4/0	9L
19/#8	.642	313.7	4/0	9G
19/#7	.721	395.5	250 Kcmil	9H
37/#9	.801	484.4	300	7W
19/#6	.810	498.8	350	9J
37/#8	.899	610.9	400	7V
19/#5	.910	628.9	450	9K
37/#7	1.010	770.3	500	9M

\*Approximate based on fusing current calculations

## Bare Copper-bonded Conductor

Nominal Size	Material	Type	Thread Size	Body Dia.	CADWELD Ground Rod Code
1/2"	Copper-bonded	Sectional	9/16"	.505	14
	Steel*	Plain		.500	14
	Copper-bonded	Plain		.475	15
	Copper-bonded	Sectional	1/2"	.447	13
5/8"	Copper-bonded	Sectional	5/8"	.563	16
	Steel*	Plain		.625	31
	Copper-bonded	Plain	3/4"	.563	16
	Copper-bonded	Sectional		.682	18
3/4"	Steel*	Plain	3/4"	.750	33
	Copper-bonded	Plain		.682	18
	Copper-bonded	Sectional	1"	.914	22
1"	Steel*	Plain	1"	1.000	37
	Copper-bonded	Plain		.914	22

\*Plain steel, stainless steel, stainless clad rods or galvanized steel.

## Rectangular Copper Busbar

Thickness (inches)	Width (inches)	Circular Mil Size	Weight (lbs per foot)	CADWELD Busbar Code
1/8	1	159,200	.484	CE
	1-1/2	238,700	.726	CG
	2	318,300	.969	CH
3/16	1	238,700	.727	DE
	2	477,500	1.45	DH
	1	318,300	.969	EE
	1-1/2	477,500	1.45	EG
1/4	2	636,600	1.94	EH
	3	954,900	2.91	EK
	4	1,273,000	3.88	EM
	1	477,500	1.45	GE
	1-1/2	716,200	2.18	GG
3/8	2	954,900	2.91	GH
	3	1,432,000	4.36	GK
	4	1,910,000	5.81	GM
	2	1,273,000	3.88	JH
1/2	3	1,910,000	5.81	JK
	4	2,546,000	7.75	JM

## Reinforcing Bars

Rebar Sizes	Nominal Dimensions		Equivalent Copper Sizes*	CADWELD Rebar Code
	Dia. (inches)	Cross-Sectional Area (Sq. inches)		
3	.375	.11	9 AWG	51
4	.500	.20	7	52
5	.625	.31	5	53
6	.750	.44	3	54
7	.875	.60	2	55
8	1.000	.79	1	56
9	1.128	1.00	1/0	57
10	1.270	1.27	2/0	58
11	1.410	1.56	3/0	59
14	1.693	2.25	250 kcmil	60
18	2.257	4.00	450	61

\*Based on 8% IACS, rounded to the next higher commercial copper size.

### Useful Conversions

#### Area

Square Inches x 1273 = kcmil  
 Square Millimeters x 1.974 = kcmil  
 kcmil x 0.5067 = Square Millimeters

#### Density

Copper: 0.323 lb/in<sup>3</sup>  
 Steel: 0.283 lb/in<sup>3</sup>

# Technical Information

## Steel Pipe Sizes

Standard Weight  
(Schedule 40)

ASTM® A53-90-B  
ANSI®/ASME® B36.10M-1985

Nominal Size (inches)	O.D. (inches)	Wall Thickness (inches)	CADWELD Mold Code
1	1.315	.133	1
1-1/4	1.660	.140	1.25
1-1/2	1.900	.145	1.50
2	2.375	.154	2
2-1/2	2.875	.203	2.50
3	3.500	.216	3
3-1/2	4.000	.226	3.50
4	4.500	.237	4
5	5.563	.258	5
6	6.625	.280	6
8	8.625	.322	8
10	10.750	.365	10

## Other Standard Sections used for Fence Posts

Section	CADWELD Mold Code
1-1/2" square	PS15
2" square	PS20
2-1/2" square	PS25
3" square	PS30*
1.875 x 1.625 x .133 "H"	PH1
2.25 x 1.95 .143 "H"	PH2

\*For D or F mold price only.

### WARNING

ERICO products shall be installed and used only as indicated in ERICO's product instruction sheets and training materials. Instruction sheets are available at [www.erico.com](http://www.erico.com) and from your ERICO customer service representative. Improper installation, misuse, misapplication or other failure to completely follow ERICO's instructions and warnings may cause product malfunction, property damage, serious bodily injury and death.

### WARRANTY

ERICO products are warranted to be free from defects in material and workmanship at the time of shipment. NO OTHER WARRANTY, WHETHER EXPRESS OR IMPLIED (INCLUDING ANY WARRANTY OF MERCHANTABILITY OR FITNESS FOR A PARTICULAR PURPOSE), SHALL EXIST IN CONNECTION WITH THE SALE OR USE OF ANY ERICO PRODUCTS. Claims for errors, shortages, defects or nonconformities ascertainable upon inspection must be made in writing within 5 days after Buyer's receipt of products. All other claims must be made in writing to ERICO within 6 months from the date of shipment or transport. Products claimed to be nonconforming or defective must, upon ERICO's prior written approval in accordance with its standard terms and procedures governing returns, promptly be returned to ERICO for inspection. Claims not made as provided above and within the applicable time period will be barred. ERICO shall in no event be responsible if the products have not been stored or used in accordance with its specifications and recommended procedures. ERICO will, at its option, either repair or replace nonconforming or defective products for which it is responsible or return the purchase price to the Buyer. THE FOREGOING STATES BUYER'S EXCLUSIVE REMEDY FOR ANY BREACH OF ERICO WARRANTY AND FOR ANY CLAIM, WHETHER SOUNDING IN CONTRACT, TORT OR NEGLIGENCE, FOR LOSS OR INJURY CAUSED BY THE SALE OR USE OF ANY PRODUCT.

### LIMITATION OF LIABILITY

ERICO excludes all liability except such liability that is directly attributable to the willful or gross negligence of ERICO's employees. Should ERICO be held liable its liability shall in no event exceed the total purchase price under the contract. ERICO SHALL IN NO EVENT BE RESPONSIBLE FOR ANY LOSS OF BUSINESS OR PROFITS, DOWNTIME OR DELAY, LABOR, REPAIR OR MATERIAL COSTS OR ANY SIMILAR OR DISSIMILAR CONSEQUENTIAL LOSS OR DAMAGE INCURRED BY BUYER.





ERITECH® products designed to help provide data center electrical protection solutions.



Bonding requirements for permanently installed swimming pools to help eliminate voltage gradients.

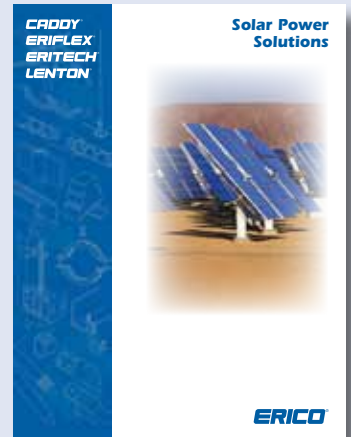

Grounding, lightning protection, electrical connection and cable management solutions for the solar power industry.



ERITECH products designed to help protect power utility facilities worldwide.



Foundation grounding and construction, bonding, power connections, surge protection, and lightning protection products for the wind energy industry.

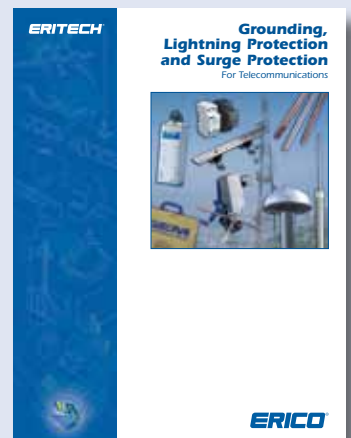

Product solutions to help protect telecommunications facilities against electrical noise, lightning induced surges and transients.



ERICO offers a diverse range of technically advanced lightning protection systems and products to meet industry standards and requirements.



Grounding, bonding, lightning protection and surge protection solutions necessary to help provide comprehensive facility electrical protection.

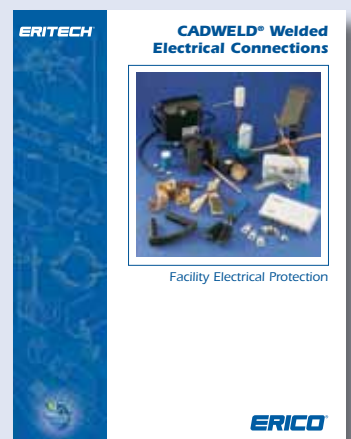

A range of CADWELD products, including information on molds and connection types.

# ERICO®



[www.erico.com](http://www.erico.com)



**AUSTRALIA**  
Phone 1-800-263-508  
Fax 1-800-423-091

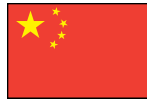

**CHINA**  
Phone +86-21-3430-4878  
Fax +86-21-5831-8177



**HUNGARY**  
Phone 06-800-16538  
Fax +39-0244-386-107



**NORWAY**  
Phone 800-100-73  
Fax 800-100-66



**SWITZERLAND**  
Phone 0800-55-86-97  
Fax 0800-55-96-15



**BELGIUM**  
Phone 0800-757-48  
Fax 0800-757-60



**DENMARK**  
Phone 808-89-372  
Fax 808-89-373



**INDONESIA**  
Phone +62-21-575-0941  
Fax +62-21-575-0942



**POLAND**  
Phone +48-71-349-04-60  
Fax +48-71-349-04-61



**THAILAND**  
Phone +66-2-267-5776  
Fax +66-2-636-6988



**BRAZIL**  
Phone +55-11-3623-4333  
Fax +55-11-3621-4066



**FRANCE**  
Phone 0-800-901-793  
Fax 0-800-902-024



**ITALY**  
Phone 800-870-938  
Fax 800-873-935



**SINGAPORE**  
Phone +65-6-268-3433  
Fax +65-6-268-1389



**UNITED ARAB  
EMIRATES**  
Phone +971-4-881-7250  
Fax +971-4-881-7270



**CANADA**  
Phone +1-800-677-9089  
Fax +1-800-677-8131



**GERMANY**  
Phone 0-800-189-0272  
Fax 0-800-189-0274



**MEXICO**  
Phone +52-55-5260-5991  
Fax +52-55-5260-3310



**SPAIN**  
Phone 900-993-154  
Fax 900-807-333



**UNITED KINGDOM**  
Phone 0808-2344-670  
Fax 0808-2344-676



**CHILE**  
Phone +56-2-370-2908  
Fax +56-2-369-5657



**HONG KONG**  
Phone +852-2764-8808  
Fax +852-2764-4486



**NETHERLANDS**  
Phone 0800-0200-135  
Fax 0800-0200-136



**SWEDEN**  
Phone 020-790-908  
Fax 020-798-964



**UNITED STATES**  
Phone 1-800-753-9221  
Fax +1-440-248-0723

ANSI is a registered trademark of the American National Standards Institute. ASME is a registered trademark of the American Society of Mechanical Engineers. ASTM is a registered trademark of American Society for Testing and Materials. BICSI is a registered trademark of BICSI, Inc. CSA is a registered trademark of The Canadian Standards Association Int'l. cULus is a registered trademark of Underwriters Laboratories, Inc. DataView is a registered trademark of Chauvin Arnoux, Inc. EIA is a registered service mark of the Electronic Industries Alliance. IEEE is a registered trademark of The Institute of Electrical and Electronics Engineers, Inc. NEC is a registered trademark of, and National Electrical Code (NEC) standard is a copyright of the National Fire Protection Association. NEMA is a registered trademark of the National Electrical Manufacturers Association. NFGC is a registered trademark of, and National Fuel Gas Code (NFGC) standard is a copyright of the National Fire Protection Association. NFPA is a registered trademark of the National Fire Protection Association. SAE is a registered trademark of SAE International. TIA is a registered service mark of the Telecommunications Industry Association.

Copyright ©2000, 2006, 2007, 2009, 2011, 2012 ERICO International Corporation. All rights reserved.  
CADDY, CADWELD, CRITEC, ERICO, ERIFLEX, ERITECH, and LENTON are registered trademarks of ERICO International Corporation.

E1081C-NAEN E590CT12NAEN 75M0612