

product

Versatile Floodlight with hinged lens frame and Hydroformed reflector. Field adjustable vertical and horizontal lamp positions.

Color: Bronze

Weight: 7.6 lbs

**Project:**

**Type:**

**Prepared By:**

**Date:**

**Lamp Info**

Type: Triple 64W  
 Watts: 64W  
 Shape/Size: N/A  
 Base: N/A  
 ANSI: N/A  
 Hours: 12,000  
 Lamp Lumens: 4,800  
 Efficacy: 67 LPW

**Ballast Info**

Type: Electronic QT  
 120V: N/A  
 208V: N/A  
 240V: N/A  
 277V: 0.3A  
 Input Watts: 72W  
 Efficiency: 89%

## Technical Specifications

**Listings**

**UL Listing:**

Suitable for wet locations. Suitable for ground mounting.

**Electrical**

**Photocell:**

Button Photocell 277V included. Photocell is compatible with 208V-277V.

**Socket:**

Porcelain 4kv Pulse Rated socket with nickel plated screw shell.

**Construction**

**Housing:**

Precision die cast aluminum. 1/2" NPS threaded arm with locking swivel.

**Reflector:**

Hydroformed aluminum. Field adjustable vertical or horizontal.

**Lens Gasket:**

High temperature tubular silicone set in die cast retaining groove remains in place during relamping.

**Lens Frame:**

Precision die cast aluminum. Hinged for easy access.

**Finish:**

Our environmentally friendly polyester powder coatings are formulated for high-durability and long-lasting color, and contains no VOC or toxic heavy metals.

**Ground Mounting:**

Use the new MPM19 PVC Mighty Post with aluminum cap for sturdy installation.

**EPA:**

0.6

**Other**

**Country of Origin:**

Designed by RAB in New Jersey and assembled in the USA by RAB's IBEW Local 3 workers.

**Buy American Act Compliant:**

This product is a COTS item manufactured in the United States, and is compliant with the Buy American Act.

**Recovery Act (ARRA) Compliant:**

This product complies with the 52.225-21 "Required Use of American Iron, Steel, and Manufactured Goods-- Buy American Act-- Construction Materials (October 2010).

**Trade Agreements Act Compliant:**

This product is a COTS item manufactured in the United States, and is compliant with the Trade Agreements Act.

**GSA Schedule:**

Suitable in accordance with FAR Subpart 25.4.

## Dimensions

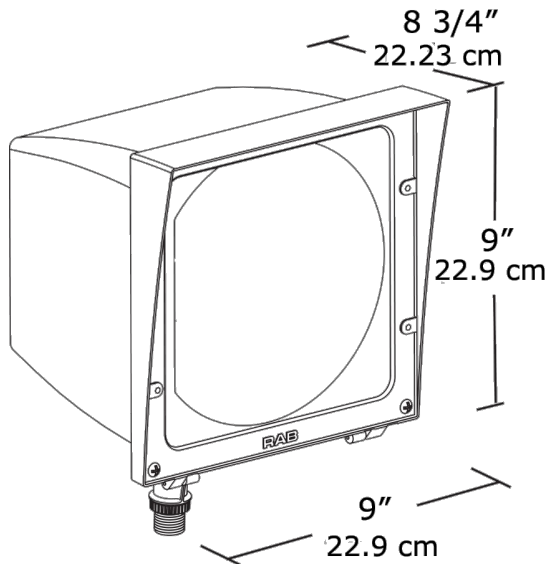

## Features

- Fins for heat dissipation extend lamp & ballast tube
- Hinged lens frame is captive during relamping
- Silicone gasket for durable weatherproofing
- Hydroformed reflector is field adjustable to vertical or horizontal lamp positions
- Long life lamp included
- Precision die cast aluminum housing and lens frame with durable polyester powder coating
- EZ Grip locknut matches fixture finish and can be adjusted with fingers, pliers or a screwdriver