



# Mark 7 0-10V

## MARK 7 0-10V ELE DIMMING BALLAST (2) F32T8 120-277V

The Mark 7 0-10V series of dimmable electronic ballasts offer maximum versatility by incorporating separate control leads for use with a wide array of controllers, including occupancy sensors, daylight harvesting controls, and building management systems from more than 40 manufacturers. When paired with linear fluorescent and 4-pin compact fluorescent lamps, these ballasts optimize the benefits of such popular sustainable lighting techniques as daylight harvesting, occupancy sensing, and load shedding to satisfy the need for an affordable, flexible and versatile controllable lighting solution.

### Product data

General Information	
Lamp Type	F32T8
Number of Lamps	2 piece/unit
Ballast Type	Dimmable Fluorescent
Base Model	IZT2PSP32SC
Suitable For Outdoor Use	Yes
Automatic Restart	Yes

Operating and Electrical	
Input Voltage	120 to 277 V
Input Frequency	50 to 60 Hz
Total Harmonic Distortion USA	10 %
Ignition Method	Programmed Start
Crestfactor (Nom)	1.6
Ignition Time (Nom)	1.5 s
Ballast Factor (Max)	1.00
Ballast Factor (Min)	0.05
Power Factor (Nom)	0.99

Input Current (Max)	0.54 A
Input Current (Min)	0.23 A
Input Current (Nom)	- A
Input Power (Max)	67 W
Input Power (Min)	11 W
Rated Lamp Power	32 W

Wiring	
Color Input Terminals	No terminals
Color Output Terminals	No terminals
Wire Striplength	0.50/0.375 mm
Control Wire Gauge	18AWG
Lamp Connection	Series
Wire Length by Color	See Data Sheet
Wire Gauge (Nom)	18AWG mm
Wire Type	Solid
Remote Wiring Configuration Allowed	Yes
Tandem Wiring Configuration Allowed	Yes

## Mark 7 0-10V

Through Wiring Configuration Allowed	Yes
Max Ballast-Lamp Distance Remote Wiring	6'
Max Ballast-Lamp Distance Tandem Wiring	Any = 6'
Max Ballast-Lamp Distance Through Wiring	Any = 6'
Connector Type	No connector

### Temperature

T-Case Maximum (Nom)	70 °C
----------------------	-------

### Mechanical and Housing

Housing Material	Metal
Housing	SC
Housing Dimensions	9.5" x 1.7" x 1.18"

### Approval and Application

EMC Immunity Standard	FCC Consumer
Approval Marks	CSA certificate UL certificate CEC Listing CEE Rated CSA E NEMA Premium RoHS Compliant

Hum And Noise Level	A
UL Recognized	No

### Product Data

Order product name	MARK 7 0-10V ELE DIMMING BALLAST (2) F32T8 120-277V
EAN/UPC - Product	781087134849
Order code	913701260902
Numerator - Quantity Per Pack	1
Numerator - Packs per outer box	20
Material Nr. (12NC)	913701260902
Net Weight (Piece)	441.000 g

## Dimensional drawing

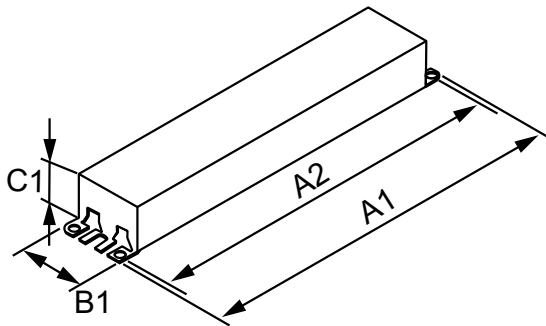

ELE DIMMING BALLAST (2) F32T8 120-277V

Product	A1	A2	B1	C1
MARK 7 0-10V ELE DIMMING BALLAST (2) F32T8 120-277V	9.50 in	8.90 in	1.70 in	1.18 in

