

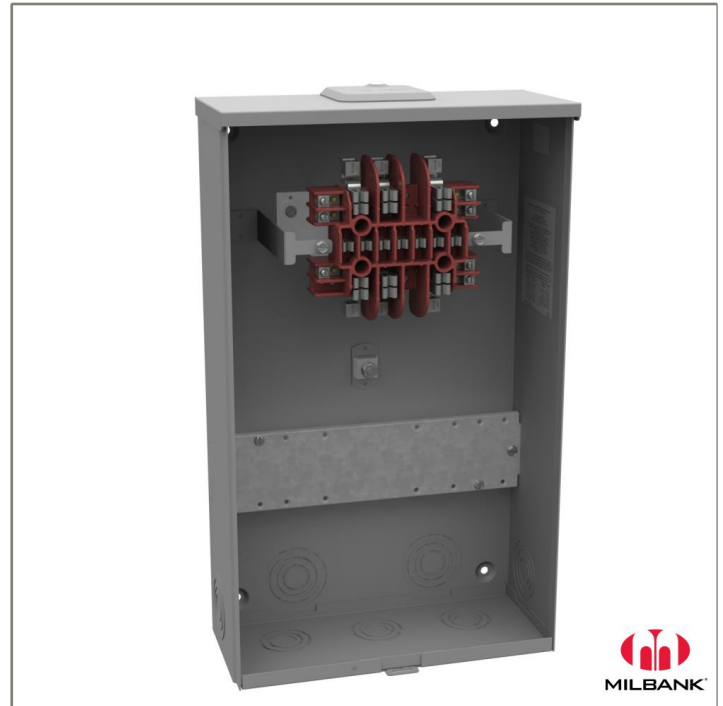

Catalog Number: UC3433-XL  
Item Description: 20A 13T RT TS PROV OU  
UPC Code: 784572144477

Brand Name: Milbank  
Type: Ring Type Meter Socket  
Application: Meter Socket  
Standard: UL Listed  
Voltage Rating: 600 Volts Alternating Current  
Amperage Rating: 20 Continuous Ampere  
Phase: 3 Phase  
Frequency Rating: 60 Hertz  
Number Of Cutouts: 0  
Cable Entry: Overhead and Underground  
Terminal: Single Mechanical Line Side and Single Mechanical Load Side  
Mounting: Surface Mount  
Enclosure: Type 3R, G90 Galvanized Steel with Powder Coat Finish



Additional Specifications: Number of Jaws:13 Terminal  
Hub Opening and Closing Plates:Small Closing Plate  
Hub Opening and Closing Plates:Small Closing Plate  
Hub Opening and Closing Plates:Small Closing Plate  
Hub Opening and Closing Plates:Small Closing Plate  
Hub Opening and Closing Plates:Small Closing Plate

*Utility requirements may vary. Always consult the serving utility for their requirements prior to ordering or installing this equipment. This product must always be installed by a licensed electrician. Installation of this equipment may require local electrical inspector approval.*

FEATURE TABLE		
ITEM	QTY	DESCRIPTION
A	4	STD. MNTG. EMOSS
B	7	½, ¾, 1, 1¼, 1½, 2 CONC. K.O.

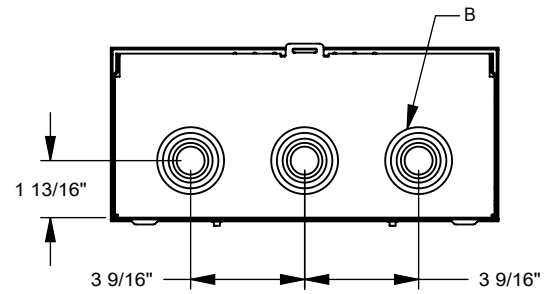
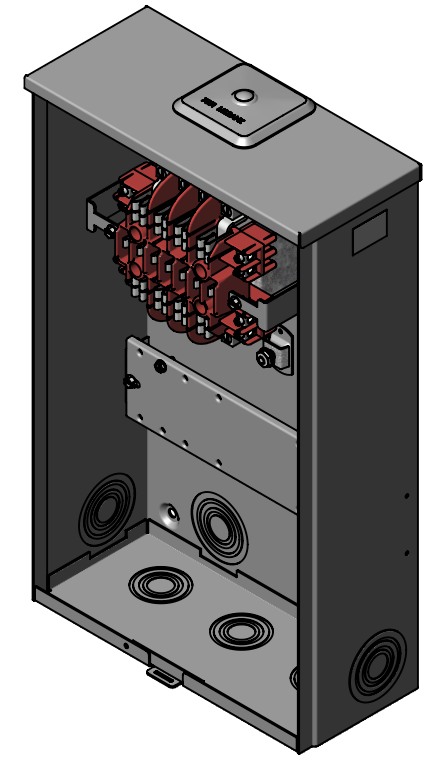
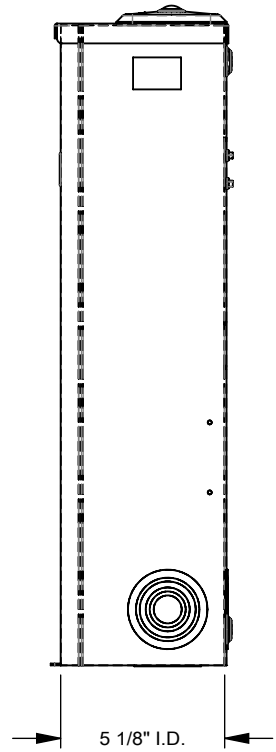
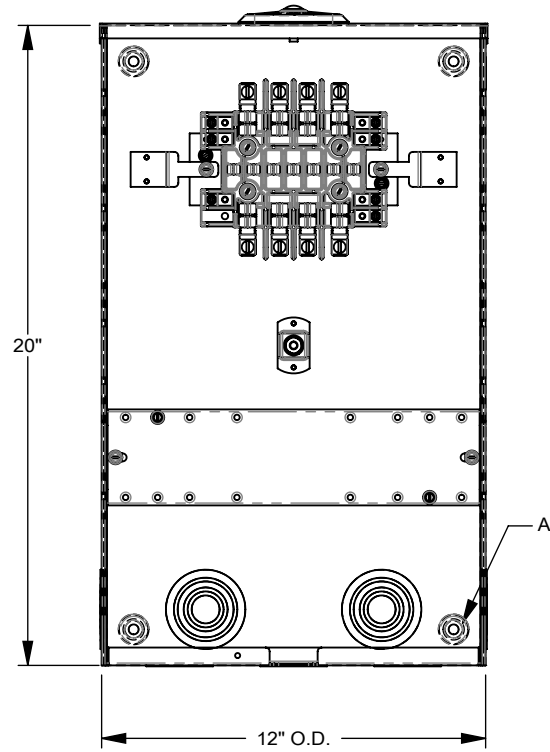

Version:

1

All dimensions are +/- 1/16".  
 Drawing views are not to scale.  
 Utility requirements for this equipment may vary. Always consult the serving utility for their requirements prior to ordering or installing this equipment. This product must be installed by a licensed electrician. Installation of this equipment may require local electrical inspector approval.