



Project: _____

Fixture Type: _____

Location: _____

Contact/Phone: _____

5" UNIVERSAL TC HOUSING

INCANDESCENT LAMPS

TC20

PRODUCT DESCRIPTION

TC Housing design for use in non-insulated areas • If installed where insulation is present, the insulation must be pulled back 3" from all sides of the TC housing.

PRODUCT SPECIFICATIONS

Lamp Lamp ratings based on trim selected—see reverse.

Socket Medium base porcelain with nickel-plated copper screw shell • Drop socket with spring to accommodate certain trim installation.

Trims Trim selection shown on reverse.

Labels U.L. listed for through-branch wiring, damp locations and IP • Product thermally protected against improper use of lamps or insulation • Union made AFL-CIO • UL Listed/CSA certified • Trims 210, 211 and 212 are wet location approved for covered ceiling applications • Trims 215 and 216 are wet location approved for covered ceiling applications, **when used with outdoor rated lamps.**

Testing All reports are based on published industry procedures; field performance may differ from laboratory performance.

Product specifications subject to change without notice.

INSTALLATION

Real Nail 3 Bar Hangers Telescoping, patent-pending Real Nail 3 system permits quick placement of housing anywhere within 24" O.C. joists or suspended ceilings • Integral T-bar notch and clip secures housing in suspended ceiling grid – no accessory clips required • 24" expansion stop allows quick placement of fixture in standard grid spacing • Bars scored in two locations for fast, clean breaking, allowing housing installation in tight applications • Bars captive to mounting frame • Edge-mounted for extra strength • Captive bugle-headed ring shank nail for quick one-step installation and easy removal with claw hammer for fixture relocation • Quick-Loc slot (location identified on the mounting frame) and oversized locking set screw lock fixture in position • Bar hanger foot contoured to align to bottom of construction joist • Alternate mounting holes included.

Junction Box Pre-wired junction box provided with (5) ½" and (1) ¾" knockouts, (4) Non-metallic sheathed cable connectors and ground wire, U.L. listed/CSA certified for through-branch wiring, maximum 8 No. 12 AWG 90° C branch circuit conductors (4 in, 4 out) • Junction box provided with removable access plates • Knockouts equipped with pryout slots.

Mounting Frame 22-gauge die-formed galvanized steel mounting frame • Rough-in section (junction box, mounting frame, housing and bar hangers) fully assembled for ease of installation • Sight lines embossed on mounting frame to allow for easy viewing when aligning fixtures.

Housing .032" aluminum housing • Housing is vertically adjustable to accommodate up to a 1" ceiling thickness.

PRODUCT CODES

Catalog Number	Input Voltage	Lamp Rating (max.)
TC20	120V	A19/BR30/PAR20/PAR30/PAR30L/R20 (See reverse for max. trim rating)

REV-9/09

DIMENSIONS

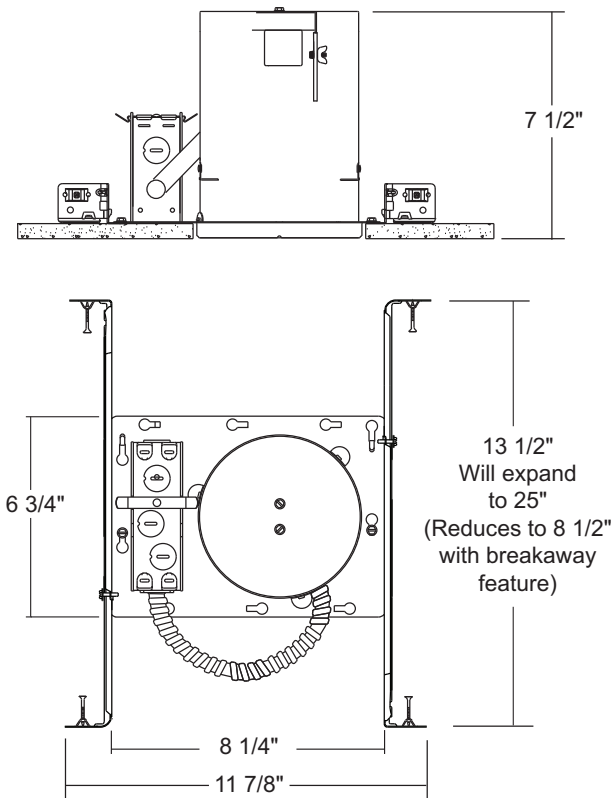

















5 5/8" CEILING CUTOUT

5" UNIVERSAL TC HOUSING

INCANDESCENT LAMPS

TC20

TRIMS/LAMPS

	Cat. No.	Description	Max. Lamp Rating
	 201-WH	Open Frame	65W BR30
**	 203B-WH 203W-WH	Deep Black Baffle Deep White Baffle	75W PAR30, 65W BR30
**	 205B-WH 205W-WH 205B-SC 205B-ABZ	BR30/PAR30 Black Baffle BR30/PAR30 White Baffle BR30/PAR30 Black Baffle BR30/PAR30 Black Baffle	75W PAR30, 65W BR30
**	 204C-WH 204G-WH 204B-WH 204PT-SC 204HZ-WH 204W-WH 204WHZ-WH 204WHZ-ABZ	BR30/PAR30 Cone - Clear Alzak® BR30/PAR30 Cone - Gold Alzak® BR30/PAR30 Cone - Black Alzak® BR30/PAR30 Cone - Pewter Alzak® BR30/PAR30 Cone - Haze BR30/PAR30 Cone - White Gloss BR30/PAR30 Cone - Wheat Haze BR30/PAR30 Cone - Wheat Haze	75W PAR30L, 75W PAR30, 65W BR30
**	 206C-WH 206G-WH 206B-WH 206PT-SC 206HZ-WH 206WHZ-WH 206WHZ-ABZ	Deep Cone - Clear Alzak® Deep Cone - Gold Alzak® Deep Cone - Black Alzak® Deep Cone - Pewter Alzak® Deep Cone - Haze Deep Cone - Wheat Haze Deep Cone - Wheat Haze	75W PAR30, 65W BR30
**	 207C-WH 207G-WH 207B-WH 207W-WH 207HZ-WH 207WHZ-WH	Cone - Clear Alzak® Cone - Gold Alzak® Cone - Black Alzak® Cone - Gloss White Cone - Haze Cone - Wheat Haze	50W PAR20/R20
	 215B-WH ♦♦ 215W-WH ♦♦	BR30/PAR30 Black Baffle BR30/PAR30 White Baffle	75W PAR30L, 75W PAR30 w/Socket Extender, 60W A19, 85W BR30
	 216C-WH ♦♦ 216G-WH ♦♦ 216W-WH ♦♦ 216HZ-WH ♦♦ 216WHZ-WH ♦♦	Cone - Clear Alzak® Cone - Gold Alzak® Cone - Gloss White Cone - Haze Cone - Wheat Haze	75W PAR30L, 75W PAR30 w/Socket Extender, 85W BR30, 60W A19 (Clear, Gold, Haze and Wheat Haze Cones), 40W A19 (White Cone)
	 208B-WH 208W-WH	Eyeball with Black Baffle Eyeball with White Baffle	50W PAR20/R20
	 529-WH 529-SC 529-ABZ	PAR30 Eyeball PAR30 Eyeball PAR30 Eyeball	75W PAR30
	 209-WH	Gimbal Ring with Flat Trim	75W PAR30
	 688B-WH 688W-WH	Gimbal Ring with Black Baffle Gimbal Ring with White Baffle	75W PAR30
	 689C-WH 689G-WH	Gimbal Ring in Clear Cone Gimbal Ring in Gold Cone	75W PAR30
	 210-WH ♦ 210-SC ♦ 210-ABZ ♦	Lensed Shower/Closet Light Lensed Shower/Closet Light Lensed Shower/Closet Light	40W A19
	 211-PW ♦	Shower Trim	40W A19
	 212-WH ♦ 212-SC ♦ 212-ABZ ♦	Shower Trim Shower Trim Shower Trim	75W PAR30, 60W A15

Trim Size: 6¼" O.D. (except Cat No. 529 - 6½" O.D.)
Trim Finish: ABZ - Classic Aged Bronze, BL - Black, GP - Graphite,
PW - Plastic White (Polycarbonate material shower trim),
SC - Satin Chrome, SL - Silver, WH - White.
Alzak is a registered trademark of Alcoa Corp.
Note: In Canada when insulation is present, Type IC fixtures must be used.

♦ UL Listed for use in wet location.

♦♦ UL Listed for use in wet location with outdoor rated lamp.

** NOTE: TR5 Trim Ring compatible with 203, 204, 205, 206, 207 trims.



1300 S. Wolf Road • Des Plaines, IL 60018 • Phone (847) 827-9880 • Fax (847) 827-2925
220 Chrysler Drive • Brampton, Ontario • Canada L6S 6B6 • Phone (905) 792-7335 • Fax (905) 792-0064
Visit us at www.junolightinggroup.com

Printed in U.S.A. ©2009 Juno Lighting, LLC.