

## Triplex Receptacle

Cat. No. AC315  
15A-125V

Cat. No. AC320  
20A-125V

### INSTALLATION INSTRUCTIONS

#### WARNINGS AND CAUTIONS:

- To be installed and/or used in accordance with appropriate electrical codes and regulations.
- If you are unsure about any part of these instructions, consult a qualified electrician.
- Disconnect power at circuit breaker or fuse when servicing, installing or removing device.

#### WARNINGS AND CAUTIONS:

- The Acenti™ Triplex Receptacle uses a multi-function self-grounding clip that provides an automatic ground connection in a properly grounded metal wall box.
- Use this device only with copper or copper clad wire. With aluminum wire use only devices marked CO/ALR or CU/AL.

#### Tools needed to install your Receptacle:

Slotted/Phillips Screwdriver  
Pliers  
Cutters

#### INSTALLING YOUR RECEPTACLE

**NOTE:** Use check boxes  when Steps are completed.

#### Step 1 WARNING: TO AVOID FIRE, SHOCK, OR DEATH; TURN OFF POWER at circuit breaker or fuse and test that power is off before wiring!

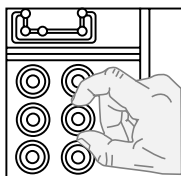
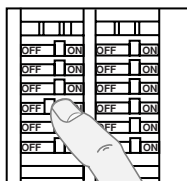

#### Step 2 Preparing wires:



This receptacle can be wired using side wire terminal screws or back wire clamps. Choose appropriate wire stripping specifications accordingly.

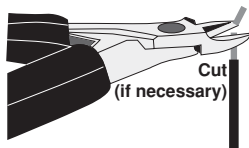

For Side Wire Stripping  
(measure bare wire here)

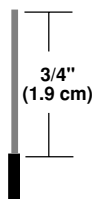

For Back Wire Stripping  
(measure bare wire here)

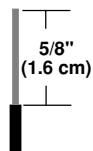

- Make sure that the ends of the wires from the wall box are **straight (cut if necessary)**.
- Remove insulation from each wire in the wall box as shown.

#### Step 3 Installing your Alignment Plate:



#### Important Notice for Installer

To achieve proper aesthetic installation of the Acenti products, the wall surface surrounding the wall box opening must be fairly flat and free of irregularities. The wall box must be level and recessed or flush to the wall surface. The Acenti installation system allows for adjustments that will correct minor flaws that may be present in the installation area.

This device must be installed with the Acenti™ Alignment Plate. The Alignment Plate is packaged with the Acenti™ Wallplate, which is sold separately from this device.

The Alignment Plate will function properly only if it is mounted to a flat wall surface as described above.

- Leviton recommends to temporarily position the Alignment Plate prior to wiring the device. If the wall box wires extend at least 6 inches out of the wall box, it is also possible to install the Alignment Plate after the device has been wired (**refer to Wallplate instruction sheet**).
- The Alignment Plate must be installed with the tab towards the bottom.
- Leviton recommends the following 3 methods to **temporarily** hold the Alignment Plate – use of device mounting screw, use of wall box wires, or use of electrical tape (**refer to the following figures**):

Alignment Plate Held  
By Mounting Screw

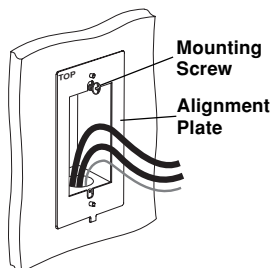

Alignment Plate  
Held By Wires

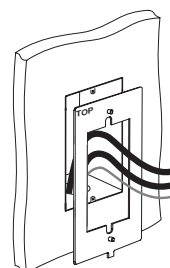

Alignment Plate  
Held By Tape

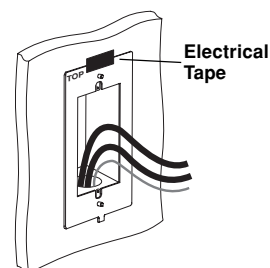

## Step 4 Installing your Receptacle – Single Feed Wiring Only:

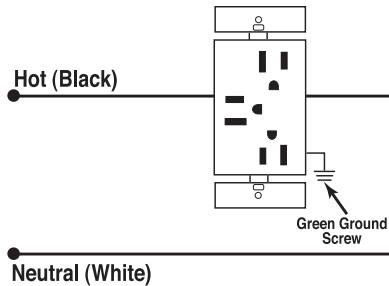
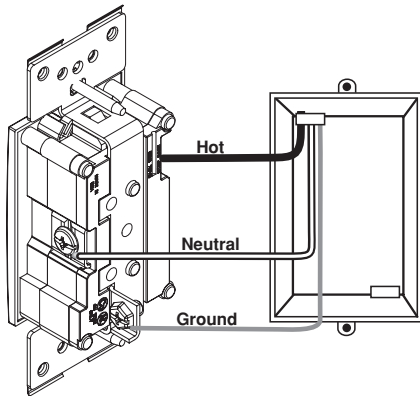

Connect wires per **WIRING DIAGRAM** as follows:

### TO SIDE WIRE:

**NOTE:** Side wire terminals accept up to #10 AWG wire.

- Loop wires clockwise 3/4 turn around terminal screws.
- Green or bare copper wall box wire (Ground) to Green screw.
- Black (Hot) wall box wire to Brass screw.
- White (Neutral) wall box wire to Silver screw.
- Tighten terminal screws to 14-16 in.-lbs. of torque.

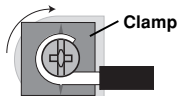

**Side Wire Connection**  
Side wire terminals accept up to #10 AWG wire.

- Tighten screws clockwise.

## Step 4 cont'd

### TO BACK WIRE:

**NOTE:** Back wire terminals accept up to #10 AWG wire.

- Insert straight wires under clamps with appropriate terminal screws.
- Loop Green or bare copper wall box wire (Ground) clockwise 3/4 turn around Green terminal screw.
- Black (Hot) wall box wire under clamp with Brass screw.
- White (Neutral) wall box wire under clamp with Silver screw.
- Tighten terminal screws to 14-16 in.-lbs. of torque.

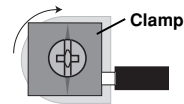

**Back Wire Connection**  
Back wire clamps accept up to #10 AWG wire.

- Tighten screws clockwise.

**NOTE:** The Acenti™ Triplex Receptacle uses a multi-function self-grounding clip that provides an automatic ground connection in a properly grounded metal wall box.

## Step 5 Receptacle Mounting:

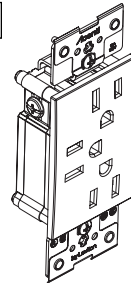

To complete the Acenti™ Receptacle and Wallplate installation, please refer to the instructions included with the Acenti™ Wallplate and Alignment Plate.

For additional information, contact the Acenti™ Information Hotline at 1-888-4-ACENTI or visit Leviton's website at [www.leviton.com/acenti](http://www.leviton.com/acenti)

U.S. & Foreign Patents Pending  
Copyright © 2004 Leviton Manufacturing Co., Inc.  
All Rights Including Trade Dress Rights Reserved

### LIMITED 5 YEAR WARRANTY AND EXCLUSIONS

Leviton warrants to the original consumer purchaser and not for the benefit of anyone else that this product at the time of its sale by Leviton is free of defects in materials and workmanship under normal and proper use for five years from the purchase date. Leviton's only obligation is to correct such defects by repair or replacement, at its option, if within such five year period the product is returned prepaid, with proof of purchase date, and a description of the problem to **Leviton Manufacturing Co., Inc., Att: Quality Assurance Department, 59-25 Little Neck Parkway, Little Neck, New York 11362-2591**. This warranty excludes and there is disclaimed liability for labor for removal of this product or reinstallation. This warranty is void if this product is installed improperly or in an improper environment, overloaded, misused, opened, abused, or altered in any manner, or is not used under normal operating conditions or not in accordance with any labels or instructions. **There are no other or implied warranties of any kind, including merchantability and fitness for a particular purpose**, but if any implied warranty is required by the applicable jurisdiction, the duration of any such implied warranty, including merchantability and fitness for a particular purpose, is limited to five years. **Leviton is not liable for incidental, indirect, special, or consequential damages, including without limitation, damage to, or loss of use of, any equipment, lost sales or profits or delay or failure to perform this warranty obligation.** The remedies provided herein are the exclusive remedies under this warranty, whether based on contract, tort or otherwise.

PK-93602-10-00-0A-X0