

**WARNINGS AND CAUTIONS:**

- To be installed and/or used in accordance with appropriate electrical codes and regulations.
- To avoid fire, shock or death, **TURN OFF POWER** at circuit breaker or fuse. Test that power is off before wiring.
- Use these devices only with copper or copper clad wire. With aluminum wire use only devices marked CO/ALR or CU/AL.
- **NOTE:** The following diagrams apply to both Standard Style and Decora Style Combination Devices.

**Standard Style Switch**  
Cat. No. 5224

Single pole →  
Single pole →

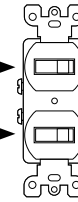

**Decora Style Switch**  
Cat. No. 5634

Single pole →  
Single pole →

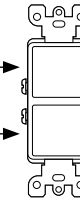

**Tools needed to install Switch:**

- Slotted, Phillips, or Robertson Screwdriver
- Wire Cutters

**INSTALLING SWITCH:**

**NOTE:** Use check boxes  when Steps are completed.

**Step 1** **WARNING:** To avoid fire, shock, or death; **TURN OFF POWER** at circuit breaker or fuse and test that power is off before wiring!

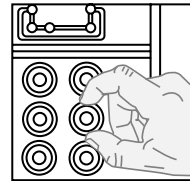
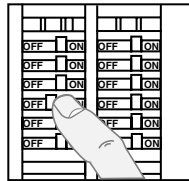

**Step 2** **Identify Wall Box Wiring:**



To install this combination switch, the following wires must be present inside wall box.

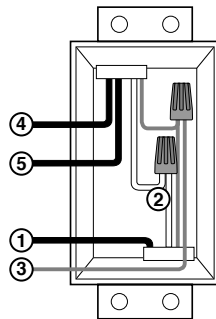

**SINGLE LINE HOT**  
**(Common Feed)**

1. Line (Hot-System)
2. Neutral (Optional)
3. Ground
4. Load - Single Pole 1
5. Load - Single Pole 2

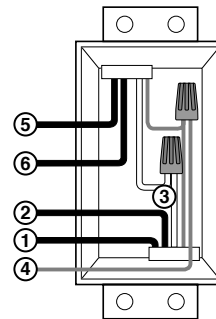

**TWO LINE HOT**  
**(Separate Feed)**

1. Line 1 (Hot-System)
2. Line 2 (Hot-System)
3. Neutral (Optional)
4. Ground
5. Load - Single Pole 1
6. Load - Single Pole 2

**NOTE:** Neutral and ground connections may differ in your application. Ensure the device is properly grounded to system. If the wiring in the wall box does not resemble any of these configurations, consult a qualified electrician.

**Step 3** **Prepare Wires:**



Remove 5/8" (1.6 cm) of insulation from each wire in the wall box.

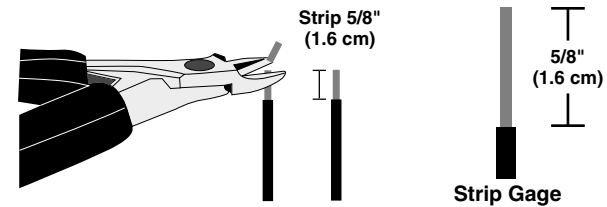

**NOTE:** For separate feed (2 circuit) operation only: The break-off fin located between the brass screws should be removed before wiring. Using a standard slotted screwdriver, bend fin until it breaks off.

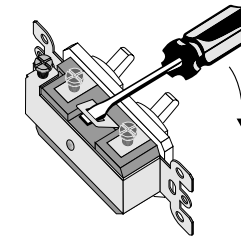

**Step 4** **Installing your Switch:**



**COMMON FEED (Single Line Hot)**

Two single pole switches on the same circuit. Each single pole switch controls independent light(s).

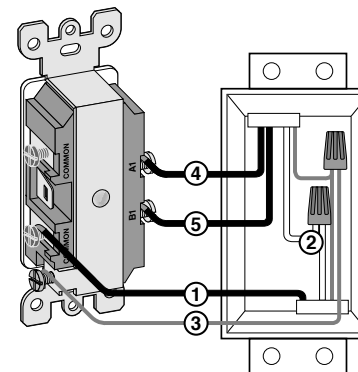

**SINGLE LINE HOT**  
**(Common Feed)**

1. Line (Hot-System)
2. Neutral (Optional)
3. Ground
4. Load - Single Pole 1
5. Load - Single Pole 2

**Step 4  
cont.**

**COMMON FEED (Single Line Hot)**

Cat. No. 5224

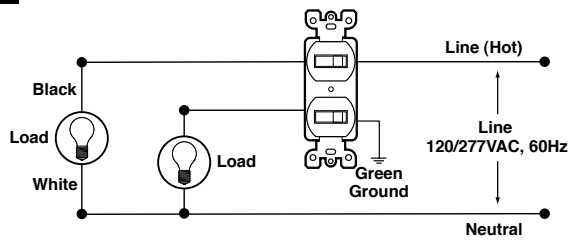

Connect wires per **WIRING DIAGRAM** as follows.

**NOTE:** For separate feed installations (TWO LINE HOT) proceed to **Step 4a**.

- Loop wires clockwise 3/4 turn around terminal screws.
  - Green or bare copper wall box wire (Ground) to Green screw.
  - Black wall box wire (LINE HOT) to either Brass screw (Common).
  - Black wall box wire (Load 1) to Brass screw (A1).
  - Black wall box wire (Load 2) to Brass screw (B1).
  - Tighten screws over wire loops with a force of 12-14 in.-lbs. of torque.
- Terminal screws accept up to #12 AWG copper or copper clad wire.

**Step 4a SEPARATE FEED (Two Line Hot)**



Two single pole switches on separate circuits. Each single pole switch controls an independent light. Break-off fin **removed**.

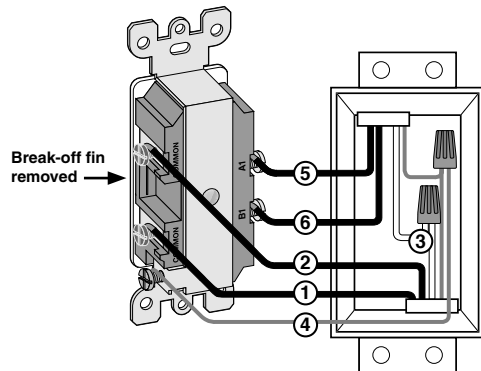

**TWO LINE HOT  
(Separate Feed)**

1. Line 1 (Hot-System)
2. Line 2 (Hot-System)
3. Neutral (Optional)
4. Ground
5. Load - Single Pole 1
6. Load - Single Pole 2

**Step 4a  
cont.**

**SEPARATE FEED (Two Line Hot)**

Cat. No. 5224

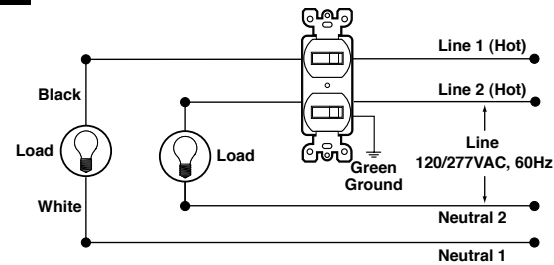

Connect wires per **WIRING DIAGRAM** as follows.

- Loop wires clockwise 3/4 turn around terminal screws.
  - Green or bare copper wall box wire (Ground) to Green screw.
  - Black wall box wire (LINE 1 - HOT) to Brass screw (Common).
  - Black wall box wire (LINE 2 - HOT) to remaining Brass screw (Common).
  - Black wall box wire (Load 1) to Brass screw (A1).
  - Black wall box wire (Load 2) to Brass screw (B1).
  - Tighten screws over wire loops with a force of 12-14 in.-lbs. of torque.
- Terminal screws accept up to #12 AWG copper or copper clad wire.

**Step 5 Complete Installation:**



- Carefully position all wires to provide room in wall box for switch. Mount switch into wall box with mounting screws supplied.
- Attach wallplate (sold separately) and restore power. **INSTALLATION IS COMPLETE.**

**Step 6 Test Installation:**



RESTORE POWER AT CIRCUIT BREAKER OR FUSE.

**FOR SINGLE POLE SWITCH (Top)**

- Operate top toggle (rocker) several times: Light(s) should turn on and off.

**FOR SINGLE POLE SWITCH (Bottom)**

- Operate bottom toggle (rocker) several times: Light(s) should turn on and off.

**NOTE:** If light(s) do not work properly, TURN OFF POWER and re-check wiring connections. If light(s) still do not work, consult a qualified electrician.

**Product Information**

- For technical assistance contact us at **1-800-824-3005**
- Visit our website at **www.leviton.com**

**LIMITED 2 YEAR WARRANTY AND EXCLUSIONS**

Leviton warrants to the original consumer purchaser and not for the benefit of anyone else that this product at the time of its sale by Leviton is free of defects in materials and workmanship under normal and proper use for two years from the purchase date. Leviton's only obligation is to correct such defects by repair or replacement, at its option, if within such two year period the product is returned prepaid, with proof of purchase date, and a description of the problem to **Leviton Manufacturing Co., Inc., Att: Quality Assurance Department, 59-25 Little Neck Parkway, Little Neck, New York 11362-2591**. This warranty excludes and there is disclaimed liability for labor for removal of this product or reinstallation. This warranty is void if this product is installed improperly or in an improper environment, overloaded, misused, opened, abused, or altered in any manner, or is not used under normal operating conditions or not in accordance with any labels or instructions. There are no other or implied warranties of any kind, including merchantability and fitness for a particular purpose, but if any implied warranty is required by the applicable jurisdiction, the duration of any such implied warranty, including merchantability and fitness for a particular purpose, is limited to two years. Leviton is not liable for incidental, indirect, special, or consequential damages, including without limitation, damage to, or loss of use of, any equipment, lost sales or profits or delay or failure to perform this warranty obligation. The remedies provided herein are the exclusive remedies under this warranty, whether based on contract, tort or otherwise.

**LEVITON INSTRUCTION SHEET/MANUAL SPECIFICATIONS**

- Artwork No/Rev Level: \_\_\_\_\_
- Color(s): Black over PK-93612-10-00-0A
- 1. \_\_\_\_\_ 2. \_\_\_\_\_
- 3. \_\_\_\_\_ 4. \_\_\_\_\_
- Font Families: Helvetica
- Material  
Type: 37 Lb. offset
- Coating:  \_\_\_\_\_
- Paper size:  
**Overall size:** 8.5" X 8"  
**Final fold size:** 1.7" X 4"

**DOCUMENTATION**

- ECO No.: N/A
- Artist: H2D Date: 08/06/04

The information in this document is the exclusive PROPRIETARY property of LEVITON MANUFACTURING COMPANY, INC. It is disclosed with the understanding that acceptance or review by the recipient constitutes an undertaking by the recipient, (1) to hold this information in strict confidence, and (2) not to disclose, duplicate, copy, modify, or use the information for any purpose other than that for which disclosed.

Copyright © 1997 Leviton Mfg. Co. Inc.  
Unpublished, All Rights Reserved

**FOLD SCHEME**

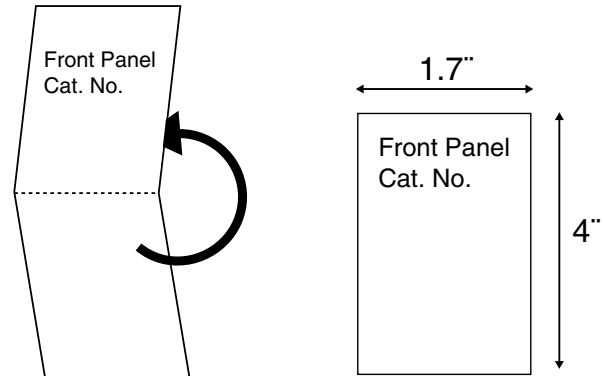
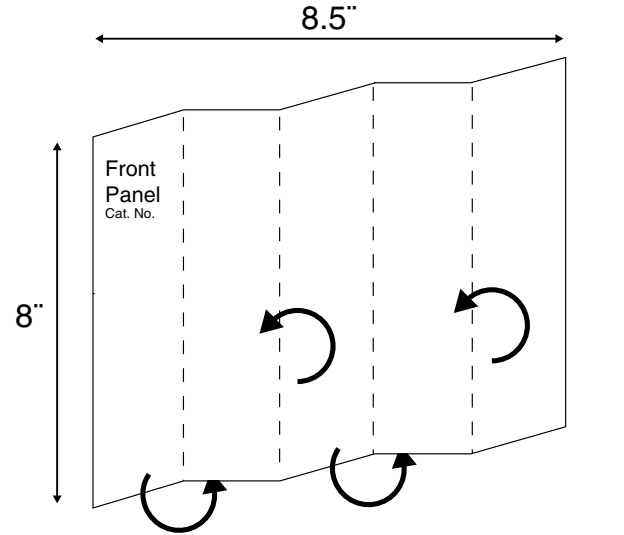

— — — Fold Line

..... Center Line