

2675

Brand Features

Leviton's industry leading locking devices, such as our Black & White line of industrial grade plugs and connectors and our V-0-Max line of industrial grade flush receptacles, offer superior performance, long lasting reliability and other features that are backed by a lifetime warranty.

Item Description

30 Amp, 250 Volt 3-Phase, NEMA L11-30P, 3P, 3W, Flanged Inlet Locking Receptacle, Industrial Grade, Non-Grounding - WHITE

Technical Information

AC Horsepower Ratings

At Rated Voltage: 3 HP

Electrical Specifications

Grounding: Non-Grounding

Amperage: 30 A

Voltage: 250 VAC

Pole: 3

Wire: 3

Dielectric Voltage: Withstands 2000V per UL498

Current Limiting: Full Rated Current

Temperature Rise: Max 30C after 250 cycles OL at 200 percent rated current

Phase: 3-Phase

Environmental Specifications

Flammability: Rated V-2 per UL 94

Operating Temperature: -40°C to 60°C

Environment: Dry

Material Specifications

Face Material: Nylon

Body Material: Nylon

Line Contacts: Solid Brass

Terminal Screws: Brass 10-32

Grounding Screw: Brass 8-32

Strap Material: Thermoplastic Nylon

Color: White

Mechanical Specifications

Terminal ID: Brass-Hot, Green-Ground, Silver-Neutral

Terminal Accom.: 18-10 AWG

Product ID: Ratings and NEMA I.D. permanently marked on device

Termination: Back

Product Features

NEMA: L11-30P

Color: White

Device Type: Locking Flanged Inlet

Brand: Black and White

Standards and Certifications

NEMA: WD-6

ANSI: C-73

UL498: File E13393

UL Fed Spec WC-596: File E13393

CSA C22.2 No. 42: File LR-406

NOM: 057

Warranty: Lifetime Warranty



Color: White

UPC Code: 07847780614

Country Of Origin: United States

NEMA:
L11-30P



Dimensional Diagram

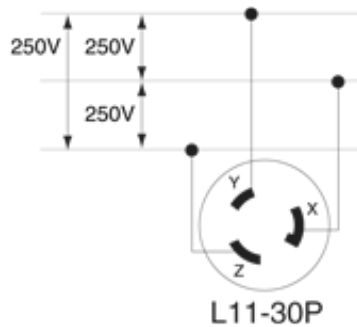
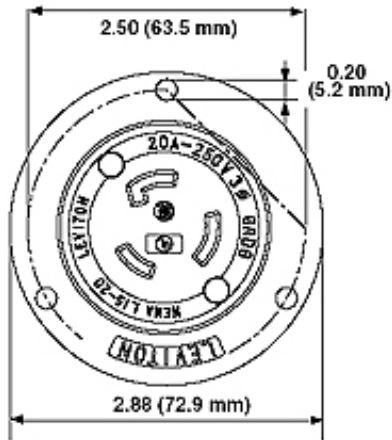

SPECIFICATION SUBMITTAL

JOB NAME: <input type="text"/>	CATALOG NUMBERS: <input type="text"/>	
JOB NUMBER: <input type="text"/>	<input type="text"/>	<input type="text"/>

Leviton Manufacturing Co., Inc.

201 North Service Road, Melville, NY 11747

Teléfono: +1-800-323-8920 · FAX: +1-800-832-9538 · Tech Line (8:30AM-7:30PM E.S.T. Monday-Friday): +1-800-824-3005

Leviton Manufacturing of Canada, Ltd.

165 Hymus Boulevard, Pointe Claire, Quebec H9R 1E9 · Telephone: +1-800-469-7890 ·

FAX: +1-800-824-3005 · www.leviton.com/canada

Leviton S. de R.L. de C.V.

Lago Tana 43, Mexico DF, Mexico CP 11290 · Tel.: (+52)55-5082-1040 · FAX: (+52)5386-

1797 · www.leviton.com.mx

Visit our Website at: www.leviton.com

© 2018 Leviton Manufacturing Co., Inc. Todos los derechos reservados. Subject to change without notice.

Leviton has a global presence.

If you would like to know where your local Leviton office is located please go to:

www.leviton.com/international/contacts/

