



Dry-Type Transformers



Converting Power Worldwide

Jefferson Electric Inc

Product Catalog JE901

Worldwide Products and Services

Tradition of Excellence

Jefferson Electric has been a pioneer and innovator of magnetic products since 1915. We enjoy a rich tradition of meeting the highest industry standards for quality, durability and reliability in the automotive, lighting, communications, transportation, commercial and industrial markets. We continue that tradition today in the contractor, industrial and OEM markets with a variety of new magnetic products.

Quality Products and Fast Delivery

The broad line of Jefferson Electric dry-type transformers is backed by quality assurance systems so stringent that every unit gets thoroughly tested before it goes out the door. This ensures one of the lowest return rates in the industry. All standard Jefferson Electric products conform to the appropriate UL, C-UL, CSA, and CE standards. Our extensive and strategically located inventory means you'll typically get U.S. delivery within 48 hours.



Adding Value

At Jefferson Electric, we are continually finding ways to add value in all we do. We're able to modify our transformer designs or add other components as part of our manufacturing process, thereby reducing your internal costs. For those truly unique applications, our engineering staff is available to create new transformer designs to your most exacting requirements. Our technical support engineers are available toll-free to help you size and select the right transformer and to answer field installation questions.

Visit our extensive website at www.JeffersonElectric.com.

Transformer Applications

Elevators



HVAC

Refrigeration-walk in coolers



Marine and Dock

Sign lighting-outdoor, billboard



Building lighting

Railroad cars

Pool and Spa



Landscape lighting

Fountain lights

Parking lights



Highway and street lighting

Factory

Manufacturing machinery

Computer Data Center



Table of Contents



Our Mission

Jefferson Electric will grow our business profitably to be the preferred supplier of diversified magnetic solutions to the electrical industry through worldwide distribution, OEMs and end users.

We will delight our customers by providing the highest levels of quality and service while surpassing the individual needs of our stakeholders: customers, associates, suppliers, sales representatives and investors.

Transformer Basics

How to Size and Select a Transformer	1.2
Custom Designs	1.7
Certifications	1.8

Products and Specifications

Single-Phase Encapsulated ...	2
Single-Phase Ventilated	3
Three-Phase Encapsulated ...	4
Three-Phase Ventilated	5
Three-Phase Ventilated – Special Voltages	6
Drive Isolation	7
Non-Linear	8
Buck-Boost – Powerformer®	9
Industrial Control	10
Lighting Transformers	11

Technical References

Installation	12.2
Protective Equipment	12.4
Insulation and Temperature ..	12.6
Transformer Sound	12.7
Troubleshooting Guide	12.8
Frequently Asked Questions ..	12.10
Glossary	12.13
Index and Warranty	13

Version JE901 0809 Date Sept 08

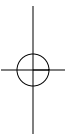
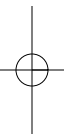


1-800-892-3755

www.jeffersonelectric.com

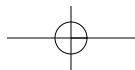
Dry-Type Transformers

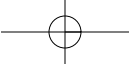
|



Version JE901 0809 Date Sept.08

II **Dry-Type Transformers** www.jeffersonelectric.com 1-800-892-3755





Transformer Basics

1



Contents

How to Size and Select a Transformer	1.2
Custom Designs	1.7
Certifications	1.8

Version JE901 0809 Date Sept 08

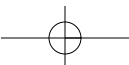


1-800-892-3755

www.jeffersonelectric.com

Dry-Type Transformers

1.1



1

Transformer Basics

How to Size and Select a Transformer

1. Go to “How to size a transformer” on page 1.3 to determine the proper KVA based on the required load voltage, line voltage and load current.

For an example let's use Load voltage = 480 volts, Load current, = 80 Amps and Line voltage = 208 volts. Using the calculation yields a 66 KVA transformer.

2. Go to “How to select a transformer” on page 1.6 and choose the appropriate style of transformer for the application from the listing.

For example if you need a transformer for a three phase industrial application you can choose the Three Phase Ventilated style.

3. Go to the appropriate section in the catalog.

For this example, section 5.

4. Go to the chapter and review the chapter table of contents and find the page for your voltage group.

For 208 volt primary to 480 volt secondary, 150 degree temperature rise units are on page 5.4.

5. On the Selection chart find the voltage group heading, **208 V- 480Y/277 – Aluminum windings**, and select a line with a KVA equal to or larger that the KVA you calculated for your application in the first column of the chart, **75 KVA**. Directly to the right is the catalog number for the transformer, **423-7231-000**. Check the rest of the information in the row for the dimensional information, shipping weight, **565 lbs**, wiring diagram number, **T208D**, and options such as weather shield, **423-7008-075**, and mounting brackets, **223-7008-075**.

Version JE901 0809 Date Sept.08

Transformer Basics

How to size a transformer

- Transformer size is determined by the KVA of the load.
- Load voltage, or secondary voltage, is the voltage needed to operate the load.
- Line voltage, or primary voltage, is the voltage from the source.
- Single-Phase has two lines of AC power.
- Three-Phase has three lines of AC power, each line 120 degrees out of phase with the other two.
- KVA is kilovolt ampere or thousand volt amperes. This is how transformers are rated.

NOTE: If motors are started more than once per hour, increase minimum transformer KVA by 20%.

To determine the size of the transformer you need, use this handy formula, or refer to the Technical Reference Section.

- Determine the Load Voltage**
Load Voltage = _____
- Determine the Load Current (Amps)**
Load Current/Amps = _____
- Determine the Line Voltage**
Line Voltage = _____

Determine if your application is single-phase or three-phase, and use the corresponding formula in the column at right.

The KVA of the transformer should be equal to or greater than the KVA of the load to handle present requirements and to account for future expansion.

Or, use our Product Specifier at www.JeffersonElectric.com for quick and easy transformer selection.

Transformer Selection Formulas

Single-Phase Transformers

$$\frac{\text{Volts} \times \text{Amps}}{1000} = \text{KVA}$$

Plug your numbers into the formula:

$$\frac{\text{Volts} \quad \times \text{Amps}}{1000} = \text{KVA}$$

Three-Phase Transformers

$$\frac{\text{Volts} \times \text{Amps} \times 1.732}{1000} = \text{KVA}$$

Plug your numbers into the formula:

$$\frac{\text{Volts} \quad \times \text{Amps} \quad \times 1.732}{1000} = \text{KVA}$$

Version JE901 0809 Date Sept 08



1

Transformer Basics

Full Load Currents (In Amperes) For Single-Phase Transformers Voltage (Line-to-Line)

KVA Rating	120 V	208 V	240 V	277 V	480 V	600 V
.050	.42	.24	.21	.18	.10	.08
.075	.63	.36	.31	.27	.16	.13
.100	.83	.48	.42	.36	.21	.17
.150	1.25	.72	.63	.54	.31	.25
.250	2.08	1.20	1.04	.90	.52	.42
.500	4.16	2.40	2.08	1.8	1.04	.83
.750	6.25	3.60	3.13	2.7	1.56	1.25
1	8.3	4.8	4.2	3.6	2.1	1.7
1.5	12.5	7.2	6.2	5.4	3.1	2.5
2	16.7	9.6	8.3	7.2	4.2	3.3
3	25	14.4	12.5	10.8	6.2	5.0
5	41.7	24	20.8	18.0	10.4	8.3
7.5	62.5	36.1	31.2	27	15.6	12.5
10	83.4	48	41.6	36	20.8	16.7
15	125	72	62.5	54	31.2	25
25	208	120	104	90	52	41.7
37.5	312	180	156	135	78	62.5
50	417	240	208	180	104	83.5
75	625	361	312	270	156	125
100	834	480	416	361	208	167
167	1396	805	698	602	349	279

Full Load Currents (In Amperes) For Three-Phase Transformers Voltage (Line-to-Line)

KVA Rating	208 V	240 V	480 V	600 V
3	8.3	7.2	3.6	2.9
6	16.6	14.4	7.2	5.8
9	25	21.6	10.8	8.7
15	41.6	36.0	18.0	14.4
30	83	72	36	29
45	125	108	54	43
75	208	180	90	72
112.5	312	270	135	108
150	416	360	180	144
225	625	542	271	217
300	830	720	360	290
500	1390	1200	600	480
750	2080	1800	900	720

For Other Single-Phase KVA Ratings or Voltages

$$\text{Amperes} = \frac{\text{KVA} \times 1000}{\text{Volts}}$$

For Other Three-Phase KVA Ratings or Voltages

$$\text{Amperes} = \frac{\text{KVA} \times 1000}{\text{Volts} \times 1.732}$$

Source: EASA Handbook

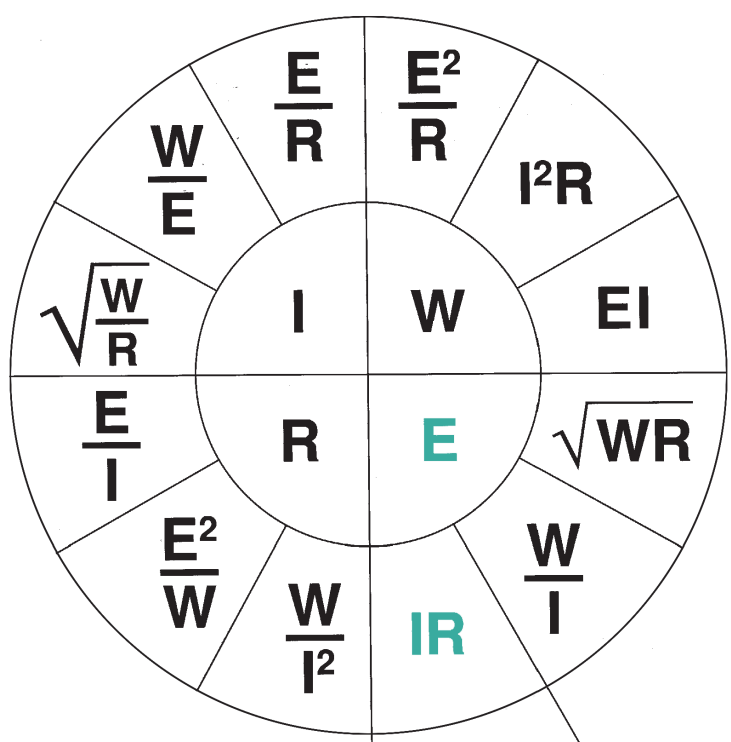
Version JJE901 0809 Date Sept.08



Transformer Basics

Single-Phase AC Motors Full Load Currents (Amperes)

HP	115 V	230 V
1/6	4.4	2.2
1/4	5.8	2.9
1/3	7.2	3.6
1/2	9.8	4.9
3/4	13.8	6.9
1	16	8
1 1/2	20	10
2	24	12
3	34	17
5	56	29
7 1/2	80	40
10	100	50



Sample of how to use this chart:
 $E = I \times R$
Electrical Relationships

Three-Phase AC Motors Full Load Currents (Amperes)

Rating	115 V	230 V	460 V	575 V
1/2	4	2	1	0.8
3/4	5.6	2.8	1.4	1.1
1	7.2	3.6	1.8	1.4
1 1/2	10.4	5.2	2.6	2.1
2	13.6	6.8	3.4	2.7
3		9.6	4.8	3.9
5		15.2	7.6	6.1
7 1/2		22	11	9
10		28	14	11
15		42	21	17
20		54	27	22
25		68	34	27
30		80	40	32
40		104	52	41
50		130	65	52
60		154	77	62
75		192	96	77
100		248	124	99
125		312	156	125
150		360	180	144
200		480	240	192

NOTE: If motors are started more than once per hour, increase minimum transformer KVA by 20%.

Version JE901 0809 Date Feb 09



1

Transformer Basics

How to Select a Transformer

Single Phase Encapsulated - 50 VA to 25 KVA - Section 2

For all general loads, indoors or out, including lighting, industrial and commercial applications. Units may be banked for three phase operation

Single Phase Ventilated – 15 to 100 KVA – Section 3

For all general single phase loads, indoors or out, including lighting, industrial and commercial applications

Three Phase Encapsulated – 3 to 75 KVA – Section 4

For all general three phase loads, indoors or out, including lighting, industrial and commercial applications

Three Phase Ventilated – 15 to 1000 KVA – Section 5 or 6

For all general three phase loads, indoors or out, including lighting, industrial and commercial applications.

Drive Isolation – 3 to 550 KVA – Section 7

For industrial and commercial applications with SCR-controlled adjustable speed motor drives, and AC adjustable frequency or DC drives

Non-Linear Three Phase – 15 to 500 KVA – Section 8

For electronic loads to meet non-linear load demands caused by modern office equipment
For indoor and outdoor applications

Buck-Boost – 50 VA to 10 KVA – Section 9

For correcting voltage line drops, landscape lighting, low voltage lighting, international voltage adaptation and motor applications. Buck-boost transformers do not compensate for fluctuating line voltages.

Industrial Control – 50 to 5000 VA, – Section 10

For control panels, conveyor systems, machine tooling equipment, commercial sewing machines, pumping system panels, and commercial air conditioning applications.

Landscape Lighting – 300 to 1800 watts – Section 11

For outdoor landscape lighting applications of 12 volt lamps.

Pool and Spa Lighting – 100 to 1000 watts – Section 11

For use with submersible fixtures including swimming pools, water fountains, low voltage circuits near water or other shock hazards. These transformers are not submersible.

Version JE901 0809 Date Sept.08

Transformer Basics

Custom Designs

Jefferson Electric's engineering team is available to work with you to produce the most efficient and cost effective solution for your specific transformer requirements. Depending on your needs, we offer both modified standards and unique designs.

Modified Standard Transformers

We can take our standard transformer designs and modify them to meet your needs including:

- modified enclosures
(shape, dimensions and color)
- input voltages and frequencies
(600V and below)
- output voltages
(adding more than one, 600V and below)

To request a quote on a modified standard, simply select the model that most closely matches your requirements, copy that page and fax it to us (800-942-5169), along with your desired modifications and estimated order volume. Visit our website for an on-line quote form.

Unique Designs

There are applications where a completely new transformer design is the only viable solution. Our experienced staff will design and produce the transformer that precisely matches your exact specifications, regulatory requirements and internal cost reduction goals.

If you have a dry type transformer requirement that requires a special design, please contact us (phone 800-892-3755 or fax 800-942-5169) to discuss your needs or fill out the "Get A Quote" section on our website www.jeffersonelectric.com.



1

Transformer Basics

Certification and safety requirement marks found on Jefferson products include:



Underwriters Laboratories Listing Mark

Samples of the product have met UL's safety requirements primarily based on UL's own published Standards of Safety.



UL Recognized Component Mark

This mark means that the *component alone* meets the requirements for a limited, specified use.



C-UL Listing Mark

Products with this type of mark have been evaluated to Canadian safety requirements by UL, which may be somewhat different than U.S. safety requirements.



CSA International Mark (formerly Canadian Standards Association)

This mark may appear alone, or with other qualifiers. If it appears alone, it means that the product is certified for the Canadian market, to the applicable Canadian standards.

Conformité Européene

To market electrical products within the European Union (EU), product conformity and the proper use of the CE mark on machines and control equipment is critical. As a major supplier to global companies serving customers in the EU, Jefferson Electric pays special attention to meeting the EU specification and certification requirements. These global companies need the guarantee of free trade of goods, elimination of trade restrictions and harmonization of technical regulations to sell their products to EU member countries. All Jefferson Electric products that meet or exceed the requirements of these directives are designated by the CE mark.

To request CE certified equivalents for products not already certified, please contact our Technical Support department at 800-892-3755.



ETL Intertek Verified

United States and Canada require general purpose transformers to meet specific energy efficiency standards. Jefferson Electric has contracted with Intertek ETL SEMKO an independent organization to test and certify our products. The ETL logo on our products indicates that the transformer meets the energy efficiency standards as defined by the NEMA TP-1 standard.



Version JE901 0809 Date Sept.08



Single-Phase Encapsulated

2



0.050 to 25 KVA

Contents

Overview	2.2
Dimensional Drawings	2.5
Wiring Diagrams	2.6
Selection Charts	
120/240 V - 120/240 V	2.3
208 V - 120/240 V	2.3
240/480 V - 120/240 V	2.3
277 V - 120/240 V	2.4
600 V - 120/240 V	2.4
International Voltages	2.4

Version JE901 0809 Date Sept 08



1-800-892-3755

www.jeffersonelectric.com

Dry-Type Transformers

2.1

2

Single-Phase Encapsulated

Products

- *General Purpose: 50 VA through 25 KVA**
- *International: 1 KVA through 25 KVA**

Applications

- *For all general loads, indoors or out, including lighting, industrial and commercial applications*
- *Units may be banked for 3-Phase operations*

Specifications

- *Encapsulated with electrical grade resin*
- *Cores of high quality electrical steel*
- *NEMA 3R-rated enclosures*
- *50/60 Hz operation as noted*
- *International units electrostatically shielded*
- *Heat-cured ASA-61 gray powder coat finish*

Features, Functions, Benefits

- *Large connection compartment with knockouts for ease of wiring and installation*
- *Quiet operation for installation flexibility*
- *Slotted mounting holes for quick and easy mounting*
- *Convenient wall mount design with lifting hooks above 5 KVA*
- *Permanently affixed wiring diagram*

Standards

- *Built in accordance with NEMA, ANSI, UL and CSA standards*
- *International units are CE Marked*

*Options and Accessories

- *CE Marked units available as custom*
- *Other sizes and voltages available as custom*

Version JE901 0809 Date Sept 08

Version JE901 0809 Date Sept 08

Single-Phase Encapsulated

General Purpose

.050 - 1 KVA, 95°C Temperature Rise; 1.5 - 25 KVA, 135°C Temperature Rise

KVA	Catalog Number	Fig.	Height A (in.)	Width B (in.)	Depth C (in.)	Wiring Diagram	Est. Ship Wgt. (lbs.)
120 X 240 V – 120/240 V 60 Hz • Taps None							
.500	411-0051-120	2	10.19	5.06	4.59	S240A	15
1	411-0071-120	2	10.19	5.06	4.59		19
2	411-0091-120	3	12.50	6.69	5.34		41
3	411-0101-120	3	14.56	7.56	7.15		68
5	411-0111-120	3	14.56	7.56	7.15		93
7.5	411-0131-120	4	16.12	13.50	8.55		130
10	411-0151-120	4	16.12	13.50	8.55		155
15	411-0161-120	4	21.12	16.50	10.06		255
25	411-0181-120	4	21.12	16.50	10.06		291
208 V – 120/240 V 60 Hz • Taps None							
.500	411-0051-208	2	10.19	5.06	4.59	S208A	15
1	411-0071-208	2	10.19	5.06	4.59		19
2	411-0091-208	3	12.50	6.69	5.34		41
3	411-0101-208	3	14.56	7.56	7.15		68
5	411-0111-208	3	14.56	7.56	7.15		93
7.5	411-0131-208	4	16.12	13.50	8.55		130
10	411-0151-208	4	16.12	13.50	8.55		155
15	411-0161-208	4	21.12	16.50	10.06		255
25	411-0181-208	4	21.12	16.50	10.06		291
240 X 480 V – 120/240 V 60 Hz • Taps None							
.050	411-0001-000	2	8.03	3.31	3.08	S480A	6
.100	411-0021-000	2	8.03	3.31	3.08		6
.150	411-0031-000	2	8.03	3.31	3.08		6
.250	411-0041-000	2	8.03	3.31	3.08		7
.500	411-0051-000	2	10.19	5.06	4.59		15
.750	411-0061-000	2	10.19	5.06	4.59		18
1	411-0071-000	2	10.19	5.06	4.59		19
1.5	411-0081-000	3	12.50	6.69	5.34		33
2	411-0091-000	3	12.50	6.69	5.34		41
3	411-0101-000	3	14.56	7.56	7.15		68
5	411-0111-000	3	14.56	7.56	7.15		93
7.5	411-0131-000	4	16.12	13.50	8.55		130
10	411-0151-000	4	16.12	13.50	8.55		155
15	411-0161-000	4	21.12	16.50	10.06		255
25	411-0181-000	4	21.12	16.50	10.06		291
240 x 480 V – 120/240 V 60 Hz • Taps: 2 – 2.5% FCAN + 2 – 2.5% FCBN							
3	411-0104-300	3	14.56	7.56	7.15	S480B	68
5	411-0114-300	3	14.56	7.56	7.15		93
7.5	411-0134-300	4	16.12	13.50	8.55		130
10	411-0154-300	4	16.12	13.50	8.55		155
15	411-0164-300	4	21.12	16.50	10.06		255
25	411-0184-300	4	21.12	16.50	10.06		291

Note: Housing dimensions subject to change without notice. Consult website or factory where dimensions are critical.



Version JE901 0809 Date Sept 08



1-800-892-3755

www.jeffersonelectric.com

Dry-Type Transformers

2

Single-Phase Encapsulated

General Purpose

.050 - 1 KVA, 95°C Temperature Rise; 1.5 - 25 KVA, 135°C Temperature Rise

KVA	Catalog Number	Fig.	Height A (in.)	Width B (in.)	Depth C (in.)	Wiring Diagram	Est. Ship Wgt. (lbs.)
277 V – 120/240 V 60 Hz • Taps: 2 – 2.5% FCBN							
.250	411-0041-277	2	8.03	3.31	3.08	S277A	6
.500	411-0051-277	2	10.19	5.06	4.59		15
1	411-0071-277	2	10.19	5.06	4.59		19
2	411-0091-277	3	12.50	6.69	5.34		41
3	411-0101-277	3	14.56	7.56	7.15		68
5	411-0111-277	3	14.56	7.56	7.15		93
7.5	411-0131-277	4	16.12	13.50	8.55		130
10	411-0151-277	4	16.12	13.50	8.55		155
15	411-0161-277	4	21.12	16.50	10.06		255
25	411-0181-277	4	21.12	16.50	10.06		291
600 V – 120/240 V 60 Hz • Taps: .050 - 1 KVA None, 1.5 – 25 KVA 4 – 2.5% FCBN							
.150	411-0036-000	2	8.03	3.31	3.08	S600A	6
.250	411-0046-000	2	8.03	3.31	3.08		7
.500	411-0056-000	2	10.19	5.06	4.59		15
.750	411-0066-000	2	10.19	5.06	4.59		18
1	411-0077-000	2	10.19	5.06	4.59	S600B	19
1.5	411-0087-000	3	12.50	6.69	5.34		33
2	411-0097-000	3	12.50	6.69	5.34		41
3	411-0107-000	3	14.56	7.56	7.15		68
5	411-0117-000	3	14.56	7.56	7.15		93
7.5	411-0137-000	4	16.12	13.50	8.55		130
10	411-0157-000	4	16.12	13.50	8.55		155
15	411-0167-000	4	21.12	16.50	10.06		255
25	411-0187-000	4	21.12	16.50	10.06		291



International

1 KVA, 130°C Insulation Class; 2.0 - 25 KVA, 180°C Insulation Class

KVA	Catalog Number	Fig.	Height A (in.)	Width B (in.)	Depth C (in.)	Wiring Diagram	Est. Ship Wgt. (lbs.)
190/200/208/220 x 380/400/416/440 V – 120/240 V 50/60 Hz Electrostatic Shielded							
1	511-0078-055	2	10.19	5.06	4.59	S440A	22
2	511-0098-055	3	12.50	6.69	5.34		44
3	511-0108-055	3	14.56	7.56	7.15		61
5	511-0118-055	3	14.56	7.56	7.15		96
7.5	511-0138-055	4	16.12	13.50	8.55		130
10	511-0158-055	4	16.12	13.50	8.55		155
15	511-0168-055	4	21.12	16.50	10.06		255
25	511-0188-055	4	21.12	16.50	10.06		291

Note: Housing dimensions subject to change without notice. Consult website or factory where dimensions are critical.



Version JE901 0809 Date Feb 09

Version JE901 0809 Date Sept 08

2.4

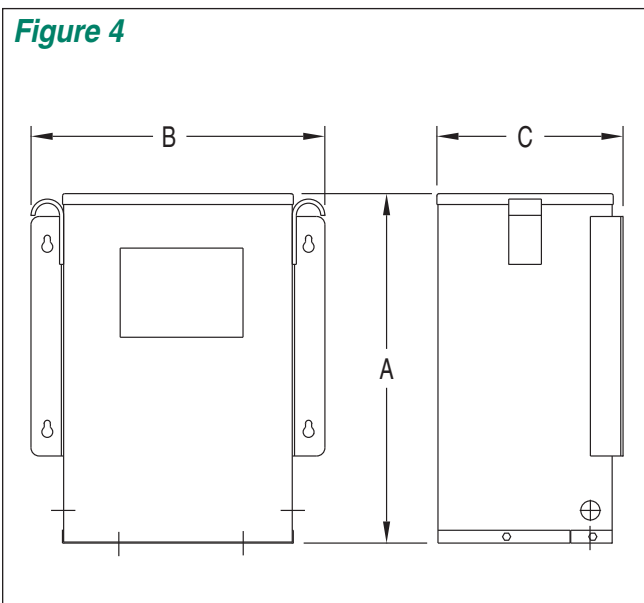
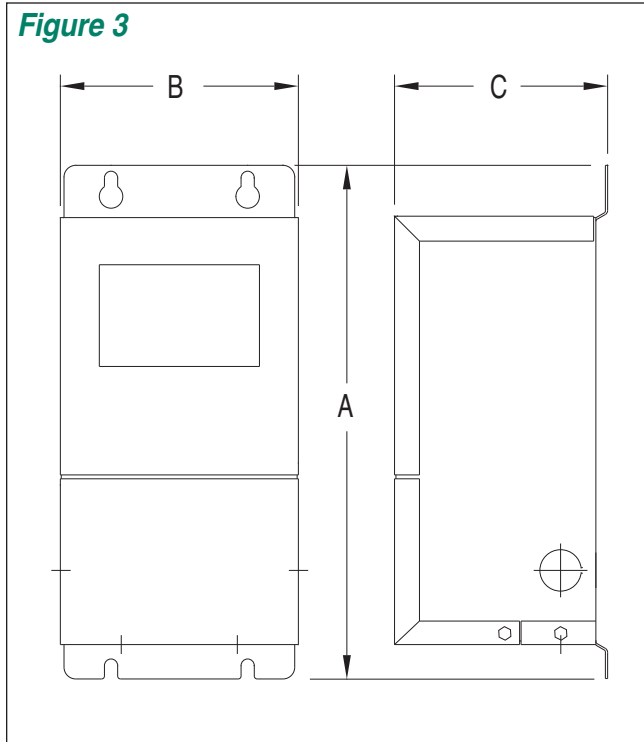
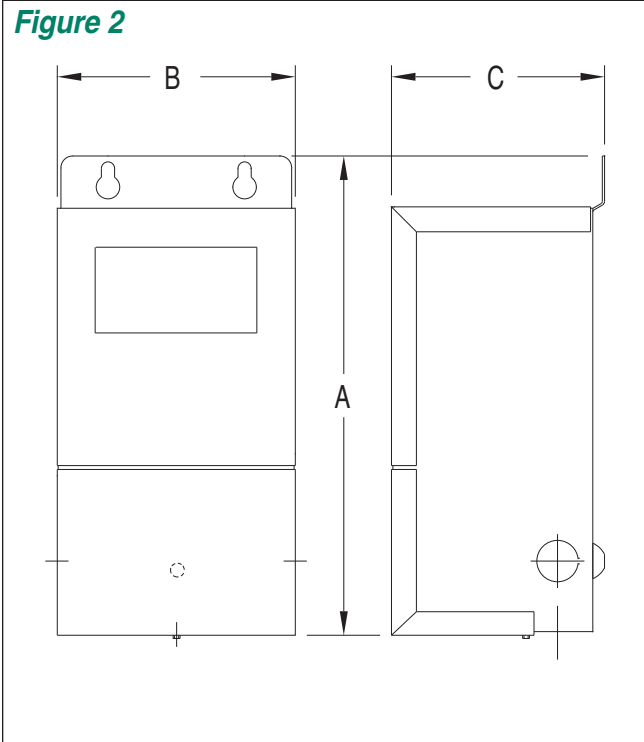
Dry-Type Transformers

www.jeffersonelectric.com

1-800-892-3755



Single-Phase Encapsulated



Version JE901 0809 Date Sept 08



1-800-892-3755

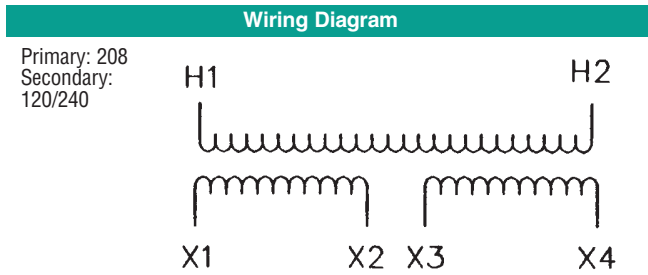
www.jeffersonelectric.com

Dry-Type Transformers

2.5

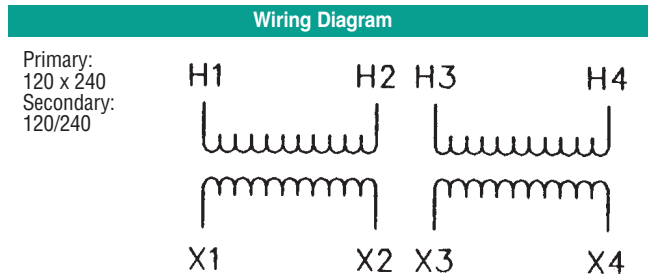
2 Single-Phase Encapsulated

S208A Wiring Diagram & Connections*



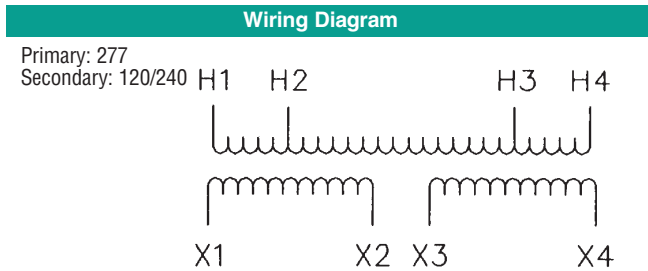
Connections		
Primary Volts	Primary Lines Connect To	
208	H1-H2	
Sec. Volts	Interconnect	Secondary Lines Connect To
240	X2 to X3	X1-X4
120/240	X2 to X3	X1-X2-X4
120	X1 to X3 X2 to X4	X1-X4

S240A Wiring Diagram & Connections*



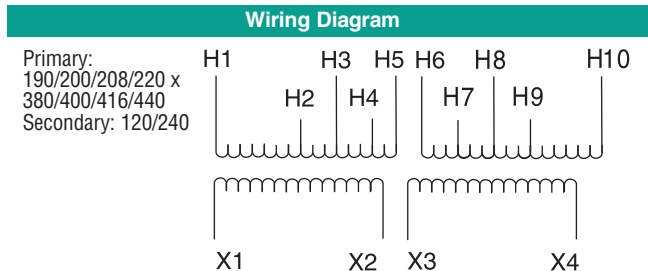
Connections		
Primary Volts	Interconnect	Primary Lines Connect To
240	H2 to H3	H1-H4
120	H1 to H3 H2 to H4	H1-H4
Sec. Volts	Interconnect	Secondary Lines Connect To
240	X2 to X3	X1-X4
120/240	X2 to X3	X1-X2-X4
120	X1 to X3 X2 to X4	X1-X4

S277A Wiring Diagram & Connections*



Connections		
Primary Volts	Primary Lines Connect To	
277	H1-H4	
270	H1-H3	
263	H2-H3	
Sec. Volts	Interconnect	Secondary Lines Connect To
240	X2 to X3	X1-X4
120/240	X2 to X3	X1-X2-X4
120	X1 to X3 X2 to X4	X1-X4

S440A Wiring Diagram & Connections*

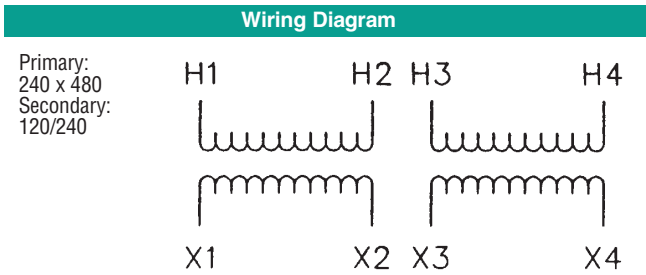


Connections		
Primary Volts	Interconnect	Primary Lines Connect To
440	H5 to H6	H1 and H10
416	H4 to H7	H1 and H10
400	H3 to H8	H1 and H10
380	H2 to H9	H1 and H10
220	H1 to H6 H5 to H10	H1 and H10
208	H1 to H7 H4 to H10	H1 and H10
200	H1 to H8 H3 to H10	H1 and H10
190	H1 to H9 H2 to H10	H1 and H10
Sec. Volts	Interconnect	Secondary Lines Connect To
240	X2 to X3	X1-X4
120/240	X2 to X3	X1-X2-X4
120	X1 to X3 X2 to X4	X1-X4

NOTE: Electrostatic shields are optionally available and not shown in all wiring diagrams. * Insulate unused taps individually.

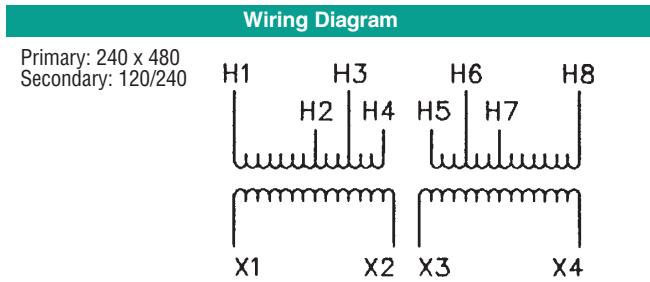
Single-Phase Encapsulated

S480A Wiring Diagram & Connections*



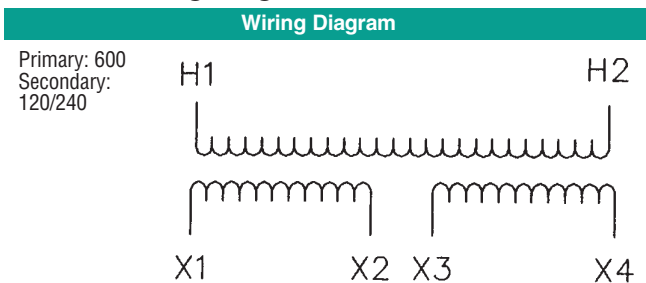
Connections		
Primary Volts	Interconnect	Primary Lines Connect To
480	H2 to H3	H1-H4
240	H1 to H3	H1-H4
	H2 to H4	
Sec. Volts	Interconnect	Secondary Lines Connect To
240	X2 to X3	X1-X4
120/240	X2 to X3	X1-X2-X4
120	X1 to X3	X1-X4
	X2 to X4	

S480B Wiring Diagram & Connections*



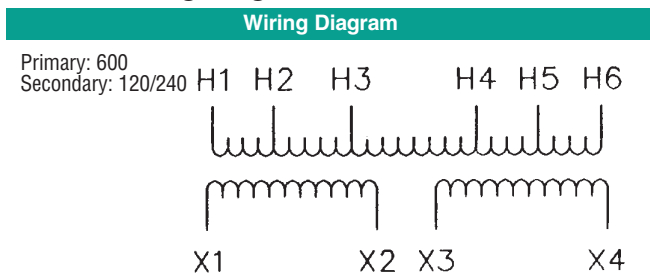
Connections		
Primary Volts	Interconnect	Primary Lines Connect To
504	H4 to H5	H1 and H8
492	H3 to H5	H1 and H8
480	H3 to H6	H1 and H8
468	H2 to H6	H1 and H8
456	H2 to H7	H1 and H8
252	H1 to H5	H1 and H8
	H4 to H8	
240	H1 to H6	H1 and H8
	H3 to H8	
228	H1 to H7	H1 and H8
	H2 to H8	
Sec. Volts	Interconnect	Secondary Lines Connect To
240	X2 to X3	X1 and X4
120/240	X2 to X3	X1-X2-X4
120	X1 to X3	X1-X4
	X2 to X4	

S600A Wiring Diagram & Connections*



Connections		
Primary Volts	Interconnect	Primary Lines Connect To
600		H1-H2
Sec. Volts	Interconnect	Secondary Lines Connect To
240	X2 to X3	X1-X4
120/240	X2 to X3	X1-X2-X4
120	X1 to X3	X1-X4
	X2 to X4	

S600B Wiring Diagram & Connections*



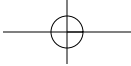
Connections		
Primary Volts	Interconnect	Primary Lines Connect To
600		H1-H6
585		H1-H5
570		H2-H5
555		H2-H4
540		H3-H4
Sec. Volts	Interconnect	Secondary Lines Connect To
240	X2 to X3	X1-X4
120/240	X2 to X3	X1-X2-X4
120	X1 to X3	X1-X4
	X2 to X4	

NOTE: Electrostatic shields are optionally available and not shown in all wiring diagrams. * Insulate unused taps individually.



1-800-892-3755 www.jeffersonelectric.com

Dry-Type Transformers

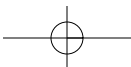


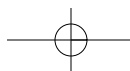
2

Single-Phase Encapsulated

Notes:

Version JE901 0809 Date Sepy 08





Single-Phase Ventilated

3



15 to 100 KVA

Contents

Overview	3.2
Dimensional Drawings	3.4
Wiring Diagrams	3.6
Selection Charts	
208 V - 120/240 V	3.3
240/480 V - 120/240 V	3.3
600 V - 120/240 V	3.3
Suffix Chart	3.4

Version JE901.0809 Date Sept.08

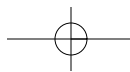


1-800-892-3755

www.jeffersonelectric.com

Dry-Type Transformers

3.1



3

Single-Phase Ventilated

Products

- *General Purpose: 15 KVA through 100 KVA*

Applications

- *For all general loads, indoors or out, including lighting, industrial and commercial applications*

Specifications

- *Cores of high quality electrical steel*
- *Meets Federally Mandated NEMA TP-1 Standard for energy efficiency*
- *NEMA 1 rated enclosures standard*
- *Electrostatic shields optional*
- *60 Hz operation*
- *Aluminum or copper windings*
- *Taps provided on primary*
- *220°C insulation class standard*
- *150°C, 115°C, and 80°C temperature rise*
- *Heat-cured ASA-61 gray powder coat finish*

Features, Functions, Benefits

- *Large connection compartment for ease of wiring and installation*
- *Quiet operation for installation flexibility*

Standards

- *Built in accordance with NEMA, ANSI, UL and CSA standards*

*Options and Accessories

- *Other sizes, voltages and temperature rises available*
- *CE Marked units available as custom*
- *Wall mount brackets available for units up to 75 KVA with 150°C temperature rise*
- *NEMA 3R-rated enclosure available with weather shields*

Version JE901 0809 Date Sept 08

Single-Phase Ventilated

General Purpose 150°C Temperature Rise

KVA	Catalog Number*	Fig.	Height A (in.)	Width B (in.)	Depth C (in.)	Est. Ship Wgt. (lbs.)	Wiring Diagram	Weather Shield Kit	Wall Bracket Kit
208 V - 120/240 V – Aluminum Windings • Taps: 15 to 37.5 kVA: 2@ 2.5% FCAN & 4@ 2.5% FCBN 50 to 100 kVA: 1@ 5% FCAN & 1@ 5% FCBN									
15	421-7162-000	7	27.0	15.0	15.0	190	S208B	421-0007-015	223-7008-030
25	421-7182-000	7	29.0	17.0	17.0	265		421-0007-017	223-7008-075
37.5	421-7202-000	7	31.0	20.0	18.0	330		421-0007-020	
50	421-7222-000	7	32.0	22.0	20.0	405	S208C	421-0007-022	N/A
75	421-7232-000	7	34.0	22.0	22.0	535		421-0007-022	
100	421-7242-000	7	36.0	22.0	24.0	690		421-0007-022	N/A

240 x 480 V - 120/240 V – Aluminum Windings • Taps: 15 to 100 kVA: 2@ 2.5% FCAN & 4@ 2.5% FCBN									
15	421-7165-000	7	27.0	15.0	15.0	190	S480F	421-0007-015	223-7008-030
25	421-7185-000	7	29.0	17.0	17.0	265		421-0007-017	223-7008-075
37.5	421-7205-000	7	31.0	20.0	18.0	330		421-0007-020	
50	421-7225-000	7	32.0	22.0	20.0	405		421-0007-022	
75	421-7235-000	7	34.0	22.0	22.0	535		421-0007-022	N/A
100	421-7245-000	7	36.0	22.0	24.0	690	421-0007-022	N/A	

600 V - 120/240 V – Aluminum Windings • Taps: 15 to 100 kVA: 4@ 2.5% FCBN									
15	421-7168-000	7	27.0	15.0	15.0	190	S600D	421-0007-015	223-7008-030
25	421-7188-000	7	29.0	17.0	17.0	265		421-0007-017	223-7008-075
37.5	421-7208-000	7	31.0	20.0	18.0	330		421-0007-020	
50	421-7228-000	7	32.0	22.0	20.0	405		421-0007-022	
75	421-7238-000	7	34.0	22.0	22.0	535		421-0007-022	N/A
100	421-7248-000	7	36.0	22.0	24.0	690		421-0007-022	N/A

* For units with an electrostatic shield, copper windings, and/or low temp rise requirements see suffix chart on page 3.4

Note: Housing dimensions subject to change without notice. Consult website or factory where dimensions are critical.



Version JE901 0809 Date Feb 09



1-800-892-3755 www.jeffersonelectric.com

Dry-Type Transformers

3.3

3

Single-Phase Ventilated

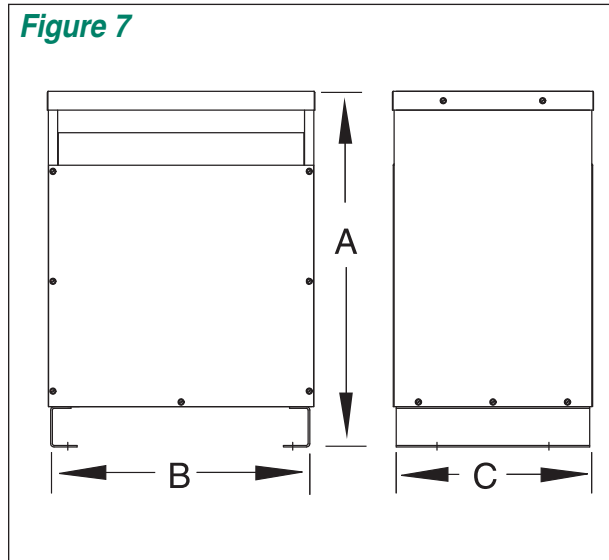
Suffix Chart

The catalog number on the standard product has a suffix of -000

To order alternate version transformers choose the suffix to match the desired features.

Suffix	Wire	Temperature Rise	Electrostatic Shield
000	Aluminum	150	no shield
005	Aluminum	150	shield
010	Aluminum	115	no shield
015	Aluminum	115	shield
080	Aluminum	80	no shield
085	Aluminum	80	shield
800	Copper	150	no shield
805	Copper	150	shield
810	Copper	115	no shield
815	Copper	115	shield
880	Copper	80	no shield
885	Copper	80	shield

Figure 7



Note: The weight, dimensions, weather shield and mounting brackets may be different than the standard (-000) version.

Check our website www.jeffersonelectric.com for details

Weathershields Kit to Make Enclosures NEMA 3R Rated

kVA*	Part Number	Width (B)	Depth w/o weather shield (C)	Depth with weather shield (3R-C)	Shipping weight (lbs.)
15	421-0007-015	15.0	15.0	22.0	2.6
25	421-0007-017	17.0	17.0	24.0	2.9
37.5	421-7007-020	20.0	18.0	25.0	3.3
50	421-7007-022	22.0	20.0	27.0	3.6
75	421-7007-022	22.0	22.0	29.0	4.2
100	421-7007-022	22.0	24.0	31.0	4.2

*kVA for 150 degree rise temp units, low temp units may use next larger weathershield

Mounting Brackets

Part Number	Description	Shipping weight (lbs.)
223-7008-030	For 15 kVA unit at 150 degree C rise	18
223-7008-075	For 16 to 50 kVA at 150 degree C rise	20

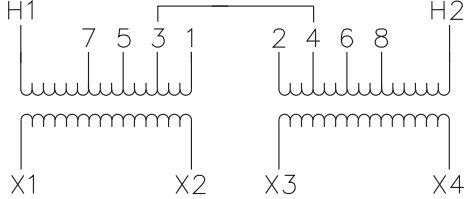
NOTE: Electrostatic shields are optionally available and not shown in all wiring diagrams. * Insulate unused taps individually.

Single-Phase Ventilated

S208B Wiring Diagram & Connections*

Wiring Diagram

Primary: 208
Secondary: 120/240

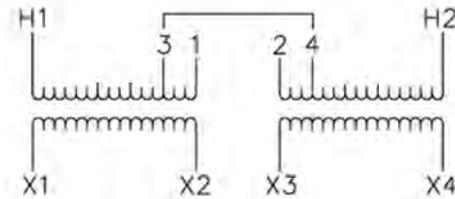


Connections		
Primary Volts	Interconnect	Primary Lines Connect To
218	1 and 2	H1 - H2
213	2 and 3	H1 - H2
208	3 and 4	H1 - H2
203	4 and 5	H1 - H2
198	5 and 6	H1 - H2
192	6 and 7	H1 - H2
187	7 and 8	H1 - H2
Secondary Volts	Interconnect	Secondary lines Connect to
240	X2 to X3	X1 - X4
120/240	X2 to X3	X1 - X2 - X4
120	X1 to X3 X2 to X4	X1 - X4

S208C Wiring Diagram & Connections*

Wiring Diagram

Primary: 208
Secondary: 120/240

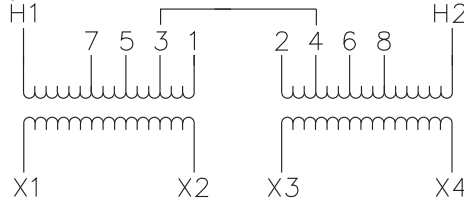


Connections		
Primary Volts	Jumper Taps To	Primary Lines Connect To
218	1 and 2	H1 - H2
208	2 and 3	H1 - H2
198	3 and 4	H1 - H2
Sec. Volts	Interconnect	Secondary Lines Connect To
240	X2 to X3	X1 - X4
120/240	X2 to X3	X1 - X2 - X4
120	X1 to X3 X2 to X4	X1 - X4

S480F Wiring Diagram & Connections*

Wiring Diagram

Primary: 240 x 480
Secondary: 120/240

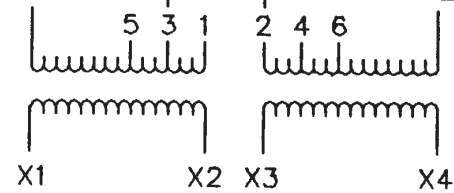


Connections			
Primary Volts	Jumpers Between Taps Left Coil	Right Coil	Primary Lines Connect To
504	1	2	H1 - H2
492	3	2	H1 - H2
480	3	4	H1 - H2
468	5	4	H1 - H2
456	5	6	H1 - H2
444	7	6	H1 - H2
432	7	8	H1 - H2
252	H2 - 1	H1 - 2	H1 - H2
240	H2 - 3	H1 - 4	H1 - H2
228	H2 - 5	H1 - 6	H1 - H2
216	H2 - 7	H1 - 8	H1 - H2
Secondary Volts	Interconnect	Secondary lines Connect to	
240	X2 to X3	X1 - X4	
120/240	X2 to X3	X1 - X2 - X4	
120	X1 to X3 X2 to X4	X1 - X4	

S600D Wiring Diagram & Connections*

Wiring Diagram

Primary: 600
Secondary: 120/240



Connections		
Primary Volts	Interconnect	Primary Lines Connect To
600	1 and 2	H1-H2
585	2 and 3	H1-H2
570	3 and 4	H1-H2
555	4 and 5	H1-H2
540	5 and 6	H1-H2
Sec. Volts	Interconnect	Secondary Lines Connect To
240	X2 to X3	X1-X4
120/240	X2 to X3	X1-X2-X4
120	X1 to X3 X2 to X4	X1-X4

NOTE:
Electrostatic shields are optionally available and not shown in all wiring diagrams. * Insulate unused taps individually.

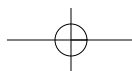
Version JE901 0612 Date Dec 06



1-800-892-3755 www.jeffersonelectric.com

Dry-Type Transformers

3.5

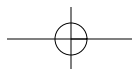


3

Single-Phase Ventilated

Notes:

Version JE901 0612 Date Dec 06



Three-Phase Encapsulated

4



3 to 75 KVA

Contents

Overview	4.2
Dimensional Drawings	4.5
Wiring Diagrams	4.5
Open Delta	4.8
Selection Charts	
208 V - 208Y/120 V	4.3
208 V - 480Y/277 V	4.3
240 V - 208Y/120 V	4.3
240 V - 480Y/277 V	4.3
480 V - 208Y/120 V	4.3
480 V - 240 V	4.3
480 V - 480Y/277 V	4.4
600 V - 208Y/120 V	4.4
600 V - 240 V	4.4
Suffix Chart	4.4

Version JE901 0809 Date Sept 08



1-800-892-3755

www.jeffersonelectric.com

Dry-Type Transformers

4.1

4

Three-Phase Encapsulated

Products

- *General Purpose: 3 KVA through 75 KVA**

Applications

- *For all general loads in rugged environments including refineries, factories, chemical plants, marine duty, ship docks, and grain mills*

Specifications

- *Encapsulated with electrical grade resin*
- *Cores of high quality electrical steel*
- *NEMA 3R-rated enclosures*
- *60 Hz operation*
- *180°C insulation class standard*
- *Heat-cured ASA-61 gray powder coat finish*

Features, Functions, Benefits

- *Large connection compartment with knockouts for ease of wiring and installation*
- *Quiet operation for installation flexibility*
- *Slotted mounting holes for quick and easy mounting*
- *Convenient wall mount design with lifting hooks – 3 to 15 KVA*
- *30 to 75 KVA floor mount design*
- *Permanently affixed wiring diagram*

Standards

- *Built in accordance with NEMA, ANSI, UL and CSA standards*

*Options and Accessories

- *CE Marked units available as custom*
- *Other sizes and voltages available as custom*

Version JE901 0809 Date Sept 08

Version JE901 0809 Date Feb 09

Three-Phase Encapsulated

General Purpose
 Three-Phase • 600V Class • Standard Application Voltages • Encapsulated
 Taps: 2 – 5% FCBN • 135°C Temperature Rise with 25° Ambient

KVA	Catalog Number	Fig.	Height A (in.)	Width B (in.)	Depth C (in.)	Wiring Diagram	Est. Ship Wgt. (lbs.)
208 Volts - 208Y/120 Volts							
3	413-1108-000	4	13.12	15.12	8.06	T208H	110
6	413-1128-000	4	13.12	15.12	8.06		140
9	413-1148-000	4	15.12	19	9.06		190
15	413-1168-000	4	15.12	19	9.06		245
30	413-1198-000	21	37	25	12.5		890
45	413-1218-000	21	37	25	12.5		790
75	413-1238-000	21	37	25	12.5		1050
208 Volts - 480Y/277 Volts							
3	413-1101-000	4	13.12	15.12	8.06	T208A	110
6	413-1121-000	4	13.12	15.12	8.06		140
9	413-1141-000	4	15.12	19	9.06		190
15	413-1161-000	4	15.12	19	9.06		245
30	413-1191-000	21	37	25	12.5		890
45	413-1211-000	21	37	25	12.5		790
75	413-1231-000	21	37	25	12.5		1050
240 Volts - 208Y/120 Volts							
3	413-1102-000	4	13.12	15.12	8.06	T240A	110
6	413-1122-000	4	13.12	15.12	8.06		140
9	413-1142-000	4	15.12	19	9.06		190
15	413-1162-000	4	15.12	19	9.06		245
30	413-1192-000	21	37	25	12.5		890
45	413-1212-000	21	37	25	12.5		790
75	413-1232-000	21	37	25	12.5		1050
240 Volts - 480Y/277 Volts							
3	413-1103-000	4	13.12	15.12	8.06	T240G	110
6	413-1123-000	4	13.12	15.12	8.06		140
9	413-1143-000	4	15.12	19	9.06		190
15	413-1163-000	4	15.12	19	9.06		245
30	413-1193-000	21	37	25	12.5		890
45	413-1213-000	21	37	25	12.5		790
75	413-1233-000	21	37	25	12.5		1050
480 Volts - 208Y/120 Volts							
3	413-1104-000	4	13.12	15.12	8.06	T480A	110
6	413-1124-000	4	13.12	15.12	8.06		140
9	413-1144-000	4	15.12	19	9.06		190
15	413-1164-000	4	15.12	19	9.06		245
30	413-1194-000	21	37	25	12.5		890
45	413-1214-000	21	37	25	12.5		790
75	413-1234-000	21	37	25	12.5		1050
480 Volts - 240 Volts							
3	413-1107-000	4	13.12	15.12	8.06	T480B	110
6	413-1127-000	4	13.12	15.12	8.06		140
9	413-1147-000	4	15.12	19	9.06		190
15	413-1167-000	4	15.12	19	9.06		245
30	413-1197-000	21	37	25	12.5		890
45	413-1217-000	21	37	25	12.5		790
75	413-1237-000	21	37	25	12.5		1050

* For units with an electrostatic shield, copper windings, and/or low temp rise requirements see suffix chart on page 4.4



Version JE901 0809 Date Feb 09

Note: Housing dimensions subject to change without notice. Consult website or factory where dimensions are critical.



1-800-892-3755 www.jeffersonelectric.com **Dry-Type Transformers**

4

Three-Phase Encapsulated

General Purpose

Three-Phase • 600V Class • Standard Application Voltages • Encapsulated
Taps: 2 – 5% FCBN • 135°C Temperature Rise with 25° Ambient

KVA	Catalog Number	Fig.	Height A (in.)	Width B (in.)	Depth C (in.)	Wiring Diagram	Est. Ship Wgt. (lbs.)
480 Volts - 480Y/277 Volts							
3	413-1105-000	4	13.12	15.12	8.06	T480C	110
6	413-1125-000	4	13.12	15.12	8.06		140
9	413-1145-000	4	15.12	19	9.06		190
15	413-1165-000	4	15.12	19	9.06		245
30	413-1195-000	21	37	25	12.5		890
45	413-1215-000	21	37	25	12.5		790
75	413-1235-000	21	37	25	12.5		1050
600 Volts - 208Y/120 Volts							
3	413-1109-000	4	13.12	15.12	8.06	T600A	110
6	413-1129-000	4	13.12	15.12	8.06		140
9	413-1149-000	4	15.12	19	9.06		190
15	413-1169-000	4	15.12	19	9.06		245
30	413-1199-000	21	37	25	12.5		890
45	413-1219-000	21	37	25	12.5		790
75	413-1239-000	21	37	25	12.5		1050
600 Volts - 240 Volts							
3	413-110A-000	4	13.12	15.12	8.06	T600E	110
6	413-112A-000	4	13.12	15.12	8.06		140
9	413-114A-000	4	15.12	19	9.06		190
15	413-116A-000	4	15.12	19	9.06		245
30	413-119A-000	21	37	25	12.5		890
45	413-121A-000	21	37	25	12.5		790
75	413-123A-000	21	37	25	12.5		1050

* For units with an electrostatic shield, copper windings, and/or low temp rise requirements see suffix chart on page 4.4



Suffix Chart

The catalog number on the standard product has a suffix of -000

To order alternate version transformers choose the suffix to match the desired features.

Suffix	Temperature Rise	Electrostatic Shield
000	135	no shield
005	135	shield
090	95	no shield
095	95	shield
070	70	no shield
075	70	shield

Note: The weight, dimensions, weather shield and mounting brackets may be different than the standard (-000) version.

Check our website www.jeffersonelectric.com for details

Floor Mount (Fig 21)



NOTE: Electrostatic shields are optionally available and not shown in all wiring diagrams. * Insulate unused taps individually.



Three-Phase Encapsulated

Figure 4

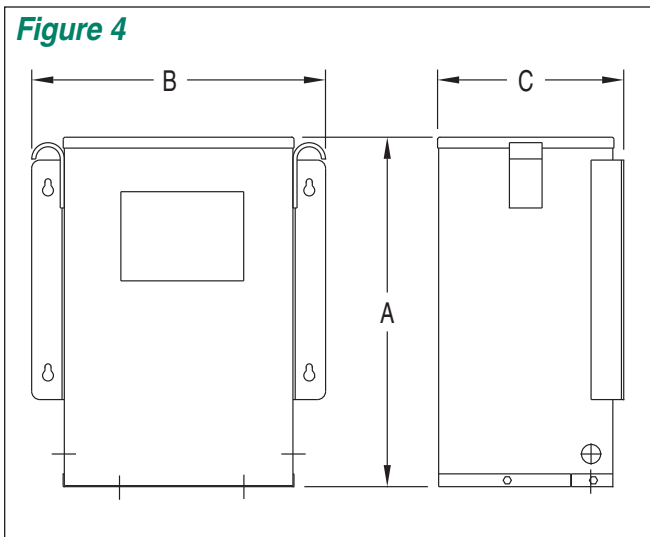
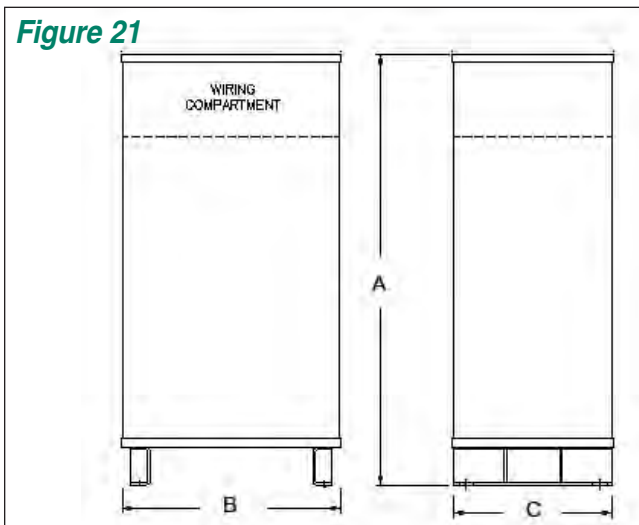


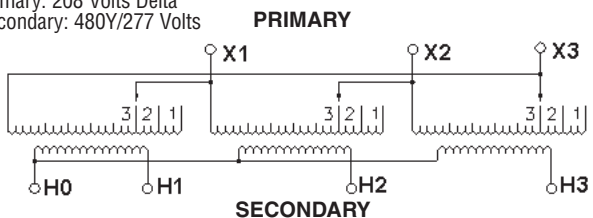
Figure 21



T208A Wiring Diagram & Connections*

Wiring Diagram

Primary: 208 Volts Delta
Secondary: 480Y/277 Volts



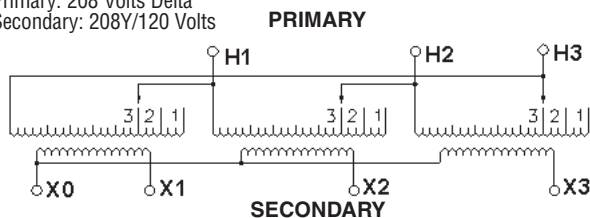
Connections

Primary Volts	Jumper Taps To	Primary Lines Connect To
208	1	X1, X2, X3
198	2	X1, X2, X3
187	3	X1, X2, X3
Sec. Volts	Secondary Lines Connect To	
480	H1, H2, H3	
277	Between H0 and H1 or H2 or H3	
1 Phase		

T208H Wiring Diagram & Connections*

Wiring Diagram

Primary: 208 Volts Delta
Secondary: 208Y/120 Volts



Connections

Primary Volts	Jumper Taps To	Primary Lines Connect To
208	1	H1, H2, H3
198	2	H1, H2, H3
187	3	H1, H2, H3
Sec. Volts	Secondary Lines Connect To	
208	X1, X2, X3	
120	Between X0 and X1 or X2 or X3	
1 Phase		

NOTE: Electrostatic shields are optionally available and not shown in all wiring diagrams. * Insulate unused taps individually.

Version JE901 0809 Date Sept 08



1-800-892-3755 www.jeffersonelectric.com

Dry-Type Transformers

4.5

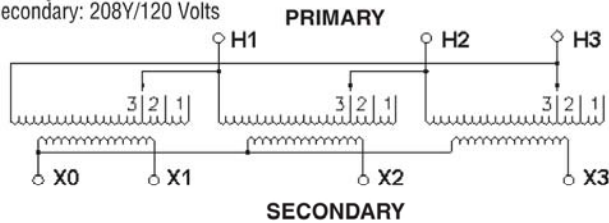
4

Three-Phase Encapsulated

T240A Wiring Diagram & Connections*

Wiring Diagram

Primary: 240 Volts Delta
Secondary: 208Y/120 Volts

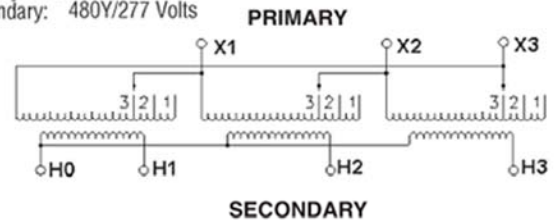


Connections		
Primary Volts	Jumper Taps To	Primary Lines Connect To
240	1	H1, H2, H3
228	2	H1, H2, H3
216	3	H1, H2, H3
Sec. Volts	Secondary Lines Connect To	
208	X1, X2, X3	
120	Between X0 and X1 or X2 or X3	
1 phase		

T240G Wiring Diagram & Connections*

Wiring Diagram

Primary: 240 Volts Delta
Secondary: 480Y/277 Volts

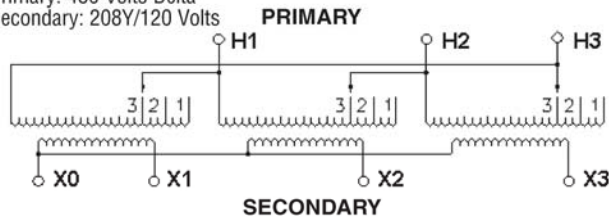


Connections		
Primary Volts	Jumper Taps To	Primary Lines Connect To
240	1	X1, X2, X3
228	2	X1, X2, X3
216	3	X1, X2, X3
Sec. Volts	Secondary Lines Connect To	
480	H1, H2, H3	
277	Between H0 and H1 or H2 or H3	
1 Phase		

T480A Wiring Diagram & Connections*

Wiring Diagram

Primary: 480 Volts Delta
Secondary: 208Y/120 Volts

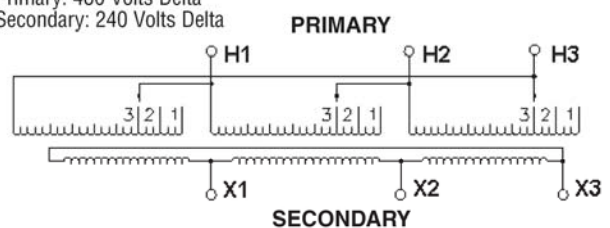


Connections		
Primary Volts	Jumper Taps To	Primary Lines Connect To
480	1	H1, H2, H3
456	2	H1, H2, H3
432	3	H1, H2, H3
Sec. Volts	Secondary Lines Connect To	
208	X1, X2, X3	
120	Between X0 and X1 or X2 or X3	
1 phase		

T480B Wiring Diagram & Connections*

Wiring Diagram

Primary: 480 Volts Delta
Secondary: 240 Volts Delta

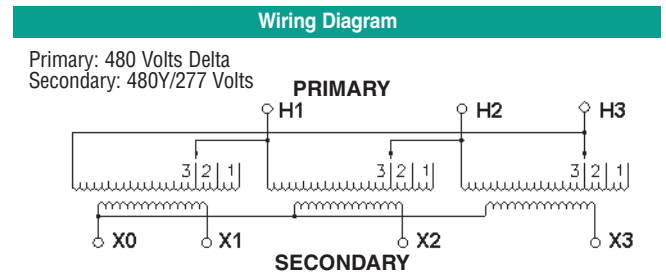


Connections		
Primary Volts	Jumper Taps To	Primary Lines Connect To
480	1	H1, H2, H3
456	2	H1, H2, H3
432	3	H1, H2, H3
Sec. Volts	Secondary Lines Connect To	
240	X1, X2, X3	

NOTE: Electrostatic shields are optionally available and not shown in all wiring diagrams. * Insulate unused taps individually.

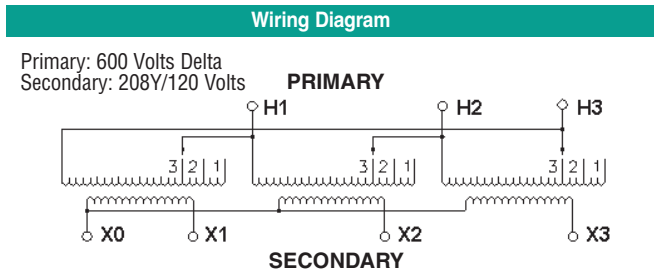
Three-Phase Encapsulated

T480C Wiring Diagram & Connections*



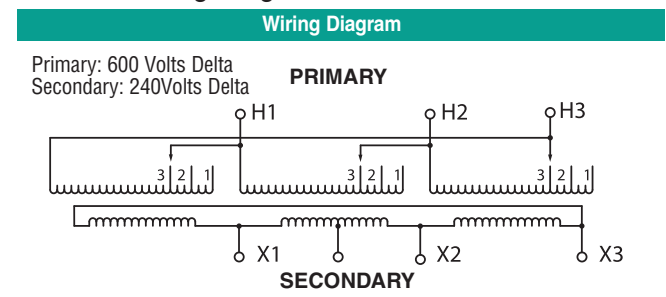
Connections		
Primary Volts	Jumper Taps To	Primary Lines Connect To
480	1	H1, H2, H3
456	2	H1, H2, H3
432	3	H1, H2, H3
Sec. Volts	Secondary Lines Connect To	
480	X1, X2, X3	
277	Between X0 and X1 or X2 or X3	
1 phase		

T600A Wiring Diagram & Connections*



Connections		
Primary Volts	Jumper Taps To	Primary Lines Connect To
600	1	H1, H2, H3
570	2	H1, H2, H3
540	3	H1, H2, H3
Sec. Volts	Secondary Lines Connect To	
208	X1, X2, X3	
120	Between X0 and X1 or X2 or X3	
1 phase		

T600E Wiring Diagram & Connections*



Connections		
Primary Volts	Jumper Taps To	Primary Lines Connect To
600	1	H1, H2, H3
570	2	H1, H2, H3
540	3	H1, H2, H3
Sec. Volts	Secondary Lines Connect To	
240	X1, X2, X3	

NOTE: Electrostatic shields are optionally available and not shown in all wiring diagrams. * Insulate unused taps individually.

Version JE901 0809 Date Sept 08



1-800-892-3755 www.jeffersonelectric.com

Dry-Type Transformers

4.7

4

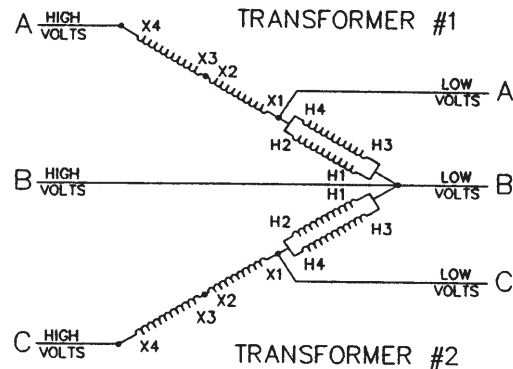
Three-Phase Encapsulated

Economical Auto Connections (Open Delta) for 411 Series

Three-Phase Using Two Single-Phase (Stock) Transformers

For proper overcurrent protection, refer to Article 450-4 of NEC

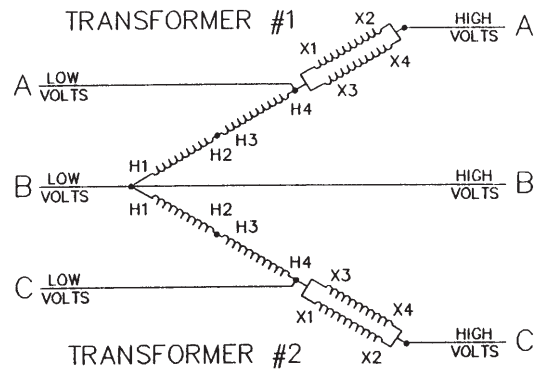
KVA*	High Volt Amps	Low Volt Amps	Qty.	Catalog Number	Catalog Number is for 1 transformer; 2 transformers are required
480 V Δ High V – 240 V Δ Low Volts (Open Delta)–3Φ, 60 Hz					
0.8	1.04	2.08	2	411-0041-000	
1.7	2.08	4.16	2	411-0051-000	
2.6	3.13	6.25	2	411-0061-000	
3.4	4.17	8.33	2	411-0071-000	
5.2	6.25	12.50	2	411-0081-000	
6.9	8.33	16.66	2	411-0091-000	
10.4	12.50	25.00	2	411-0101-000	
17.3	20.83	41.66	2	411-0111-000	
26.0	31.25	62.50	2	411-0131-000	
34.6	41.66	83.33	2	411-0151-000	
52.0	62.49	124.50	2	411-0161-000	
86.6	104.15	208.33	2	411-0181-000	



Three-Phase Using Two Single-Phase (Stock) Transformers

For proper overcurrent protection, refer to Article 450-4 of NEC

High Volt 600 Low Volt 480 KVA*	High Volt 480 Low Volt 380 KVA*	High Volt Amps	Low Volt Amps	Qty.	Catalog Number	Catalog Number is for 1 transformer; 2 transformers are required
600 V Δ High Volts – 480 V Δ Low Volts (Open Delta)–3Φ, 60 Hz						
480 V Δ High Volts – 380 V Δ Low Volts (Open Delta)–3Φ, 50/60 Hz						
2.1	1.7	2.09	2.60	2	411-0041-000	
4.3	3.4	4.17	5.20	2	411-0051-000	
6.5	5.1	6.25	7.81	2	411-0061-000	
8.6	6.9	8.33	10.41	2	411-0071-000	
13.0	10.4	12.50	15.62	2	411-0081-000	
17.3	13.9	16.67	20.83	2	411-0091-000	
26.0	20.8	25.00	31.25	2	411-0101-000	
43.3	34.6	41.67	52.08	2	411-0111-000	
65.0	52.0	62.50	78.12	2	411-0131-000	
86.6	69.2	83.33	104.17	2	411-0151-000	
130.0	103.9	125.0	156.35	2	411-0161-000	
216.5	173.2	208.3	260.4	2	411-0181-000	

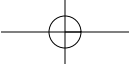


*KVA capacity of three-phase autotransformer bank, using two single-phase, 60 Hz transformers connected in open delta.

Note: Can be reverse connected with no change in KVA. Fuse input side per current NEC requirements.

Refer to tables in single phase sections for dimensions and weights.

Version JE901 0809 Date Sept 08



Three-Phase Ventilated

5



15 to 1000 KVA

Contents

Overview	5.2
Dimensional Drawings	5.7
Wiring Diagrams	5.8
Open Delta	5.14
Selection Charts	
208 V - 208Y/120 V	5.4
208 V - 480Y/277 V	5.4
240 V - 208Y/120 V	5.4
240 V - 480Y/277 V	5.4
480 V - 208Y/120 V	5.5
480 V - 240 V	5.5
480 V - 480Y/277 V	5.5
600 V - 208Y/120 V	5.5
600 V - 240 V	5.6
Suffix Chart	5.6

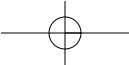
Version JE901 0809 Date Sept 08



1-800-892-3755 www.jeffersonelectric.com

Dry-Type Transformers

5.1



5

Three-Phase Ventilated

Products

- 150°C Temperature Rise: 15 KVA through 1000 KVA*
- 80°C and 115°C Temperature Rise: 15 KVA through 500 KVA*

Applications

- For general loads, indoors or out, including lighting, industrial and commercial applications

Specifications

- Cores of high quality electrical steel
- Meets Federally Mandated NEMA TP-1 Standard for energy efficiency
- NEMA 1-rated enclosures standard
- Electrostatic shields optional
- 60 Hz operation
- Aluminum or copper windings
- Taps provided on primary
- 220°C insulation class standard
- 150°C, 115°C, and 80°C temperature rise
- Heat-cured ASA-61 gray powder coat finish

Features, Functions, Benefits

- Designed for lower weight and smaller size for easier handling and installation
- Large connection compartment for ease of wiring and installation
- Quiet operation for installation flexibility
- Hassle-free front cover installation
- Taps provided on primary to compensate for voltage variations

Standards

- Built in accordance with NEMA, ANSI, UL and CSA standards

*Options and Accessories

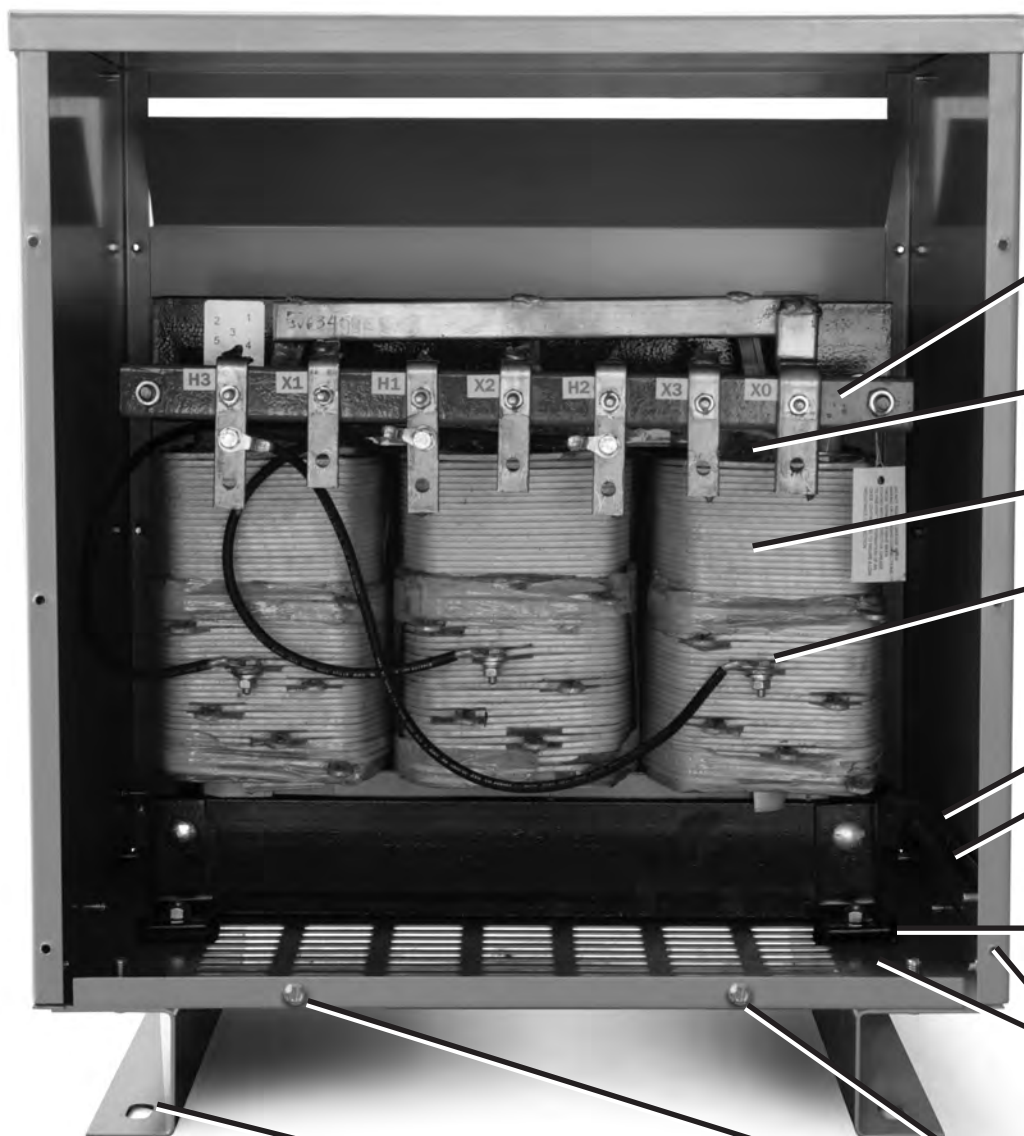
- CE Marked units available as custom
- Other sizes and voltages available as custom
- NEMA 3R-rated enclosures available with weather shields
- Wall mount brackets available for units up to 75 KVA with 150°C temperature rise

Version JE901 0809 Date Sept 08

Three-Phase Ventilated

Standard Construction Features

This drawing is for illustration purposes only. Please consult website or factory for construction details.



Fiberglass terminal board

Tightly stacked electrical steel core provides lower losses and low noise

Standard aluminum coils offer economical solution

Front loop taps are staggered for easy connection

Flexible core ground strap

Ground stud bolt

Vibration isolation pads provide quiet operation

Side or bottom conduit access for convenient mounting options

Bolt locations to hold front cover during installations loosen, don't remove

Easy access mounting holes

Version JE901.0809 Date Sept.08



1-800-892-3755

www.jeffersonelectric.com

Dry-Type Transformers

5.3

5

Three-Phase Ventilated

General Purpose
150°C Temperature Rise

Taps: 15 to 150 KVA 2@ 2.5% FCAN & 4@ 2.5% FCBN
225 to 500 KVA 1@ 5% FCAN & 2@ 5% FCBN
750 to 1000 KVA No Taps

KVA	Catalog Number*	Fig.	Height A (in.)	Width B (in.)	Depth C (in.)	Est. Ship Wgt. (lbs.)	Wiring Diagram	Weather Shield Kit	Wall Bracket Kit
208 V - 208Y/120 V – Aluminum windings*									
15	423-7168-000	7	22.0	19.0	16.0	210	T208B	423-0007-019	223-7008-030
30	423-7198-000	7	25.0	22.0	17.0	310		423-0007-022	223-7008-075
45	423-7218-000	7	28.0	25.0	18.5	400		423-0007-025	
75	423-7238-000	7	32.0	27.0	21.0	585		423-0007-027	
112.5	423-7258-000	7	38.0	29.0	23.0	775		423-0007-029	N/A
150	423-7268-000	7	42.0	33.0	26.0	1000	423-0007-033		
225	423-7298-000	7	46.0	35.0	30.0	1315	423-0007-035		
300	423-7318-000	7	52.0	35.0	30.0	1660	423-0007-035		
500	423-7348-000	7	60.0	48.0	33.0	2460	423-0007-048		
750	423-7368-000	7	72.0	52.0	40.0	3785	Included	N/A	
1000	423-7398-000	7	81.0	66.0	44.0	5050	Included		

208 V - 480Y/277 V – Aluminum windings*									
15	423-7161-000	7	22.0	19.0	16.0	210	T208D	423-0007-019	223-7008-030
30	423-7191-000	7	25.0	22.0	17.0	310		423-0007-022	223-7008-075
45	423-7211-000	7	28.0	25.0	18.5	400		423-0007-025	
75	423-7231-000	7	32.0	27.0	21.0	585		423-0007-027	
112.5	423-7251-000	7	38.0	29.0	23.0	775		423-0007-029	N/A
150	423-7261-000	7	42.0	33.0	26.0	1000	423-0007-033		
225	423-7291-000	7	46.0	35.0	30.0	1315	423-0007-035		
300	423-7311-000	7	52.0	35.0	30.0	1660	423-0007-035		
500	423-7341-000	7	60.0	48.0	33.0	2460	423-0007-048		
750	423-7361-000	7	72.0	52.0	40.0	3785	Included	N/A	
1000	423-7391-000	7	81.0	66.0	44.0	5050	Included		

240 V - 208Y/120 V – Aluminum windings*									
15	423-7162-000	7	22.0	19.0	16.0	210	T240B	423-0007-019	223-7008-030
30	423-7192-000	7	25.0	22.0	17.0	310		423-0007-022	223-7008-075
45	423-7212-000	7	28.0	25.0	18.5	400		423-0007-025	
75	423-7232-000	7	32.0	27.0	21.0	585		423-0007-027	
112.5	423-7252-000	7	38.0	29.0	23.0	775		423-0007-029	N/A
150	423-7262-000	7	42.0	33.0	26.0	1000	423-0007-033		
225	423-7292-000	7	46.0	35.0	30.0	1315	423-0007-035		
300	423-7312-000	7	52.0	35.0	30.0	1660	423-0007-035		
500	423-7342-000	7	60.0	48.0	33.0	2460	423-0007-048		
750	423-7362-000	7	72.0	52.0	40.0	3785	Included	N/A	
1000	423-7392-000	7	81.0	66.0	44.0	5050	Included		

240 V - 480Y/277 V – Aluminum windings*									
15	423-7163-000	7	22.0	19.0	16.0	210	T240D	423-0007-019	223-7008-030
30	423-7193-000	7	25.0	22.0	17.0	310		423-0007-022	223-7008-075
45	423-7213-000	7	28.0	25.0	18.5	400		423-0007-025	
75	423-7233-000	7	32.0	27.0	21.0	585		423-0007-027	
112.5	423-7253-000	7	38.0	29.0	23.0	775		423-0007-029	N/A
150	423-7263-000	7	42.0	33.0	26.0	1000	423-0007-033		
225	423-7293-000	7	46.0	35.0	30.0	1315	423-0007-035		
300	423-7313-000	7	52.0	35.0	30.0	1660	423-0007-035		
500	423-7343-000	7	60.0	48.0	33.0	2460	423-0007-048		
750	423-7363-000	7	72.0	52.0	40.0	3785	Included	N/A	
1000	423-7393-000	7	81.0	66.0	44.0	5050	Included		

* For units with an electrostatic shield, copper windings, and/or low temp rise requirements see suffix chart on page 5.6



Note: Housing dimensions subject to change without notice. Consult website or factory where dimensions are critical.



Version JE901 0809 Date Feb 09

Version JE901 0809 Date Feb 09

Three-Phase Ventilated

General Purpose 150°C Temperature Rise

Taps: 15 to 500 KVA 2@ 2.5% FCAN & 4@ 2.5% FCBN
750 to 1000 KVA 2@ 2.5% FCAN & 2@ 2.5% FCBN

KVA	Catalog Number*	Fig.	Height A (in.)	Width B (in.)	Depth C (in.)	Est. Ship Wgt. (lbs.)	Wiring Diagram	Weather Shield Kit	Wall Bracket Kit
480 V - 208Y/120 V – Aluminum windings*									
15	423-7164-000	7	22.0	19.0	16.0	210	T480E	423-0007-019	223-7008-030
30	423-7194-000	7	25.0	22.0	17.0	310		423-0007-022	223-7008-075
45	423-7214-000	7	28.0	25.0	18.5	400		423-0007-025	
75	423-7234-000	7	32.0	27.0	21.0	585		423-0007-027	
112.5	423-7254-000	7	38.0	29.0	23.0	775		423-0007-029	N/A
150	423-7264-000	7	42.0	33.0	26.0	1000		423-0007-033	
225	423-7294-000	7	46.0	35.0	30.0	1315		423-0007-035	
300	423-7314-000	7	52.0	35.0	30.0	1660		423-0007-035	
500	423-7344-000	7	60.0	48.0	33.0	2460		423-0007-048	
750	423-7364-000	7	72.0	52.0	40.0	3785		Included	
1000	423-7394-000	7	81.0	66.0	44.0	5050	T480M	Included	

480 V - 240 V – Aluminum windings* ++									
15	423-7167-000	7	22.0	19.0	16.0	210	T480G	423-0007-019	223-7008-030
30	423-7197-000	7	25.0	22.0	17.0	310		423-0007-022	223-7008-075
45	423-7217-000	7	28.0	25.0	18.5	400		423-0007-025	
75	423-7237-000	7	32.0	27.0	21.0	585		423-0007-027	
112.5	423-7257-000	7	38.0	29.0	23.0	775		423-0007-029	N/A
150	423-7267-000	7	42.0	33.0	26.0	1000		423-0007-033	
225	423-7297-000	7	46.0	35.0	30.0	1315		423-0007-035	
300	423-7317-000	7	52.0	35.0	30.0	1660		423-0007-035	
500	423-7347-000	7	60.0	48.0	33.0	2460		423-0007-048	
750	423-7367-000	7	72.0	52.0	40.0	3785		T480N	
1000	423-7397-000	7	81.0	66.0	44.0	5050	Included		

480 V - 480Y/277 V – Aluminum windings*									
15	423-7165-000	7	22.0	19.0	16.0	210	T480J	423-0007-019	223-7008-030
30	423-7195-000	7	25.0	22.0	17.0	310		423-0007-022	223-7008-075
45	423-7215-000	7	28.0	25.0	18.5	400		423-0007-025	
75	423-7235-000	7	32.0	27.0	21.0	585		423-0007-027	
112.5	423-7255-000	7	38.0	29.0	23.0	775		423-0007-029	N/A
150	423-7265-000	7	42.0	33.0	26.0	1000		423-0007-033	
225	423-7295-000	7	46.0	35.0	30.0	1315		423-0007-035	
300	423-7315-000	7	52.0	35.0	30.0	1660		423-0007-035	
500	423-7345-000	7	60.0	48.0	33.0	2460		423-0007-048	
750	423-7365-000	7	72.0	52.0	40.0	3785		T480P	
1000	423-7395-000	7	81.0	66.0	44.0	5050	Included		

600 V - 208Y/120 V – Aluminum windings*									
15	423-7169-000	7	22.0	19.0	16.0	210	T600B	423-0007-019	223-7008-030
30	423-7199-000	7	25.0	22.0	17.0	310		423-0007-022	223-7008-075
45	423-7219-000	7	28.0	25.0	18.5	400		423-0007-025	
75	423-7239-000	7	32.0	27.0	21.0	585		423-0007-027	
112.5	423-7259-000	7	38.0	29.0	23.0	775		423-0007-029	N/A
150	423-7269-000	7	42.0	33.0	26.0	1000		423-0007-033	
225	423-7299-000	7	46.0	35.0	30.0	1315		423-0007-035	
300	423-7319-000	7	52.0	35.0	30.0	1660		423-0007-035	
500	423-7349-000	7	60.0	48.0	33.0	2460		423-0007-048	
750	423-7369-000	7	72.0	52.0	40.0	3785		T600G	
1000	423-7399-000	7	81.0	66.0	44.0	5050	Included		

* For units with an electrostatic shield, copper windings, and/or low temp rise requirements see suffix chart on page 5.6

++ 120V center tap on center coil on 15 KVA through 1000 KVA units.

Caution: When using the 120 V center tap for single-phase applications, the single-phase load should not exceed 5% of the three-phase KVA rating. Connect the X3 "high leg" to the "B" phase per NEC 384-3 (do not use X3 leg for 120 V lighting). A separate single-phase transformer should be used if the single-phase load is in excess of 5%. Fuse input side per current NEC requirements.

Note: Housing dimensions subject to change without notice. Consult website or factory where dimensions are critical.



Version JE901 0809 Date Feb 09



1-800-892-3755 www.jeffersonelectric.com

Dry-Type Transformers

5.5

5

Three-Phase Ventilated

General Purpose

150°C Temperature Rise

Taps: 15 to 500 KVA 2@ 2.5% FCAN & 4@ 2.5% FCBN

750 to 1000 KVA 2@ 2.5% FCAN & 2@ 2.5% FCBN

KVA	Catalog Number*	Fig.	Height A (in.)	Width B (in.)	Depth C (in.)	Est. Ship Wgt. (lbs.)	Wiring Diagram	Weather Shield Kit	Wall Bracket Kit
600 V - 240 V – Aluminum windings* ++									
15	423-716A-000	7	22.0	19.0	16.0	210	T600D	423-0007-019	223-7008-030
30	423-719A-000	7	25.0	22.0	17.0	310		423-0007-022	223-7008-075
45	423-721A-000	7	28.0	25.0	18.5	400		423-0007-025	
75	423-723A-000	7	32.0	27.0	21.0	585		423-0007-027	
112.5	423-725A-000	7	38.0	29.0	23.0	775		423-0007-029	
150	423-726A-000	7	42.0	33.0	26.0	1000		423-0007-033	N/A
225	423-729A-000	7	46.0	35.0	30.0	1315		423-0007-035	
300	423-731A-000	7	52.0	35.0	30.0	1660		423-0007-035	
500	423-734A-000	7	60.0	48.0	33.0	2460		423-0007-048	
750	423-736A-000	7	72.0	52.0	40.0	3785		Included	
1000	423-739A-000	7	81.0	66.0	44.0	5050	Included		
							T600F		

* For units with an electrostatic shield, copper windings, and/or low temp rise requirements see suffix chart on page 5.6



Suffix Chart

The catalog number on the standard product has a suffix of -000

To order alternate version transformers choose the suffix to match the desired features.

Suffix	Wire	Temperature Rise	Electrostatic Shield
000	Aluminum	150	no shield
005	Aluminum	150	shield
010	Aluminum	115	no shield
015	Aluminum	115	shield
080	Aluminum	80	no shield
085	Aluminum	80	shield
800	Copper	150	no shield
805	Copper	150	shield
810	Copper	115	no shield
815	Copper	115	shield
880	Copper	80	no shield
885	Copper	80	shield

Note: The weight, dimensions, weather shield and mounting brackets may be different than the standard (-000) version.

Check our website www.jeffersonelectric.com for details

++ 120V center tap on center coil on 15 KVA through 1000 KVA units.

Caution: When using the 120 V center tap for single-phase applications, the single-phase load should not exceed 5% of the three-phase KVA rating. Connect the X3 "high leg" to the "B" phase per NEC 384-3 (do not use X3 leg for 120 V lighting). A separate single-phase transformer should be used if the single-phase load is in excess of 5%. Fuse input side per current NEC requirements.

Note: Housing dimensions subject to change without notice. Consult website or factory where dimensions are critical.

5.6

Dry-Type Transformers

www.jeffersonelectric.com

1-800-892-3755



Three-Phase Ventilated

Figure 7

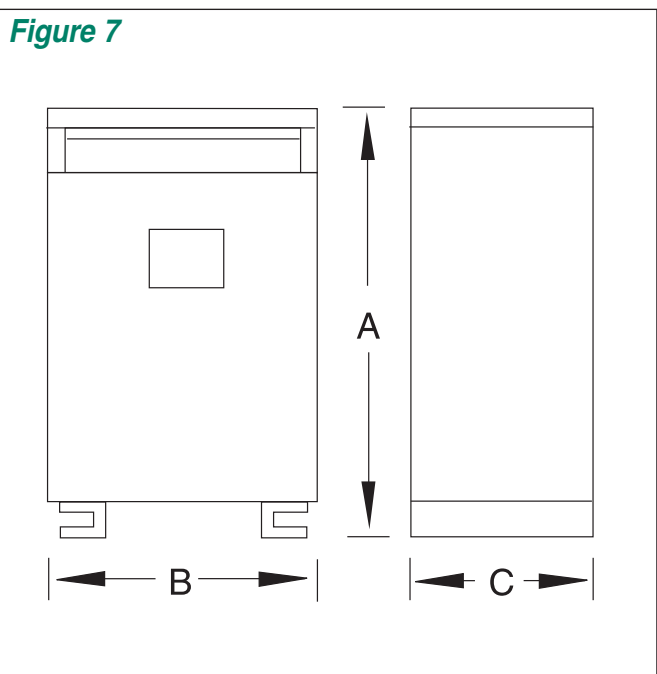
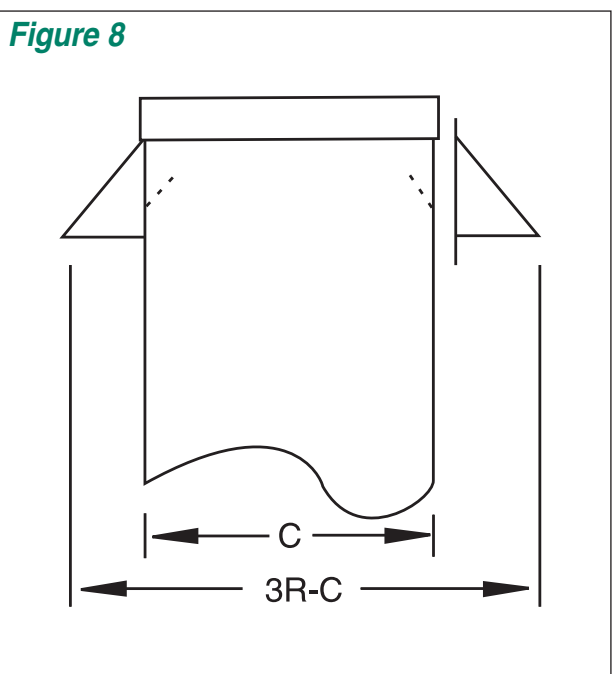


Figure 8



Weather Shield Kit to Make Enclosures NEMA 3R Rated

kVA*	Part Number	Width (B)	Depth w/o weather shield (C)	Depth with weather shield (3R-C)	Shipping weight (lbs.)
15	423-0007-019	19.0	16.0	23.0	3.2
30	423-0007-022	22.0	17.0	24.0	3.6
45	423-0007-025	25.0	18.5	25.5	4.1
75	423-0007-027	27.0	21.0	28.0	4.4
112.5	423-0007-029	29.0	23.0	31.0	5.3
150	423-0007-033	33.0	26.0	34.0	6.3
225	423-0007-035	35.0	30.0	38.0	6.7
300	423-0007-035	35.0	30.0	38.0	6.7
500	423-0007-048	48.0	33.0	43.5	12.2

*kVA for 150 degree rise units, low temp or K-factor units may use next larger weathershield

Mounting Brackets

Part Number	Description	Shipping weight (lbs.)
223-7008-030	For 15 KVA unit at 150 degree C rise	18
223-7008-075	For 16 to 75 KVA unit at 150 degree C rise	20

Version JE901 0809 Date Feb 09



1-800-892-3755 www.jeffersonelectric.com

Dry-Type Transformers

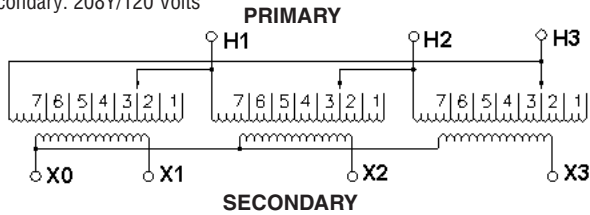
5

Three-Phase Ventilated

T208B Wiring Diagram & Connections*

Wiring Diagram

Primary: 208 Volts Delta
Secondary: 208Y/120 Volts



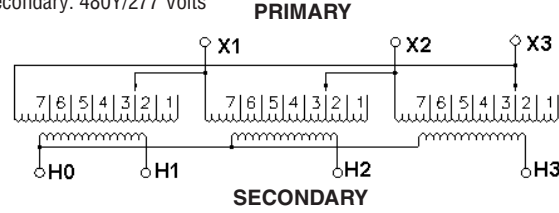
Connections

Primary Volts	On Each Coil Jumper Taps To	Primary Lines Connect To
218	1	H1, H2, H3
213	2	H1, H2, H3
208	3	H1, H2, H3
203	4	H1, H2, H3
198	5	H1, H2, H3
192	6	H1, H2, H3
187	7	H1, H2, H3
Sec. Volts	Secondary Lines Connect To	
208	X1, X2, X3	
120	Between X0 and X1 or X2 or X3	
1 Phase		

T208D Wiring Diagram & Connections*

Wiring Diagram

Primary: 208 Volts Delta
Secondary: 480Y/277 Volts



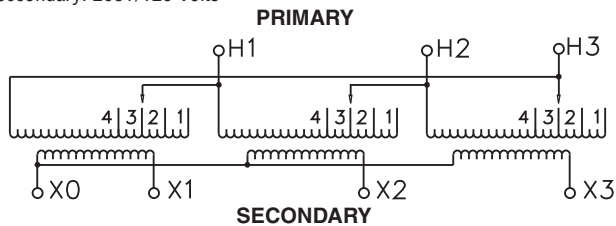
Connections

Primary Volts	On Each Coil Jumper Taps To	Primary Lines Connect To
218	1	X1, X2, X3
213	2	X1, X2, X3
208	3	X1, X2, X3
203	4	X1, X2, X3
198	5	X1, X2, X3
192	6	X1, X2, X3
187	7	X1, X2, X3
Sec. Volts	Secondary Lines Connect To	
480	H1, H2, H3	
277	Between H0 and H1 or H2 or H3	
1 Phase		

T208F Wiring Diagram & Connections*

Wiring Diagram

Primary: 208 Volts Delta
Secondary: 208Y/120 Volts



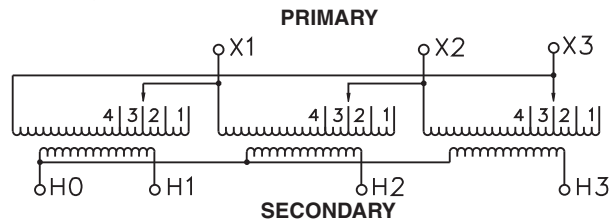
Connections

Primary Volts	On Each Coil Jumper Taps To	Primary Lines Connect To
218	1	H1, H2, H3
208	2	H1, H2, H3
198	3	H1, H2, H3
187	4	H1, H2, H3
Sec. Volts	Secondary Lines Connect To	
208	X1, X2, X3	
120	Between X0 and X1 or X2 or X3	
1 Phase		

T208G Wiring Diagram & Connections*

Wiring Diagram

Primary: 208 Volts Delta
Secondary: 480Y/277 Volts



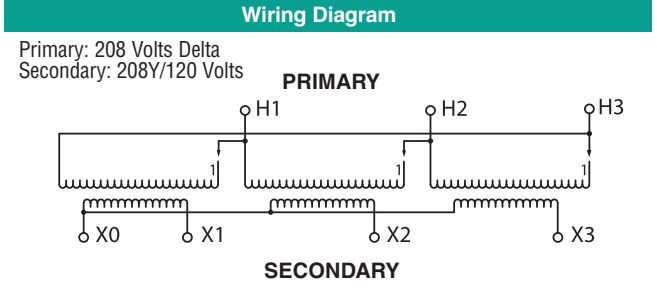
Connections

Primary Volts	On Each Coil Jumper Taps To	Primary Lines Connect To
218	1	X1, X2, X3
208	2	X1, X2, X3
198	3	X1, X2, X3
187	4	X1, X2, X3
Sec. Volts	Secondary Lines Connect To	
480	H1, H2, H3	
277	Between H0 and H1 or H2 or H3	
1 Phase		

NOTE: Electrostatic shields are optionally available and not shown in all wiring diagrams. * Insulate unused taps individually.

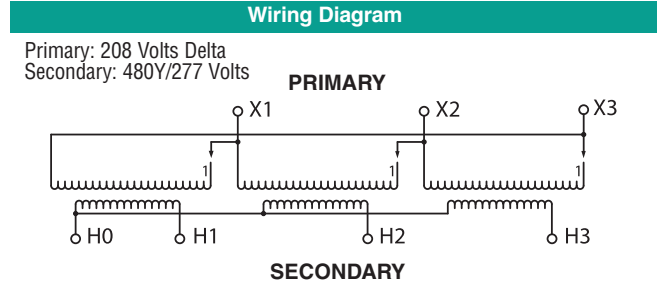
Three-Phase Ventilated

T208I Wiring Diagram & Connections*



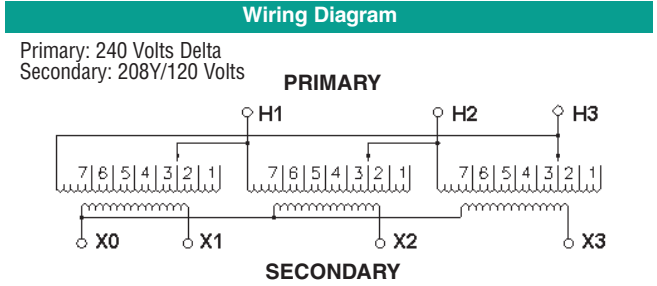
Connections		
Primary Volts	On Each Coil Jumper Taps To	Primary Lines Connect To
208	1	H1, H2, H3
Sec. Volts	Secondary Lines Connect To	
208	X1, X2, X3	
120	Between X0 and X1 or X2 or X3	
1 Phase		

T208J Wiring Diagram & Connections*



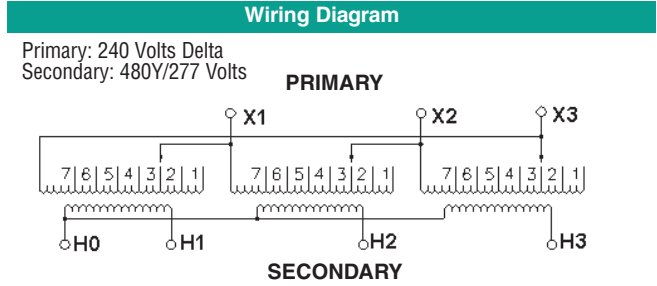
Connections		
Primary Volts	On Each Coil Jumper Taps To	Primary Lines Connect To
208	1	X1, X2, X3
Sec. Volts	Secondary Lines Connect To	
480	H1, H2, H3	
277	Between H0 and H1 or H2 or H3	
1 Phase		

T240B Wiring Diagram & Connections*



Connections		
Primary Volts	On Each Coil Jumper Taps To	Primary Lines Connect To
252	1	H1, H2, H3
246	2	H1, H2, H3
240	3	H1, H2, H3
234	4	H1, H2, H3
228	5	H1, H2, H3
222	6	H1, H2, H3
216	7	H1, H2, H3
Sec. Volts	Secondary Lines Connect To	
208	X1, X2, X3	
120	Between X0 and X1 or X2 or X3	
1 Phase		

T240D Wiring Diagram & Connections*



Connections		
Primary Volts	On Each Coil Jumper Taps To	Primary Lines Connect To
252	1	X1, X2, X3
246	2	X1, X2, X3
240	3	X1, X2, X3
234	4	X1, X2, X3
228	5	X1, X2, X3
222	6	X1, X2, X3
216	7	X1, X2, X3
Sec. Volts	Secondary Lines Connect To	
480	H1, H2, H3	
277	Between H0 and H1 or H2 or H3	
1 Phase		

NOTE: Electrostatic shields are optionally available and not shown in all wiring diagrams. * Insulate unused taps individually.

Version JE901 0809 Date Sept 08



1-800-892-3755 www.jeffersonelectric.com

Dry-Type Transformers

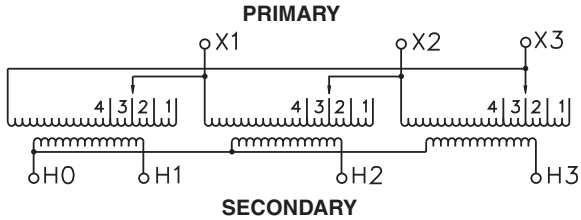
5

Three-Phase Ventilated

T240E Wiring Diagram & Connections*

Wiring Diagram

Primary: 240 Volts Delta
Secondary: 480Y/277 Volts



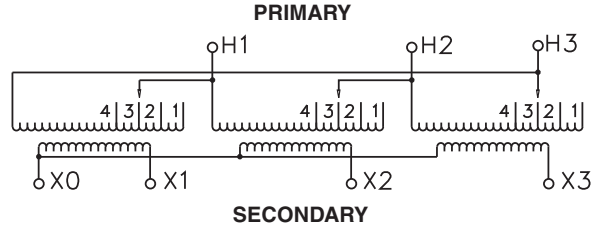
Connections

Primary Volts	On Each Coil Jumper Taps To	Primary Lines Connect To
252	1	X1, X2, X3
240	2	X1, X2, X3
228	3	X1, X2, X3
216	4	X1, X2, X3
Sec. Volts	Secondary Lines Connect To	
480	H1, H2, H3	
277	Between H0 and H1 or H2, or H3	
1 Phase		

T240F Wiring Diagram & Connections*

Wiring Diagram

Primary: 240 Volts Delta
Secondary: 208Y/120 Volts



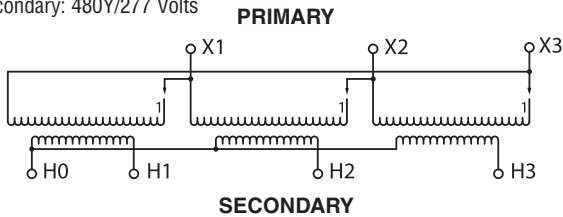
Connections

Primary Volts	On Each Coil Jumper Taps To	Primary Lines Connect To
252	1	H1, H2, H3
240	2	H1, H2, H3
228	3	H1, H2, H3
216	4	H1, H2, H3
Sec. Volts	Secondary Lines Connect To	
208	X1, X2, X3	
120	Between X0 and X1 or X2, or X3	
1 Phase		

T240H Wiring Diagram & Connections*

Wiring Diagram

Primary: 240 Volts Delta
Secondary: 480Y/277 Volts



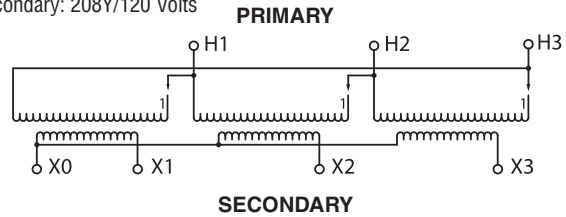
Connections

Primary Volts	On Each Coil Jumper Taps To	Primary Lines Connect To
240	1	X1, X2, X3
Sec. Volts	Secondary Lines Connect To	
480	H1, H2, H3	
277	Between H0 and H1 or H2 or H3	
1 Phase		

T240I Wiring Diagram & Connections*

Wiring Diagram

Primary: 240 Volts Delta
Secondary: 208Y/120 Volts



Connections

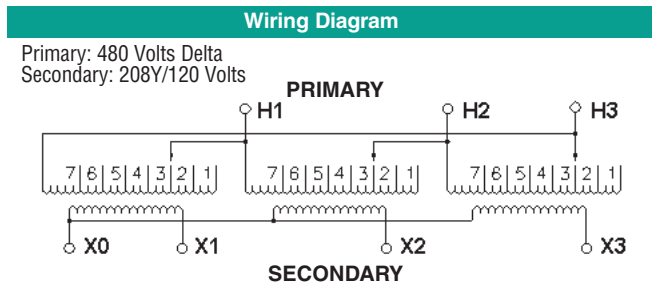
Primary Volts	On Each Coil Jumper Taps To	Primary Lines Connect To
240	1	H1, H2, H3
Sec. Volts	Secondary Lines Connect To	
208	X1, X2, X3	
120	Between X0 and X1 or X2 or X3	
1 Phase		

Version JE901.0612 Date Dec.06

Version JE901.0612 Date Dec.06

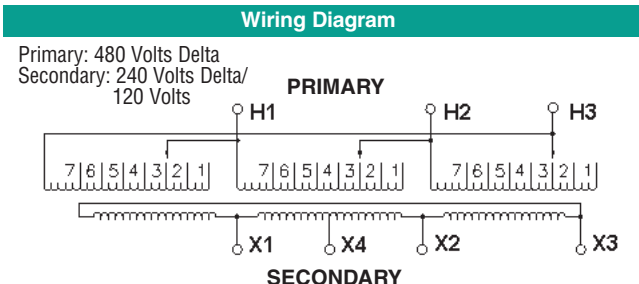
Three-Phase Ventilated

T480E Wiring Diagram & Connections*



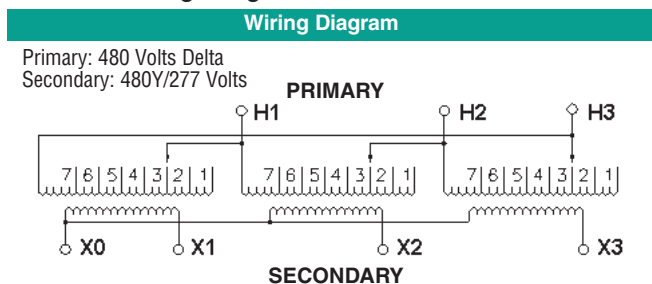
Connections		
Primary Volts	On Each Coil Jumper Taps To	Primary Lines Connect To
504	1	H1, H2, H3
492	2	H1, H2, H3
480	3	H1, H2, H3
468	4	H1, H2, H3
456	5	H1, H2, H3
444	6	H1, H2, H3
432	7	H1, H2, H3
Sec. Volts	Secondary Lines Connect To	
208	X1, X2, X3	
120	Between X0 and X1 or X2 or X3	
1 Phase		

T480G Wiring Diagram & Connections*



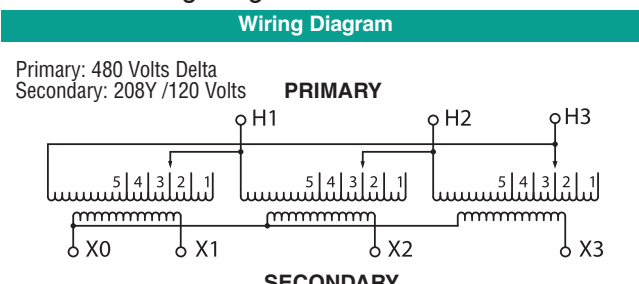
Connections		
Primary Volts	On Each Coil Jumper Taps To	Primary Lines Connect To
504	1	H1, H2, H3
492	2	H1, H2, H3
480	3	H1, H2, H3
468	4	H1, H2, H3
456	5	H1, H2, H3
444	6	H1, H2, H3
432	7	H1, H2, H3
Sec. Volts	Secondary Lines Connect To	
240	X1, X2, X3	
120	X1 and X4 or X2 and X4	
1 Phase		

T480J Wiring Diagram & Connections*



Connections		
Primary Volts	On Each Coil Jumper Taps To	Primary Lines Connect To
504	1	H1, H2, H3
492	2	H1, H2, H3
480	3	H1, H2, H3
468	4	H1, H2, H3
456	5	H1, H2, H3
444	6	H1, H2, H3
432	7	H1, H2, H3
Sec. Volts	Secondary Lines Connect To	
480	X1, X2, X3	
277	Between X0 and X1 or X2 or X3	
1 Phase		

T480M Wiring Diagram & Connections*



Connections		
Primary Volts	On Each Coil Jumper Taps To	Primary Lines Connect To
504	1	H1, H2, H3
492	2	H1, H2, H3
480	3	H1, H2, H3
468	4	H1, H2, H3
456	5	H1, H2, H3
Sec. Volts	Secondary Lines Connect To	
208	X1, X2, X3	
120	X1 and X4 or X2 and X4	
1 Phase		

Version JE901.0612 Date Dec.06



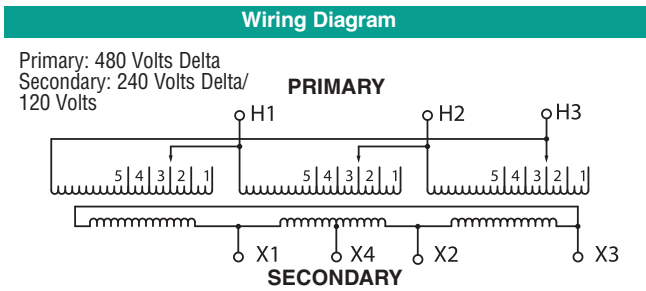
1-800-892-3755 www.jeffersonelectric.com

Dry-Type Transformers

5.11

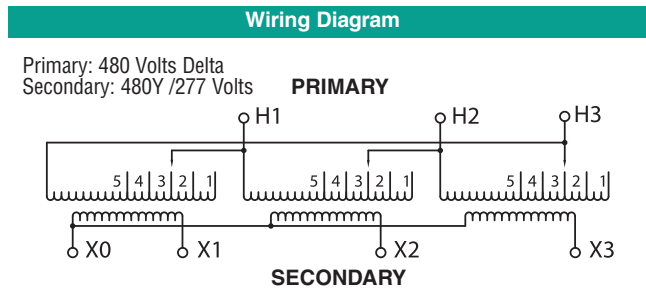
5 Three-Phase Ventilated

T480N Wiring Diagram & Connections*



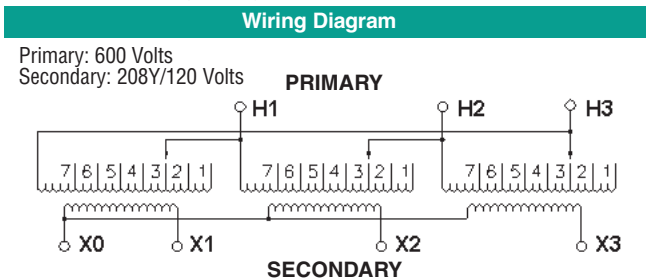
Connections		
Primary Volts	On Each Coil Jumper Taps To	Primary Lines Connect To
504	1	H1, H2, H3
492	2	H1, H2, H3
480	3	H1, H2, H3
468	4	H1, H2, H3
456	5	H1, H2, H3
Sec. Volts	Secondary Lines Connect To	
240	X1, X2, X3	
120	X1 and X4 or X2 and X4	
1 Phase		

T480P Wiring Diagram & Connections*



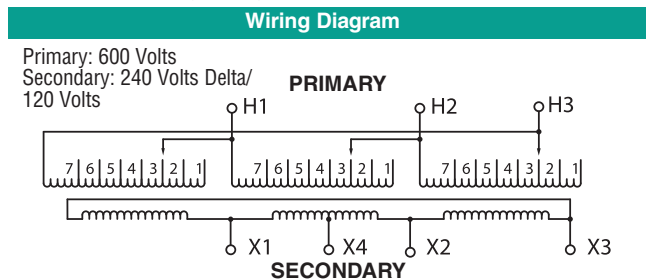
Connections		
Primary Volts	On Each Coil Jumper Taps To	Primary Lines Connect To
504	1	H1, H2, H3
492	2	H1, H2, H3
480	3	H1, H2, H3
468	4	H1, H2, H3
456	5	H1, H2, H3
Sec. Volts	Secondary Lines Connect To	
480	X1, X2, X3	
277	Between X0 and X1 or X2 or X3	
1 Phase		

T600B Wiring Diagram & Connections*



Connections		
Primary Volts	On Each Coil Jumper Taps To	Primary Lines Between Lines
630	1	H1, H2, H3
615	2	H1, H2, H3
600	3	H1, H2, H3
585	4	H1, H2, H3
570	5	H1, H2, H3
555	6	H1, H2, H3
540	7	H1, H2, H3
Sec. Volts	Secondary Lines Connect To	
208	X1, X2, X3	
120	Between X0 and X1 or X2 or X3	
1 Phase		

T600D Wiring Diagram & Connections*

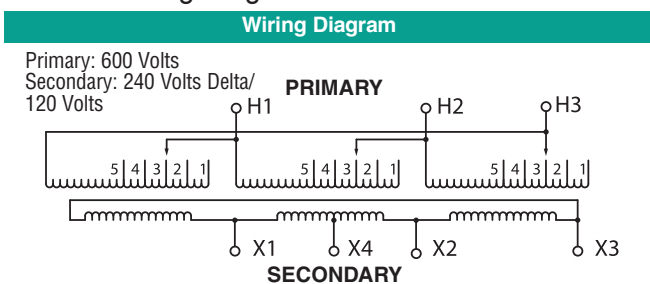


Connections		
Primary Volts	On Each Coil Jumper Taps To	Primary Lines Between Lines
630	1	H1, H2, H3
615	2	H1, H2, H3
600	3	H1, H2, H3
585	4	H1, H2, H3
570	5	H1, H2, H3
555	6	H1, H2, H3
540	7	H1, H2, H3
Sec. Volts	Secondary Lines Connect To	
240	X1, X2, X3	
120	X1 and X4 or X2 and X4	
1 Phase		

NOTE: Electrostatic shields are optionally available and not shown in all wiring diagrams. * Insulate unused taps individually.

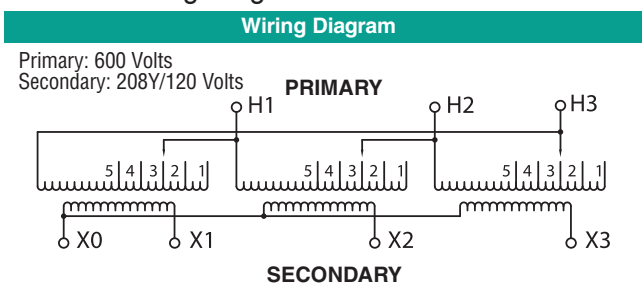
Three-Phase Ventilated

T600F Wiring Diagram & Connections*



Connections		
Primary Volts	On Each Coil Jumper Taps To	Primary Lines Between Lines
630	1	H1, H2, H3
615	2	H1, H2, H3
600	3	H1, H2, H3
585	4	H1, H2, H3
570	5	H1, H2, H3
Sec. Volts	Secondary Lines Connect To	
240	X1, X2, X3	
120	X1 and X4 or X2 and X4	
1 Phase		

T600G Wiring Diagram & Connections*



Connections		
Primary Volts	On Each Coil Jumper Taps To	Primary Lines Between Lines
630	1	H1, H2, H3
615	2	H1, H2, H3
600	3	H1, H2, H3
585	4	H1, H2, H3
570	5	H1, H2, H3
Sec. Volts	Secondary Lines Connect To	
208	X1, X2, X3	
120	Between X0 and X1 or X2 or X3	
1 Phase		

Version JE901_0612 Date Feb 09



1-800-892-3755 www.jeffersonelectric.com

Dry-Type Transformers

5.13

5

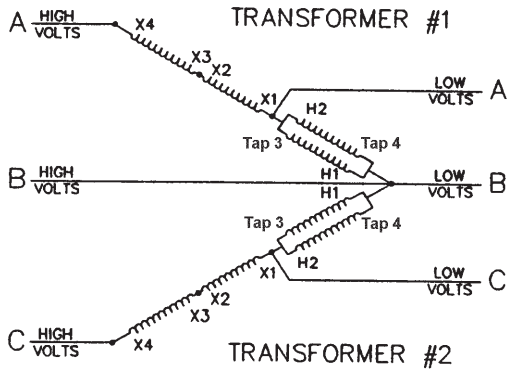
Three-Phase Ventilated

Economical Auto Connections (Open Delta) for 421 Series

Three-Phase Using Two Single-Phase (Stock) Transformers

For proper overcurrent protection, refer to Article 450-4 of NEC

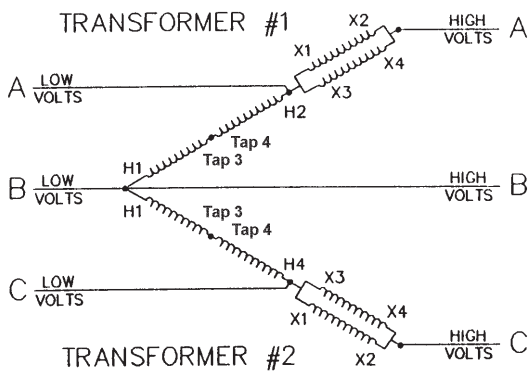
KVA*	High Volt Amps	Low Volt Amps	Qty.	Catalog Number	Catalog Number is for 1 transformer; 2 transformers are required
480 V Δ High V – 240 V Δ Low Volts (Open Delta)–3Φ, 60 Hz					
86.6	104.15	208.33	2	421-7185-000	
129.9	156.23	312.50	2	421-7205-000	
173.2	208.33	416.66	2	421-7225-000	
259.8	312.50	625.00	2	421-7235-000	



Three-Phase Using Two Single-Phase (Stock) Transformers

For proper overcurrent protection, refer to Article 450-4 of NEC

High Volt 600 Low Volt 480 KVA*	High Volt 480 Low Volt 380 KVA*	High Volt Amps	Low Volt Amps	Qty.	Catalog Number	Catalog Number is for 1 transformer; 2 transformers are required
600 V Δ High Volts – 480 V Δ Low Volts (Open Delta)–3Φ, 60 Hz						
480 V Δ High Volts – 380 V Δ Low Volts (Open Delta)–3Φ, 50/60 Hz						
216.5	173.2	208.3	260.4	2	421-7185-000	
324.7	259.8	312.8	390.6	2	421-7205-000	
433.0	346.4	416.7	520.8	2	421-7225-000	
649.5	519.6	625.0	781.0	2	421-7235-000	
866.0	692.8	834.0	1041.0	2	421-7245-000	



*KVA capacity of three-phase autotransformer bank, using two single-phase, 60 Hz transformers connected in open delta.
 Note: Can be reverse connected with no change in KVA. Fuse input side per current NEC requirements.
 Refer to tables in single phase sections for dimensions and weights.

Version _JE901.0612 Date _Dec.06





3 to 990 KVA

Contents

Overview	7.2
Drive Selector	7.3
Dimensional Drawings	7.7
Wiring Diagrams	7.8
Selection Charts	
230 V - 230Y/133 V	7.4
230 V - 460Y/266 V	7.4
460 V - 230Y/133 V	7.5
460 V - 460Y/266 V	7.5
575 V - 230Y/133 V	7.6
575 V - 460Y/266 V	7.6

Products

- *Three-Phase Encapsulated: 3 KVA through 11 KVA**
- *Three-Phase Ventilated: 14 KVA through 990 KVA**

Applications

- *For industrial and commercial applications with SCR-controlled adjustable speed motor drives, and AC adjustable frequency or DC drives*

Specifications

- *Complete KVA range to cover all standard drive systems*
- *Cores of high quality electrical steel*
- *NEMA 3R-rated enclosures standard on 3 KVA through 11 KVA units*
- *NEMA 1-rated enclosures standard on 14 KVA through 990 KVA units*
- *Delta primary, wye secondary to match common power sources in most three-phase rectified circuits*
- *3KVA through 11KVA, 135°C temp rise*
- *14KVA through 990KVA, 150°C temperature rise standard on 220°C insulation class units*
- *Heat-cured ASA-61 gray powder coat finish*

Features, Functions, Benefits

- *Large connection compartment for ease of wiring and installation*
- *Internally braced for short circuit stress protection*
- *Low impedance for better voltage regulation*
- *Low flux density to minimize core saturation*
- *Tap arrangements provided to compensate for input voltage variation*
- *Quiet operation for installation flexibility*

Standards

- *Built in accordance with NEMA, ANSI, UL and CSA standards*

***Options and Accessories**

- *CE Marked units available as custom*
- *80°C and 115°C temperature rise available*
- *Wall mount brackets available on units up to 75 KVA and 150°C temperature rise*
- *Weathershields available on units 14 KVA through 990 KVA*
- *Copper windings available*

Drive Isolation

Designed to withstand periodic over current loads caused by electronic motor drives. DIT applications include SCR-controlled adjustable speed motor drives, and AC adjustable frequency or DC drives

Drive Selector Chart

To determine the proper size drive isolation transformer, locate the HP of the motors to be operated in the left hand column. The corresponding figure in the right hand column is the recommended transformer KVA. Use the selection table to determine the drive isolation transformer catalog number.

SELECTOR CHART

HP	KVA
2	3
3	6
5	7.5
7.5	11
10	14
15	20
20	27
25	34
30	40
40	51
50	63
60	75
75	93
100	118
125	145
150	175
200	220
250	275
300	330
400	440
500	550

Drive Isolation (DIT)

Primary 230 V Delta (Secondary 230Y/133) Taps: 1 @ 5%FCAN, 1 @ 5% FCBN

kVA	Old Catalog #	New Catalog #	Dimensions (inches)			Weight (lbs)	Figure	Wiring Diagram	Weather Shield
			A (H)	B (W)	C (D)				
3	413-0018-051	413-6ACC-000	13	15	8.06	82	4	DIT-CC	N/A
6	413-0019-051	413-6BCC-000	13	15	8.06	119	4	DIT-CC	N/A
7.5	413-0020-051	413-6CCC-000	15	19	9.06	157	4	DIT-CC	N/A
11	413-0021-051	413-6DCC-000	15	19	9.06	228	4	DIT-CC	N/A
14	423-0020-051	423-6ECC-000	22	19	16	255	7	DIT-CC	423-0007-019
20	423-0021-051	423-6FCC-000	22	19	16	255	7	DIT-CC	423-0007-019
27	423-0022-051	423-6GCC-000	25	22	17	295	7	DIT-CC	423-0007-022
34	423-0023-051	423-6HCC-000	25	22	17	295	7	DIT-CC	423-0007-022
40	423-0024-051	423-6JCC-000	28	25	19	350	7	DIT-CC	423-0007-025
51	423-0025-051	423-6KCC-000	28	25	19	350	7	DIT-CC	423-0007-025
63	423-0026-051	423-6LCC-000	32	27	21	535	7	DIT-CC	423-0007-027
75	423-0027-051	423-6MCC-000	32	27	21	535	7	DIT-CC	423-0007-027
93	423-0028-051	423-6NCC-000	38	29	23	675	7	DIT-CC	423-0007-029
118	423-0029-051	423-6PCC-000	38	29	23	835	7	DIT-CC	423-0007-029
145	423-0030-051	423-6RCC-000	42	33	26	980	7	DIT-CC	423-0007-033
175	223-0031-651	423-6SCC-000	46	35	30	1200	7	DIT-CC	423-0007-035
220	223-0032-651	423-6TCC-000	46	35	30	1380	7	DIT-CC	423-0007-035
275	223-0033-651	423-6UCC-000	46	35	30	1590	7	DIT-CC	423-0007-035
330	223-0034-651	423-6VCC-000	60	48	33	1680	7	DIT-CC	423-0007-048
440	223-0035-651	423-6WCC-000	60	48	33	2030	7	DIT-CC	423-0007-048
550	223-0036-651	423-6XCC-000	60	48	33	2530	7	DIT-CC	423-0007-048

Primary 230 V Delta (Secondary 460Y/266) Taps: 1 @ 5%FCAN, 1 @ 5% FCBN

kVA	Old Catalog #	New Catalog #	Dimensions (inches)			Weight (lbs)	Figure	Wiring Diagram	Weather Shield
			A (H)	B (W)	C (D)				
3	413-0018-056	413-6ACG-000	13	15	8.06	82	4	DIT-CG	N/A
6	413-0019-056	413-6BCG-000	13	15	8.06	119	4	DIT-CG	N/A
7.5	413-0020-056	413-6CCG-000	15	19	9.06	157	4	DIT-CG	N/A
11	413-0021-056	413-6DCG-000	15	19	9.06	228	4	DIT-CG	N/A
14	423-0020-056	423-6ECG-000	22	19	16	255	7	DIT-CG	423-0007-019
20	423-0021-056	423-6FCG-000	22	19	16	255	7	DIT-CG	423-0007-019
27	423-0022-056	423-6GCG-000	25	22	17	295	7	DIT-CG	423-0007-022
34	423-0023-056	423-6HCG-000	25	22	17	295	7	DIT-CG	423-0007-022
40	423-0024-056	423-6JCG-000	28	25	19	350	7	DIT-CG	423-0007-025
51	423-0025-056	423-6KCG-000	28	25	19	350	7	DIT-CG	423-0007-025
63	423-0026-056	423-6LCG-000	32	27	21	445	7	DIT-CG	423-0007-027
75	423-0027-056	423-6MCG-000	32	27	21	535	7	DIT-CG	423-0007-027
93	423-0028-056	423-6NCG-000	38	29	23	675	7	DIT-CG	423-0007-029
118	423-0029-056	423-6PCG-000	38	29	23	835	7	DIT-CG	423-0007-029
145	423-0030-056	423-6RCG-000	42	33	26	980	7	DIT-CG	423-0007-033
175	223-0031-656	423-6SCG-000	46	35	30	1200	7	DIT-CG	423-0007-035
220	223-0032-656	423-6TCG-000	46	35	30	1380	7	DIT-CG	423-0007-035
275	223-0033-656	423-6UCG-000	46	35	30	1590	7	DIT-CG	423-0007-035
330	223-0034-656	423-6VCG-000	60	48	33	1680	7	DIT-CG	423-0007-048
440	223-0035-656	423-6WCG-000	60	48	33	2030	7	DIT-CG	423-0007-048
550	223-0036-656	423-6XCG-000	60	48	33	2530	7	DIT-CG	423-0007-048

Date: Dec 09

Drive Isolation (DIT)

Primary 460 V Delta (Secondary 230Y/133) Taps: 1 @ 5%FCAN, 1 @ 5% FCBN

kVA	Old Catalog #	New Catalog #	Dimensions (inches)			Weight (lbs)	Figure	Wiring Diagram	Weather Shield
			A (H)	B (W)	C (D)				
3	413-0018-052	413-6AGC-000	13	15	8.06	82	4	DIT-GC	N/A
6	413-0019-052	413-6BGC-000	13	15	8.06	119	4	DIT-GC	N/A
7.5	413-0020-052	413-6CGC-000	15	19	9.06	157	4	DIT-GC	N/A
11	413-0021-052	413-6DGC-000	15	19	9.06	228	4	DIT-GC	N/A
14	423-0020-052	423-6EGC-000	22	19	16	255	7	DIT-GC	423-0007-019
20	423-0021-052	423-6FGC-000	22	19	16	255	7	DIT-GC	423-0007-019
27	423-0022-052	423-6GGC-000	25	22	17	295	7	DIT-GC	423-0007-022
34	423-0023-052	423-6HGC-000	25	22	17	295	7	DIT-GC	423-0007-022
40	423-0024-052	423-6JGC-000	28	25	19	350	7	DIT-GC	423-0007-025
51	423-0025-052	423-6KGC-000	28	25	19	350	7	DIT-GC	423-0007-025
63	423-0026-052	423-6LGC-000	32	27	21	535	7	DIT-GC	423-0007-027
75	423-0027-052	423-6MGC-000	32	27	21	535	7	DIT-GC	423-0007-027
93	423-0028-052	423-6NGC-000	38	29	23	675	7	DIT-GC	423-0007-029
118	423-0029-052	423-6PGC-000	38	29	23	835	7	DIT-GC	423-0007-029
145	423-0030-052	423-6RGC-000	42	33	26	980	7	DIT-GC	423-0007-033
175	223-0031-652	423-6SGC-000	46	35	30	1200	7	DIT-GC	423-0007-035
220	223-0032-652	423-6TGC-000	46	35	30	1380	7	DIT-GC	423-0007-035
275	223-0033-652	423-6UGC-000	46	35	30	1590	7	DIT-GC	423-0007-035
330	223-0034-652	423-6VGC-000	60	48	33	1680	7	DIT-GC	423-0007-048
440	223-0035-652	423-6WGC-000	60	48	33	2030	7	DIT-GC	423-0007-048
550	223-0036-652	423-6XGC-000	60	48	33	2530	7	DIT-GC	423-0007-048

Primary 460 V Delta (Secondary 460Y/266) Taps: 1 @ 5%FCAN, 1 @ 5% FCBN

kVA	Old Catalog #	New Catalog #	Dimensions (inches)			Weight (lbs)	Figure	Wiring Diagram	Weather Shield
			A (H)	B (W)	C (D)				
3	413-0018-054	413-6AGG-000	13	15	8.06	82	4	DIT-GG	N/A
6	413-0019-054	413-6BGG-000	13	15	8.06	119	4	DIT-GG	N/A
7.5	413-0020-054	413-6CGG-000	15	19	9.06	157	4	DIT-GG	N/A
11	413-0021-054	413-6DGG-000	15	19	9.06	228	4	DIT-GG	N/A
14	423-0020-054	423-6EGG-000	22	19	16	255	7	DIT-GG	423-0007-019
20	423-0021-054	423-6FGG-000	22	19	16	255	7	DIT-GG	423-0007-019
27	423-0022-054	423-6GGG-000	25	22	17	295	7	DIT-GG	423-0007-022
34	423-0023-054	423-6HGG-000	25	22	17	295	7	DIT-GG	423-0007-022
40	423-0024-054	423-6JGG-000	28	25	19	350	7	DIT-GG	423-0007-025
51	423-0025-054	423-6KGG-000	28	25	19	350	7	DIT-GG	423-0007-025
63	423-0026-054	423-6LGG-000	32	27	21	535	7	DIT-GG	423-0007-027
75	423-0027-054	423-6MGG-000	32	27	21	535	7	DIT-GG	423-0007-027
93	423-0028-054	423-6NGG-000	38	29	23	675	7	DIT-GG	423-0007-029
118	423-0029-054	423-6PGG-000	38	29	23	835	7	DIT-GG	423-0007-029
145	423-0030-054	423-6RGG-000	42	33	26	980	7	DIT-GG	423-0007-033
175	223-0031-654	423-6SGG-000	46	35	30	1200	7	DIT-GG	423-0007-035
220	223-0032-654	423-6TGG-000	46	35	30	1380	7	DIT-GG	423-0007-035
275	223-0033-654	423-6UGG-000	46	35	30	1590	7	DIT-GG	423-0007-035
330	223-0034-654	423-6VGG-000	60	48	33	1680	7	DIT-GG	423-0007-048
440	223-0035-654	423-6WGG-000	60	48	33	2030	7	DIT-GG	423-0007-048
550	223-0036-654	423-6XGG-000	60	48	33	2530	7	DIT-GG	423-0007-048

Date Dec 09

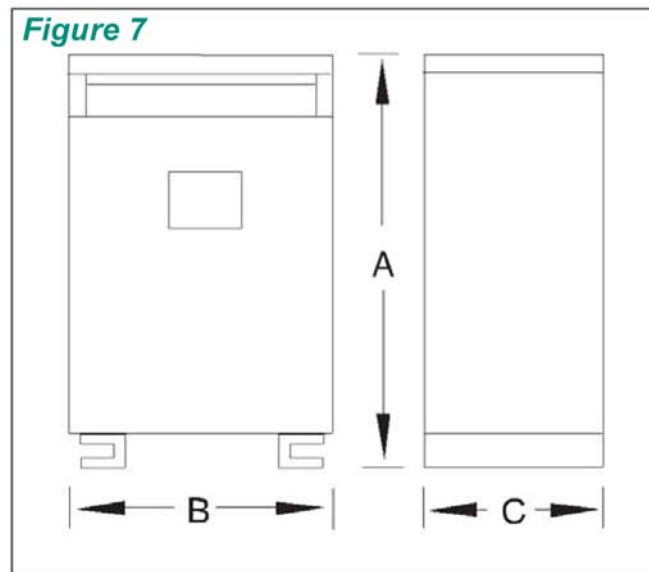
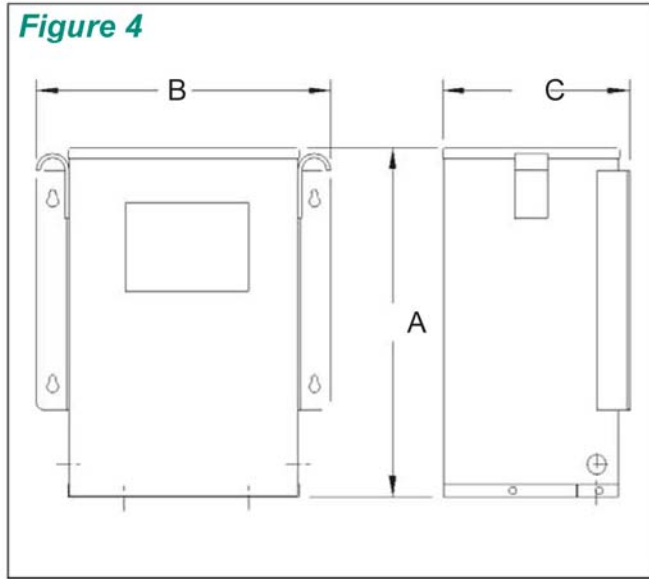
Drive Isolation (DIT)**Primary 575 V Delta (Secondary 230Y/133) Taps: 1 @ 5%FCAN, 1 @ 5% FCBN**

kVA	Old Catalog #	New Catalog #	Dimensions (inches)			Weight (lbs)	Figure	Wiring Diagram	Weather Shield
			A (H)	B (W)	C (D)				
3	413-0018-053	413-6ALC-000	13	15	8.06	82	4	DIT-LC	N/A
6	413-0019-053	413-6BLC-000	13	15	8.06	119	4	DIT-LC	N/A
7.5	413-0020-053	413-6CLC-000	15	19	9.06	157	4	DIT-LC	N/A
11	413-0021-053	413-6DLC-000	15	19	9.06	228	4	DIT-LC	N/A
14	423-0020-053	423-6ELC-000	22	19	16	255	7	DIT-LC	423-0007-019
20	423-0021-053	423-6FLC-000	22	19	16	255	7	DIT-LC	423-0007-019
27	423-0022-053	423-6GLC-000	25	22	17	295	7	DIT-LC	423-0007-022
34	423-0023-053	423-6HLC-000	25	22	17	295	7	DIT-LC	423-0007-022
40	423-0024-053	423-6JLC-000	28	25	19	350	7	DIT-LC	423-0007-025
51	423-0025-053	423-6KLC-000	28	25	19	350	7	DIT-LC	423-0007-025
63	423-0026-053	423-6LLC-000	32	27	21	535	7	DIT-LC	423-0007-027
75	423-0027-053	423-6MLC-000	32	27	21	535	7	DIT-LC	423-0007-027
93	423-0028-053	423-6NLC-000	38	29	23	675	7	DIT-LC	423-0007-029
118	423-0029-053	423-6PLC-000	38	29	23	835	7	DIT-LC	423-0007-029
145	423-0030-053	423-6RLC-000	42	33	26	980	7	DIT-LC	423-0007-033
175	223-0031-653	423-6SLC-000	46	35	30	1200	7	DIT-LC	423-0007-035
220	223-0032-653	423-6TLC-000	46	35	30	1380	7	DIT-LC	423-0007-035
275	223-0033-653	423-6ULC-000	46	35	30	1590	7	DIT-LC	423-0007-035
330	223-0034-653	423-6VLC-000	60	48	33	1680	7	DIT-LC	423-0007-048
440	223-0035-653	423-6WLC-000	60	48	33	2030	7	DIT-LC	423-0007-048
550	223-0036-653	423-6XLC-000	60	48	33	2530	7	DIT-LC	423-0007-048

Primary 575 V Delta (Secondary 460Y/266) Taps: 1 @ 5%FCAN, 1 @ 5% FCBN

kVA	Old Catalog #	New Catalog #	Dimensions (inches)			Weight (lbs)	Figure	Wiring Diagram	Weather Shield
			A (H)	B (W)	C (D)				
3	413-0018-055	413-6ALG-000	13	15	8.06	82	4	DIT-LG	N/A
6	413-0019-055	413-6BLG-000	13	15	8.06	119	4	DIT-LG	N/A
7.5	413-0020-055	413-6CLG-000	15	19	9.06	157	4	DIT-LG	N/A
11	413-0021-055	413-6DLG-000	15	19	9.06	228	4	DIT-LG	N/A
14	423-0020-055	423-6ELG-000	22	19	16	255	7	DIT-LG	423-0007-019
20	423-0021-055	423-6FLG-000	22	19	16	255	7	DIT-LG	423-0007-019
27	423-0022-055	423-6GLG-000	25	22	17	295	7	DIT-LG	423-0007-022
34	423-0023-055	423-6HLG-000	25	22	17	295	7	DIT-LG	423-0007-022
40	423-0024-055	423-6JLG-000	28	25	19	350	7	DIT-LG	423-0007-025
51	423-0025-055	423-6KLG-000	28	25	19	350	7	DIT-LG	423-0007-025
63	423-0026-055	423-6LLG-000	32	27	21	535	7	DIT-LG	423-0007-027
75	423-0027-055	423-6MLG-000	32	27	21	535	7	DIT-LG	423-0007-027
93	423-0028-055	423-6NLG-000	38	29	23	675	7	DIT-LG	423-0007-029
118	423-0029-055	423-6PLG-000	38	29	23	835	7	DIT-LG	423-0007-029
145	423-0030-055	423-6RLG-000	42	33	26	980	7	DIT-LG	423-0007-033
175	223-0031-655	423-6SLG-000	46	35	30	1200	7	DIT-LG	423-0007-035
220	223-0032-655	423-6TLG-000	46	35	30	1380	7	DIT-LG	423-0007-035
275	223-0033-655	423-6ULG-000	46	35	30	1590	7	DIT-LG	423-0007-035
330	223-0034-655	423-6VLG-000	60	48	33	1680	7	DIT-LG	423-0007-048
440	223-0035-655	423-6WLG-000	60	48	33	2030	7	DIT-LG	423-0007-048
550	223-0036-655	423-6XLG-000	60	48	33	2530	7	DIT-LG	423-0007-048

Date Dec 09



Version JE901.1209 Date Dec 09

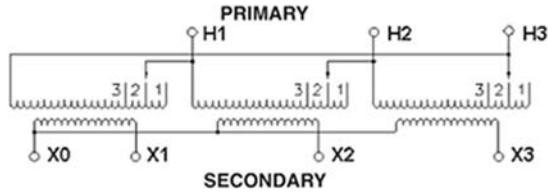
7

Drive Isolation

DIT CC Wiring Diagram & Connections

Wiring Diagram

Primary: 230 Secondary: 230Y/133 Volts



Connections

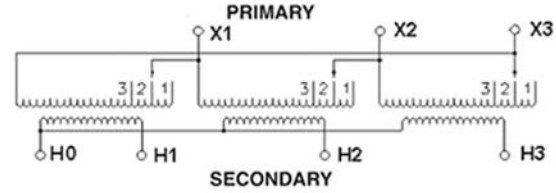
Primary Volts	On Each Coil Jumper Taps To	Primary Lines Connect To
242	1	H1, H2, H3
230	2	H1, H2, H3
218	3	H1, H2, H3
Sec. Volts	Secondary Lines Connect To	
230	X1, X2, X3	
133	Between X0 and X1 or X2 or X3	

1 Phase

DIT CG Wiring Diagram & Connections

Wiring Diagram

Primary: 230 Secondary: 460Y/266 Volts



Connections

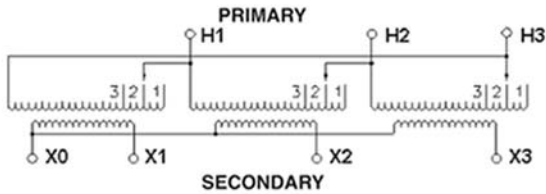
Primary Volts	On Each Coil Jumper Taps To	Primary Lines Connect To
242	1	X1, X2, X3
230	2	X1, X2, X3
218	3	X1, X2, X3
Sec. Volts	Secondary Lines Connect To	
460	H1, H2, H3	
266	Between H0 and H1 or H2 or H3	

1 Phase

DIT GC Wiring Diagram & Connections

Wiring Diagram

Primary: 460 Secondary: 230Y/133 Volts



Connections

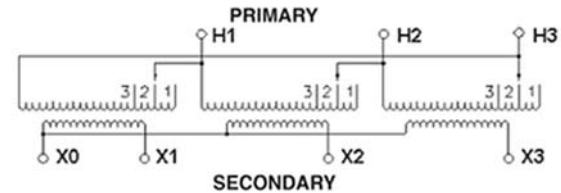
Primary Volts	On Each Coil Jumper Taps To	Primary Lines Connect To
483	1	H1, H2, H3
460	2	H1, H2, H3
437	3	H1, H2, H3
Sec. Volts	Secondary Lines Connect To	
230	X1, X2, X3	
133	Between X0 and X1 or X2 or X3	

1 Phase

DIT GG Wiring Diagram & Connections

Wiring Diagram

Primary: 460 Secondary: 460Y/266 Volts



Connections

Primary Volts	On Each Coil Jumper Taps To	Primary Lines Connect To
483	1	H1, H2, H3
460	2	H1, H2, H3
437	3	H1, H2, H3
Sec. Volts	Secondary Lines Connect To	
460	X1, X2, X3	
266	Between X0 and X1 or X2 or X3	

NOTE: Electrostatic shields are optionally available and not shown in all wiring diagrams. * Insulate unused taps individually.

Date Dec 09

Version JE901 1209

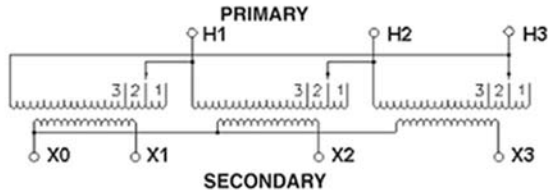
Version

7

Drive Isolation

DITLC Wiring Diagram & Connections

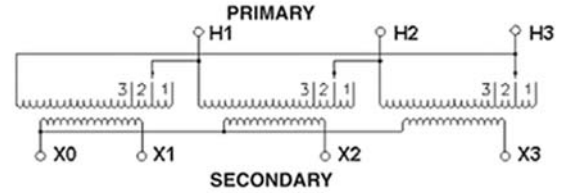
Wiring Diagram	
Primary: 575	Secondary: 230Y/133 Volts



Connections		
Primary Volts	On Each Coil Jumper Taps To	Primary Lines Connect To
604	1	H1, H2, H3
575	2	H1, H2, H3
546	3	H1, H2, H3
Sec. Volts	Secondary Lines Connect To	
230	X1, X2, X3	
133	Between X0 and X1 or X2 or X3	

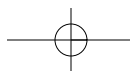
DITLG Wiring Diagram & Connections

Wiring Diagram	
Primary: 575	Secondary: 460Y/266 Volts



Connections		
Primary Volts	On Each Coil Jumper Taps To	Primary Lines Connect To
604	1	H1, H2, H3
575	2	H1, H2, H3
546	3	H1, H2, H3
Sec. Volts	Secondary Lines Connect To	
460	X1, X2, X3	
266	Between X0 and X1 or X2 or X3	

NOTE: Electrostatic shields are optionally available and not shown in all wiring diagrams. * Insulate unused taps individually.



Non-Linear Three-Phase – Jefferson® Plus

8



15 to 500 KVA

Contents

Overview	8.2
Dimensional Drawings	8.7
Wiring Diagrams	8.8
Selection Charts	
208 V - 208Y/120 V	8.5
208 V - 480Y/277 V	8.5
240 V - 208Y/120 V	8.5
240 V - 480Y/277 V	8.5
480 V - 208Y/120 V	8.5
480 V - 480Y/277 V	8.6
600 V - 208Y/120 V	8.6
Suffix Chart	8.6

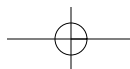
Version JE901 0809 Date Sept 08



1-800-892-3755 www.jeffersonelectric.com

Dry-Type Transformers

8.1



8

Non-Linear Three-Phase – Jefferson® Plus

Products

- 15 KVA through 500 KVA*

Applications

- For electronic loads to meet non-linear load demands caused by modern office equipment
- For indoor/outdoor applications

Specifications

- K-4, K-13, and K-20 rated units standard*
- Meets Federally Mandated NEMA TP-1 Standard for energy efficiency
- Cores of high quality electrical steel
- Cores designed for reduced flux densities to compensate for harmonic voltage distortion
- NEMA 1-rated enclosures standard
- Aluminum or copper windings
- Electrostatically shielded
- 220°C insulation class standard
- 150°C, 115°C, and 80°C temperature rise
- Heat-cured ASA-61 gray powder coat finish

Features, Functions, Benefits

- Designed with lower weight and smaller size for easier handling and installation
- Large connection compartment for ease of wiring and installation
- Quiet operation for installation flexibility
- Hassle-free front cover installation
- Taps provided on primary to compensate for voltage variations

Standards

- Built in accordance with NEMA, ANSI, UL and CSA standards

*Options and Accessories

- CE Marked units available
- Other sizes, voltages, and connections available as custom
- Other K-factor rated units available as custom
- NEMA 3R-rated weather shields available
- Wall mount brackets available

Version JE901 0809 Date Sept 08

Non-Linear Three-Phase – Jefferson® Plus

Transformers for today's electronic environment

These transformers are designed to meet the non-linear load demands caused by computers and other modern electronic equipment. These types of loads can cause severe overheating in distribution transformers designed to meet the needs of a pre-electronic era. The Jefferson® Plus™ line of non-linear transformers provides safe and efficient operation in non-linear load environments.

The K-factor

The K-factor is a rating devised by Underwriters Laboratories to provide uniform standards for transformers designed to handle non-linear loads. The more odd-harmonic currents present, the higher the K-factor specified in sizing the transformer.

To calculate the K-factor, multiply the square of the percentage of harmonic current by the square of the harmonic order and add the results. For example, if a load is 60% of the fundamental, 65% of the third harmonic, 30% of the fifth harmonic, and 35% of the seventh harmonic, the resulting K-factor would be 12.42:

$$(.6)^2 1 + (.65)^2(3)^2 + (.30)^2(5)^2 + (.35)^2(7)^2 = 12.42$$

In this example, a transformer with a K-factor of 13 should be specified. The K-factor rating defines the transformer's ability to withstand odd-harmonic currents while operating within its insulation class.

When the K-factor is unknown, a transformer may be selected by using the table to the right as a guide.

K-FACTOR	TYPE OF LOAD
K-1	Resistance heating Incandescent lighting Motors Transformers • Control • Distribution
K-4	Welders Induction heaters HID lighting Fluorescent lighting Solid state controls
K-13	Telecommunications equipment Branch circuits in classrooms and healthcare facilities
K-20	Mainframe computers Variable speed drives Branch circuits with exclusive loads of data processing equipment

Version JE901 0809 Date Sept 08



8

Non-Linear Three-Phase – Jefferson® Plus

Why Your Existing Transformer May Be Inadequate

Traditional transformers were designed to handle the purely resistive electrical loads created mainly by standard lighting and motors. The currents drawn by these loads are sinusoidal in shape, as is the waveshape of the supply voltage. When the loads are linear and balanced as in a typical three-phase system, the neutral current flow is zero. This is because the three-phase currents are 120 degrees out of phase with each other and cancel in the neutral. The sinusoidal current waveshape is the foundation for wire-size calculations, for determining how to balance loads to reduce neutral currents, and for subsequently reducing the size of neutral conductors to reduce material costs.

The Phenomenon of Odd Harmonics

The switched mode power supply (SMPS) current drawn by electronic equipment bears little resemblance to the current drawn by purely resistive loads. Instead of the traditional sinusoidal waveform, SMPS current waveforms occur in sharp bursts. This irregularity of the SMPS waveform produces a non-linear load as opposed to the linear load produced by the sinusoidal waveform. Non-linear loads on the other hand, are rich in odd harmonics, which are multiples of the fundamental 60 Hertz frequency. The major components of harmonic currents in switched mode power supplies are the third and fifth harmonics. Non-linear, off-harmonic current components become additive in the neutral and can result in a neutral current as much as double the phase current, even in a balanced system.

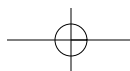
How Harmonics Affect Transformers

When these odd-harmonic currents are present, winding losses increase. The I^2R or conductor losses are higher because harmonics increase the current. Stray losses in windings also increase because of additional eddy currents circulating within the conductors. The combination of these additional losses generate excessive heat in the transformer coils. Transformer insulation systems are designed to accommodate temperature increases due to normal stray losses. However, when required to carry non-linear loads, the heat generated exceeds the designed rating, reducing the life of the transformer and creating the possibility of premature failure.

De-rating is Not the Answer

De-rating a traditional linear transformer to compensate for heat build-up requires higher installation costs, provides poor energy efficiency due to increased core losses, and leaves a system that will become increasingly obsolete.

Version JE901 0809 Date Sept 08



Non-Linear Three-Phase – Jefferson® Plus

K-4 Three-Phase

150°C Temperature Rise • Electrostatic Shield

Taps: 15 to 112.5 KVA 2@ 2.5% FCAN & 4@ 2.5% FCBN
150 to 300 KVA 1@ 5% FCAN & 2@ 5% FCBN

KVA	Catalog Number*	Fig.	Height A (in.)	Width B (in.)	Depth C (in.)	Est. Ship Wgt. (lbs.)	Wiring Diagram	Weather Shield Kit	Wall Bracket Kit
208 V - 208Y/120 V – Aluminum windings*									
15	424-7168-001	7	22.0	19.0	16.0	295	T208B	423-0007-019	223-7008-030
30	424-7198-001	7	25.0	22.0	17.0	385		423-0007-022	223-7008-075
45	424-7218-001	7	28.0	25.0	18.5	565		423-0007-025	
75	424-7238-001	7	32.0	27.0	21.0	750		423-0007-027	
112.5	424-7258-001	7	38.0	29.0	23.0	960	T208F	423-0007-029	N/A
150	424-7268-001	7	42.0	33.0	26.0	1280		423-0007-033	
225	424-7298-001	7	46.0	35.0	30.0	1645		423-0007-035	
300	424-7318-001	7	52.0	35.0	30.0	1660		423-0007-035	
500	424-7348-001	7	60.0	48.0	33.0	2460		423-0007-048	

208 V - 480Y/277 V – Aluminum windings*									
15	424-7161-001	7	22.0	19.0	16.0	295	T208D	423-0007-019	223-7008-030
30	424-7191-001	7	25.0	22.0	17.0	385		423-0007-022	223-7008-075
45	424-7211-001	7	28.0	25.0	18.5	565		423-0007-025	
75	424-7231-001	7	32.0	27.0	21.0	750		423-0007-027	
112.5	424-7251-001	7	38.0	29.0	23.0	960	T208G	423-0007-029	N/A
150	424-7261-001	7	42.0	33.0	26.0	1280		423-0007-033	
225	424-7291-001	7	46.0	35.0	30.0	1645		423-0007-035	
300	424-7311-001	7	52.0	35.0	30.0	1660		423-0007-035	
500	424-7341-001	7	60.0	48.0	33.0	2460		423-0007-048	

240 V - 208Y/120 V – Aluminum windings*									
15	424-7162-001	7	22.0	19.0	16.0	295	T240B	423-0007-019	223-7008-030
30	424-7192-001	7	25.0	22.0	17.0	385		423-0007-022	223-7008-075
45	424-7212-001	7	28.0	25.0	18.5	565		423-0007-025	
75	424-7232-001	7	32.0	27.0	21.0	750		423-0007-027	
112.5	424-7252-001	7	38.0	29.0	23.0	960	T240F	423-0007-029	N/A
150	424-7262-001	7	42.0	33.0	26.0	1280		423-0007-033	
225	424-7292-001	7	46.0	35.0	30.0	1645		423-0007-035	
300	424-7312-001	7	52.0	35.0	30.0	1660		423-0007-035	
500	424-7342-001	7	60.0	48.0	33.0	2460		423-0007-048	

240 V - 480Y/277 V – Aluminum windings*									
15	424-7163-001	7	22.0	19.0	16.0	295	T240D	423-0007-019	223-7008-030
30	424-7193-001	7	25.0	22.0	17.0	385		423-0007-022	223-7008-075
45	424-7213-001	7	28.0	25.0	18.5	565		423-0007-025	
75	424-7233-001	7	32.0	27.0	21.0	750		423-0007-027	
112.5	424-7253-001	7	38.0	29.0	23.0	960	T240E	423-0007-029	N/A
150	424-7263-001	7	42.0	33.0	26.0	1280		423-0007-033	
225	424-7293-001	7	46.0	35.0	30.0	1645		423-0007-035	
300	424-7313-001	7	52.0	35.0	30.0	1660		423-0007-035	
500	424-7343-001	7	60.0	48.0	33.0	2460		423-0007-048	

480 V - 208Y/120 V – Aluminum windings*									
15	424-7164-001	7	22.0	19.0	16.0	295	T480E	423-0007-019	223-7008-030
30	424-7194-001	7	25.0	22.0	17.0	385		423-0007-022	223-7008-075
45	424-7214-001	7	28.0	25.0	18.5	565		423-0007-025	
75	424-7234-001	7	32.0	27.0	21.0	750		423-0007-027	
112.5	424-7254-001	7	38.0	29.0	23.0	960		423-0007-029	N/A
150	424-7264-001	7	42.0	33.0	26.0	1280		423-0007-033	
225	424-7294-001	7	46.0	35.0	30.0	1645		423-0007-035	
300	424-7314-001	7	52.0	35.0	30.0	1660		423-0007-035	
500	424-7344-001	7	60.0	48.0	33.0	2460	423-0007-048		

* For copper and/or low temp rise K-13 or K-20 units see suffix chart on page 8.6

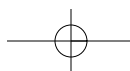
Note: Housing dimensions subject to change without notice. Consult website or factory where dimensions are critical.



1-800-892-3755 www.jeffersonelectric.com

Dry-Type Transformers

8.5



8

Non-Linear Three-Phase – Jefferson® Plus

K-4 Three-Phase

150°C Temperature Rise • Electrostatic Shield, Taps: 2@ 2.5% FCAN & 4@ 2.5% FCBN

KVA	Catalog Number*	Fig.	Height A (in.)	Width B (in.)	Depth C (in.)	Est. Ship Wgt. (lbs.)	Wiring Diagram	Weather Shield Kit	Wall Bracket Kit
480 V - 480Y/277 V – Aluminum windings*									
15	424-7165-001	7	22.0	19.0	16.0	295	T480J	423-0007-019	223-7008-030
30	424-7195-001	7	25.0	22.0	17.0	385		423-0007-022	223-7008-075
45	424-7215-001	7	28.0	25.0	18.5	565		423-0007-025	
75	424-7235-001	7	32.0	27.0	21.0	750		423-0007-027	
112.5	424-7255-001	7	38.0	29.0	23.0	960		423-0007-029	N/A
150	424-7265-001	7	42.0	33.0	26.0	1280		423-0007-033	
225	424-7295-001	7	46.0	35.0	30.0	1645		423-0007-035	
300	424-7315-001	7	52.0	35.0	30.0	1660		423-0007-035	
500	424-7345-001	7	60.0	48.0	33.0	2460		423-0007-048	

600 V - 208Y/120 V – Aluminum windings*									
15	424-7169-001	7	22.0	19.0	16.0	295	T600B	423-0007-019	223-7008-030
30	424-7199-001	7	25.0	22.0	17.0	385		423-0007-022	223-7008-075
45	424-7219-001	7	28.0	25.0	18.5	565		423-0007-025	
75	424-7239-001	7	32.0	27.0	21.0	750		423-0007-027	
112.5	424-7259-001	7	38.0	29.0	23.0	960		423-0007-029	N/A
150	424-7269-001	7	42.0	33.0	26.0	1280		423-0007-033	
225	424-7299-001	7	46.0	35.0	30.0	1645		423-0007-035	
300	424-7319-001	7	60.0	48.0	33.0	2460		423-0007-035	
500	424-7349-001	7	60.0	48.0	33.0	2460		423-0007-048	

* For copper and/or low temp rise K-13 or K-20 units see suffix chart on page 8.6

Suffix Chart

The catalog number on the standard Non-Linear products have a suffix of -001 for K-4, -002 for K-13, -003 for K-20.

To order alternate version transformers choose the suffix to match the desired features.

Suffix	Wire	Temperature Rise	K-Factor
001	Aluminum	150	K-4
011	Aluminum	115	K-4
081	Aluminum	80	K-4
801	Copper	150	K-4
811	Copper	115	K-4
881	Copper	80	K-4
002	Aluminum	150	K-13
012	Aluminum	115	K-13
082	Aluminum	80	K-13
802	Copper	150	K-13
812	Copper	115	K-13
882	Copper	80	K-13
003	Aluminum	150	K-20
013	Aluminum	115	K-20
083	Aluminum	80	K-20
803	Copper	150	K-20
813	Copper	115	K-20
883	Copper	80	K-20

Note: The weight, dimensions, weather shield and mounting brackets may be different than the standard version.

Check our website www.jeffersonelectric.com for details



Note: Housing dimensions subject to change without notice. Consult website or factory where dimensions are critical.



Non-Linear Three-Phase – Jefferson® Plus

Figure 7

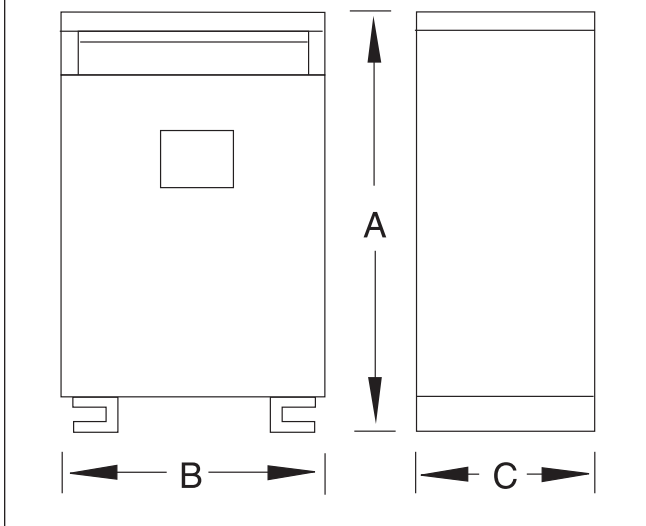
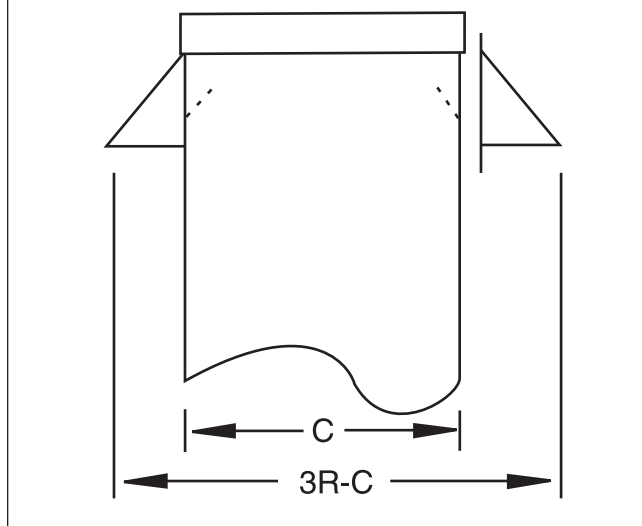


Figure 8



Weather Shield Kit to Make Enclosures NEMA 3R Rated

kVA*	Part Number	Width (B)	Depth w/o weather shield (C)	Depth with weather shield (3R-C)	Shipping weight (lbs.)
15	423-0007-019	19.0	16.0	23.0	3.2
30	423-0007-022	22.0	17.0	24.0	3.6
45	423-0007-025	25.0	18.5	25.5	4.1
75	423-0007-027	27.0	21.0	28.0	4.4
112.5	423-0007-029	29.0	23.0	31.0	5.3
150	423-0007-033	33.0	26.0	34.0	6.3
225	423-0007-035	35.0	30.0	38.0	6.7
300	423-0007-035	35.0	30.0	38.0	6.7
500	423-0007-048	48.0	33.0	43.5	12.2

*kVA for 150 degree rise and K-4 units

Mounting Brackets

Part Number	Description	Shipping weight (lbs.)
223-7008-030	For 15 KVA unit at 150 degree C rise	18
223-7008-075	For 16 to 75 KVA unit at 150 degree C rise	20

Version JE901 0809 Date Feb 09



1-800-892-3755 www.jeffersonelectric.com

Dry-Type Transformers

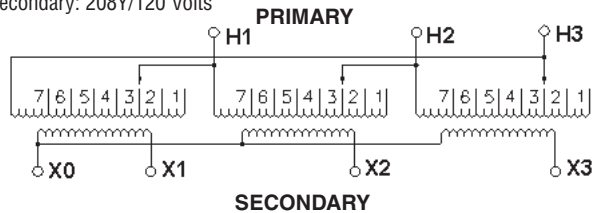
8

Non-Linear Three-Phase – Jefferson® Plus

T208B Wiring Diagram & Connections*

Wiring Diagram

Primary: 208 Volts Delta
Secondary: 208Y/120 Volts

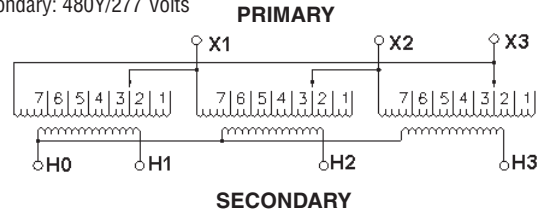


Connections		
Primary Volts	On Each Coil Jumper Taps To	Primary Lines Connect To
218	1	H1, H2, H3
213	2	H1, H2, H3
208	3	H1, H2, H3
203	4	H1, H2, H3
198	5	H1, H2, H3
192	6	H1, H2, H3
187	7	H1, H2, H3
Sec. Volts	Secondary Lines Connect To	
208	X1, X2, X3	
120	Between X0 and X1 or X2 or X3	
1 Phase		

T208D Wiring Diagram & Connections*

Wiring Diagram

Primary: 208 Volts Delta
Secondary: 480Y/277 Volts

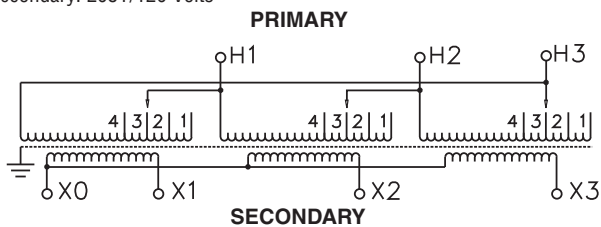


Connections		
Primary Volts	On Each Coil Jumper Taps To	Primary Lines Connect To
218	1	X1, X2, X3
213	2	X1, X2, X3
208	3	X1, X2, X3
203	4	X1, X2, X3
198	5	X1, X2, X3
192	6	X1, X2, X3
187	7	X1, X2, X3
Sec. Volts	Secondary Lines Connect To	
480	H1, H2, H3	
277	Between H0 and H1 or H2 or H3	
1 Phase		

T208F Wiring Diagram & Connections*

Wiring Diagram

Primary: 208 Volts Delta
Secondary: 208Y/120 Volts

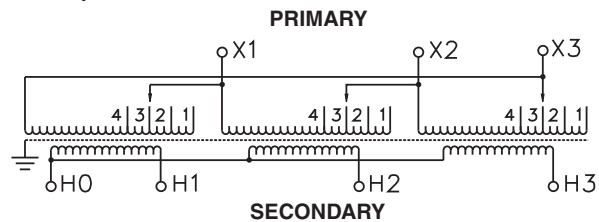


Connections		
Primary Volts	On Each Coil Jumper Taps To	Primary Lines Connect To
218	1	H1, H2, H3
208	2	H1, H2, H3
198	3	H1, H2, H3
187	4	H1, H2, H3
Sec. Volts	Secondary Lines Connect To	
208	X1, X2, X3	
120	Between X0 and X1 or X2 or X3	
1 Phase		

T208G Wiring Diagram & Connections*

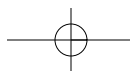
Wiring Diagram

Primary: 208 Volts Delta
Secondary: 480Y/277 Volts



Connections		
Primary Volts	On Each Coil Jumper Taps To	Primary Lines Connect To
218	1	X1, X2, X3
208	2	X1, X2, X3
198	3	X1, X2, X3
187	4	X1, X2, X3
Sec. Volts	Secondary Lines Connect To	
480	H1, H2, H3	
277	Between H0 and H1 or H2 or H3	
1 Phase		

NOTE: Electrostatic shields are optionally available and not shown in all wiring diagrams. * Insulate unused taps individually.

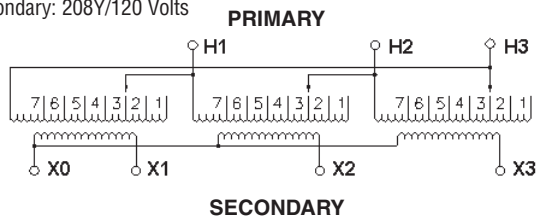


Non-Linear Three-Phase – Jefferson® Plus

T240B Wiring Diagram & Connections*

Wiring Diagram

Primary: 240 Volts Delta
Secondary: 208Y/120 Volts

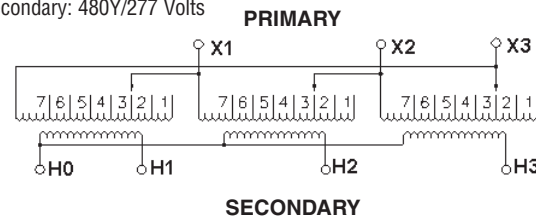


Primary Volts	On Each Coil Jumper Taps To	Primary Lines Connect To
252	1	H1, H2, H3
246	2	H1, H2, H3
240	3	H1, H2, H3
234	4	H1, H2, H3
228	5	H1, H2, H3
222	6	H1, H2, H3
216	7	H1, H2, H3
Sec. Volts	Secondary Lines Connect To	
208	X1, X2, X3	
120	Between X0 and X1 or X2 or X3	
1 Phase		

T240D Wiring Diagram & Connections*

Wiring Diagram

Primary: 240 Volts Delta
Secondary: 480Y/277 Volts

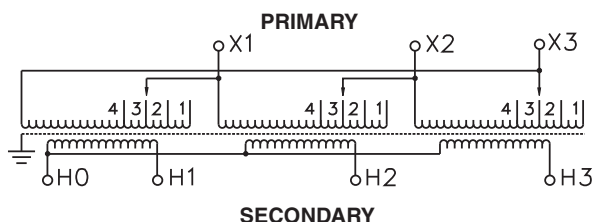


Primary Volts	On Each Coil Jumper Taps To	Primary Lines Connect To
252	1	X1, X2, X3
246	2	X1, X2, X3
240	3	X1, X2, X3
234	4	X1, X2, X3
228	5	X1, X2, X3
222	6	X1, X2, X3
216	7	X1, X2, X3
Sec. Volts	Secondary Lines Connect To	
480	H1, H2, H3	
277	Between H0 and H1 or H2 or H3	
1 Phase		

T240E Wiring Diagram & Connections*

Wiring Diagram

Primary: 240 Volts Delta
Secondary: 480Y/277 Volts

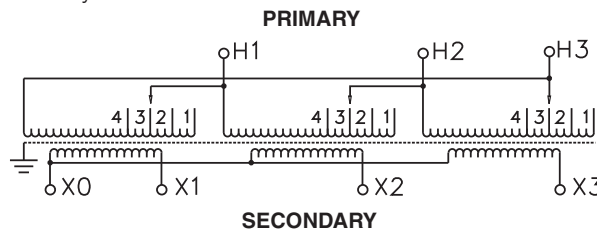


Primary Volts	On Each Coil Jumper Taps To	Primary Lines Connect To
252	1	X1, X2, X3
240	2	X1, X2, X3
228	3	X1, X2, X3
216	4	X1, X2, X3
Sec. Volts	Secondary Lines Connect To	
480	H1, H2, H3	
277	Between H0 and H1 or H2, or H3	
1 Phase		

T240F Wiring Diagram & Connections*

Wiring Diagram

Primary: 240 Volts Delta
Secondary: 208Y/120 Volts



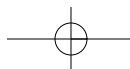
Primary Volts	On Each Coil Jumper Taps To	Primary Lines Connect To
252	1	H1, H2, H3
240	2	H1, H2, H3
228	3	H1, H2, H3
216	4	H1, H2, H3
Sec. Volts	Secondary Lines Connect To	
208	X1, X2, X3	
120	Between X0 and X1 or X2, or X3	
1 Phase		

NOTE: Electrostatic shields are optionally available and not shown in all wiring diagrams. * Insulate unused taps individually.



1-800-892-3755 www.jeffersonelectric.com

Dry-Type Transformers



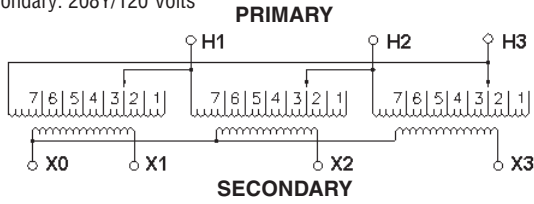
8

Non-Linear Three-Phase – Jefferson® Plus

T480E Wiring Diagram & Connections*

Wiring Diagram

Primary: 480 Volts Delta
Secondary: 208Y/120 Volts



SECONDARY

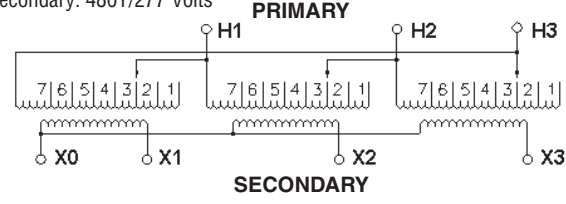
Connections

Primary Volts	On Each Coil Jumper Taps To	Primary Lines Connect To
504	1	H1, H2, H3
492	2	H1, H2, H3
480	3	H1, H2, H3
468	4	H1, H2, H3
456	5	H1, H2, H3
444	6	H1, H2, H3
432	7	H1, H2, H3
Sec. Volts	Secondary Lines Connect To	
208	X1, X2, X3	
120	Between X0 and X1 or X2 or X3	
1 Phase		

T480J Wiring Diagram & Connections*

Wiring Diagram

Primary: 480 Volts Delta
Secondary: 480Y/277 Volts



SECONDARY

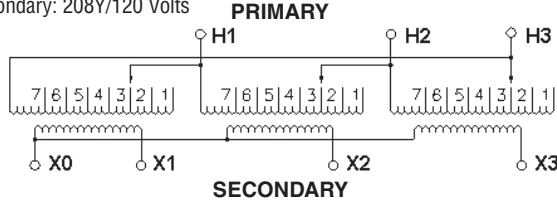
Connections

Primary Volts	On Each Coil Jumper Taps To	Primary Lines Connect To
504	1	H1, H2, H3
492	2	H1, H2, H3
480	3	H1, H2, H3
468	4	H1, H2, H3
456	5	H1, H2, H3
444	6	H1, H2, H3
432	7	H1, H2, H3
Sec. Volts	Secondary Lines Connect To	
480	X1, X2, X3	
277	Between X0 and X1 or X2 or X3	
1 Phase		

T600B Wiring Diagram & Connections*

Wiring Diagram

Primary: 600 Volts
Secondary: 208Y/120 Volts



SECONDARY

Connections

Primary Volts	On Each Coil Jumper Taps To	Primary Lines Connect To
630	1	H1, H2, H3
615	2	H1, H2, H3
600	3	H1, H2, H3
585	4	H1, H2, H3
570	5	H1, H2, H3
555	6	H1, H2, H3
540	7	H1, H2, H3
Sec. Volts	Secondary Lines Connect To	
208	X1, X2, X3	
120	Between X0 and X1 or X2 or X3	
1 Phase		

NOTE: Electrostatic shields are optionally available and not shown in all wiring diagrams. * Insulate unused taps individually.

Buck-Boost – Powerformer™

9



0.050 to 10 KVA

Contents

Overview	9.2
Dimensional Drawings	9.9
Wiring Diagrams	9.10
Selection Charts	
120 x 240 V – 12/24 V 60 Hz	9.8
120 x 240 V – 16/32 V 60 Hz	9.8
240 x 480 V – 24/48 V 60 Hz	9.8

Version JE901 0809 Date Sept 08



1-800-892-3755

www.jeffersonelectric.com

Dry-Type Transformers

9.1

9

Buck-Boost – Powerformer™

Products

- *Single-Phase Encapsulated: 50 VA through 10 KVA**

Applications

- *For correcting voltage line drops, landscape lighting, low voltage lighting, international voltage adaptation and motor applications*
- *Note: Buck-boost transformers do not compensate for fluctuating line voltages.*

Specifications

- *Encapsulated with electrical grade resin*
- *Cores of high quality electrical steel*
- *NEMA 3R-rated enclosures*
- *135°C temperature rise, 180°C insulation class or 95°C temperature rise, 130°C insulation class depending on kVA size*
- *Heat-cured ASA-61 gray powder coat finish*

Features, Functions, Benefits

- *Slotted mounting holes for quick and easy mounting*
- *Convenient wall mount design with lifting hooks above 5 KVA*
- *Permanently affixed wiring diagram*

Standards

- *Built in accordance with NEMA, ANSI, UL and CSA standards*

*Options and Accessories

- *CE Marked units available as custom*
- *Other sizes and voltages available as custom*

Version JE901 0809 Date Sept 08

Buck-Boost – Powerformer™

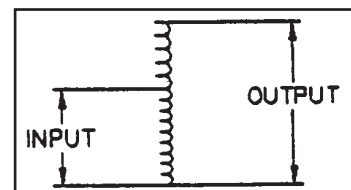
Jefferson Electric single-phase Buck-Boost transformers are the most economical means available for stepping voltages up or down in many common applications. They can be used as isolating (or insulating) transformers for transforming standard line voltages to low secondary voltages. They are also used to buck or boost off-standard line voltages to satisfy standard load voltage requirements when connected in an autotransformer configuration.

These transformers are designed for use on single- or three-phase circuits to supply 12/24 or 16/32 volt secondaries with 120/240 volt primary, and 24/48 volt secondaries with 240/480 volt primary. When connected in an autotransformer configuration, these small, compact and lightweight units will handle a large KVA load in comparison to their physical size and relative cost. When used as isolation transformers, they have innumerable low voltage applications.

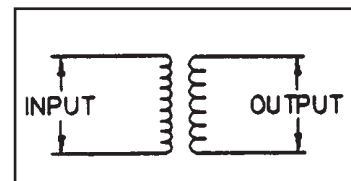
The difference between an autotransformer and an isolation transformer.

In an autotransformer, the input (or primary) and the output (or secondary) are electrically connected, while in an isolation transformer they are completely separated, as shown to the right.

Only a portion of the electrical energy is changed in an autotransformer, the remainder flowing directly between the primary and secondary. In an isolation transformer, all the energy is transformed. For these reasons, an autotransformer is smaller, lighter and less costly than a comparable isolation transformer.



Autotransformer



Isolation (or Insulating) Transformer

Solve over/under line voltage problems efficiently and economically.

Electrical equipment is manufactured to operate most efficiently when the line voltage is equal to or nearly equal to the nameplate rating of the equipment. A motor operated at a voltage substantially under its nameplate rating may run constantly on the starting windings, resulting in overheating and possible burn-out. The same motor operated at a voltage substantially over its nameplate rating is subject to excessive heat rise, often extending beyond the insulation temperature limits, which may eventually cause the motor to burn out.

Caution: Buck-Boost transformers will not compensate for fluctuating line voltages. They should only be used when line voltage is relatively constant.

9

Buck-Boost – Powerformer™

How to Use the Buck-Boost Rapid Selector Charts:

You will need the following information:

Line voltage:

This can be determined by measuring the supply line voltage with a voltmeter.

Load voltage:

The voltage at which your equipment was designed to operate. Usually listed on the equipment nameplate.

Load KVA or load amps:

One of these will usually be listed on the nameplate. You do not need both.

Supply line and equipment frequencies:

This will be either 50 or 60 cycles. The supply line frequency must be the same as the frequency of the equipment to be operated.

Supply line and equipment phase:

Either single-phase or three-phase. The line phase must be the same as the equipment.

The type of electrical configuration:

Delta or Wye.

Follow These Five Easy Steps:

1. Find the appropriate single-phase, three-phase delta or three-phase wye table.
2. Read down the voltage column and find the nearest ratio of required load voltage to line voltage for the application desired. (High and low voltage may be either input or output voltage depending on the circumstances.)
3. Reading horizontally across the line beginning with your application voltage ratio, locate in one of the KVA columns a KVA capacity equal to or larger than your load requirement.
4. Note the two digit number at the top of the KVA column listing the KVA capacity you require.
5. In the catalog number column, add these two digits to the catalog number next to the voltage ratio you found in step one.

Example:

(Assume the following information)

1. A reasonably constant line voltage of 440 volts.
2. A required equipment voltage of 480 volts.
3. 26.0 KVA load capacity needed.
4. Single-phase line and equipment.

In the voltage column, 437 is closest to our line voltage of 440. The 480 high voltage meets our requirements exactly.

Reading horizontally across this line, find 30.0 KVA, the closest larger KVA to our required 26.0.

Going to the very top of this column, take the two digit number, 81, and add it on the end of the catalog number on the same line as our high/low voltage. The catalog number 416-14, with 81 added on the end, is 416-1481.

The listings here do not cover all the possible applications of these versatile transformers. Please call for advice or a quotation on special applications.

Version JE901 0809 Date Sept 08

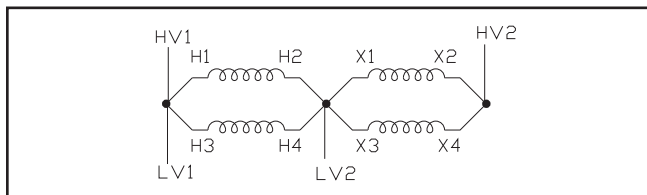
Buck-Boost – Powerformer™

Single-Phase KVA Capacity of Encapsulated Powerformers™ Maximum load capabilities

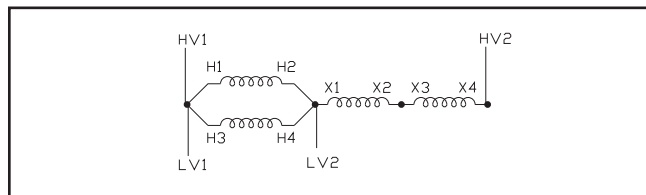
Low Voltage (LV)	High Voltage (HV)	Catalog Number	Load Required*	01 .100 KVA	11 .150 KVA	21 .250 KVA	31 .500 KVA	41 .750 KVA	51 1.0 KVA	61 1.5 KVA	71 2.0 KVA	81 3.0 KVA	91 5.0 KVA	Wiring Diagram
95	120	416-12	KVA	.37	.56	.94	1.8	2.8	3.7	5.6	7.5	11.2	18.8	2
			AMPS	3.95	5.93	9.89	19.7	29.6	39.5	59.3	79.1	118	197	
100	120	416-11	KVA	.50	.75	1.25	2.50	3.7	5.0	7.5	10.0	15.0	25.0	2
			AMPS	5.0	7.5	12.5	25.0	37.0	50.0	75.0	100	150	250	
106	120	416-12	KVA	.75	1.12	1.87	3.7	5.6	7.5	11.2	15.0	22.5	37.0	1
			AMPS	7.07	10.5	17.6	34.9	52.8	70.7	105	141	212	349	
109	120	416-11	KVA	1.00	1.50	2.50	5.0	7.5	10.0	15.0	20.0	30.0	50.0	1
			AMPS	9.17	13.7	22.9	45.8	68.8	91.7	137	183	275	458	
120	132	416-11	KVA	1.10	1.65	2.75	5.5	8.2	11.0	16.5	22.0	33.0	55.0	1
			AMPS	9.17	13.7	22.9	45.8	68.8	91.7	137	183	275	458	
120	136	416-12	KVA	.85	1.27	2.12	4.2	6.3	8.5	12.7	17.0	25.5	42.0	1
			AMPS	7.08	10.5	17.6	35.0	52.5	70.8	105	141	212	350	
120	144	416-11	KVA	.60	.90	1.50	3.0	4.5	6.0	9.0	12.0	18.0	30.0	2
			AMPS	5.0	7.5	12.5	25.0	37.5	50.0	75.0	100	150	250	
120	152	416-12	KVA	.47	.71	1.18	2.3	3.5	4.7	7.1	9.5	14.2	23.0	2
			AMPS	3.91	5.91	9.83	19.1	29.1	39.1	59.1	79.1	118	191	
200	240	416-14	KVA	.50	.75	1.25	2.5	3.7	5.0	7.5	10.0	15.0	25.0	2
			AMPS	2.50	3.75	6.25	12.5	18.7	25.0	37.5	50.0	75.0	125	
208	236	416-12	KVA	.73	1.10	1.84	3.6	5.5	7.3	11.0	14.7	22.1	36.8	4
			AMPS	3.53	5.28	8.82	17.4	26.4	35.3	52.8	70.7	106	174	
212	240	416-12	KVA	.75	1.12	1.87	3.7	5.6	7.5	11.2	15.0	22.5	37.0	4
			AMPS	3.53	5.28	8.82	17.4	26.4	35.3	52.8	70.7	106	174	
208	230	416-11	KVA	.95	1.4	2.3	4.7	7.1	9.5	14.3	19.0	28.6	47.6	4
			AMPS	4.58	6.88	11.4	22.9	34.4	45.8	68.8	91.7	137	229	
218	240	416-11	KVA	1.00	1.5	2.5	5.0	7.5	10.0	15.0	20.0	30.0	50.0	4
			AMPS	4.58	6.88	11.4	22.9	34.4	45.8	68.8	91.7	137	229	
225	240	416-12	KVA	1.5	2.25	3.75	7.5	11.2	15.0	22.5	30.0	45.0	75.0	3
			AMPS	6.66	10.0	16.6	33.3	49.7	66.6	100	133	200	333	
230	276	416-14	KVA	.57	.86	1.43	2.8	4.3	5.7	8.6	11.5	17.2	28.7	2
			AMPS	2.50	3.75	6.25	12.5	18.7	25.0	37.5	50.0	75.0	124	
240	252	416-11	KVA	2.1	3.15	5.25	10.5	15.7	21.0	31.5	42.0	63.0	105	3
			AMPS	8.75	13.1	21.8	43.7	65.4	87.5	131	175	262	437	
240	264	416-11	KVA	1.1	1.65	2.75	5.5	8.2	11.0	16.5	22.0	33.0	55.0	4
			AMPS	4.58	6.87	11.4	22.9	34.1	45.8	68.7	91.6	137	229	
240	272	416-12	KVA	.85	1.27	2.12	4.2	6.3	8.5	12.7	17.0	25.5	42.0	4
			AMPS	3.54	5.29	8.83	17.5	26.2	35.4	52.9	70.8	106	175	
240	288	416-14	KVA	.60	.90	1.50	3.0	4.5	6.0	9.0	12.0	18.0	30.0	2
			AMPS	2.5	3.75	6.25	12.5	18.7	25.0	37.5	50.0	75.0	125	
437	480	416-14	KVA	1.00	1.50	2.50	5.0	7.5	10.0	15.0	20.0	30.0	50.0	4
			AMPS	2.28	3.43	5.72	11.4	17.1	22.8	34.3	45.7	68.6	114	
457	480	416-14	KVA	2.0	3.0	5.0	10.0	15.0	20.0	30.0	40.0	60.0	100	3
			AMPS	4.37	6.56	10.9	21.8	32.8	43.7	65.6	87.5	131	218	
480	504	416-14	KVA	2.1	3.15	5.25	10.5	15.7	21.0	31.5	42.0	63.0	105	3
			AMPS	4.37	6.56	10.9	21.8	32.8	43.7	65.6	87.5	131	218	
480	528	416-14	KVA	1.1	1.65	2.75	5.5	8.2	11.0	16.5	22.0	33.0	55.0	4
			AMPS	2.29	3.43	5.72	11.4	17.0	22.9	34.3	45.8	68.7	114	

* Load required is calculated based on the low voltage as the load.

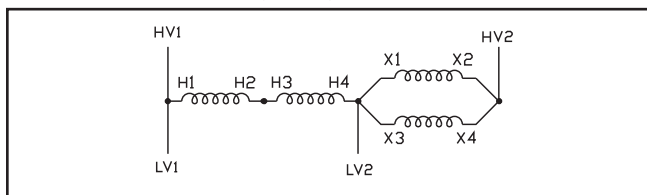
Buck-Boost Wiring Diagram 1



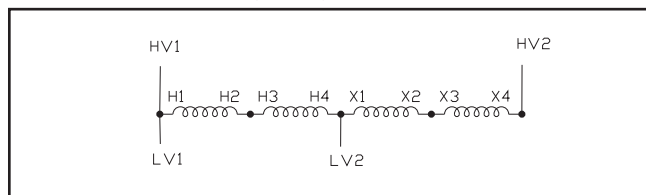
Buck-Boost Wiring Diagram 2



Buck-Boost Wiring Diagram 3



Buck-Boost Wiring Diagram 4



Version JE901 0809 Date Sept 08



1-800-892-3755

www.jeffersonelectric.com

Dry-Type Transformers

9.5

9

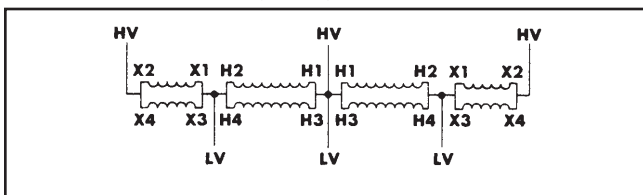
Buck-Boost – Powerformer™

Three-Phase KVA Capacity of Encapsulated Powerformers™ Connected in Open-Delta Maximum load capabilities requiring two Powerformers

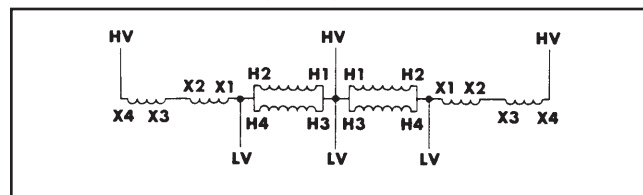
Low Voltage (LV)	High Voltage (HV)	Catalog Number	Load Required*	01 .100 KVA	11 .150 KVA	21 .250 KVA	31 .500 KVA	41 .750 KVA	51 1.0 KVA	61 1.5 KVA	71 2.0 KVA	81 3.0 KVA	91 5.0 KVA	Wiring Diagram
200	240	416-14xx	KVA	0.86	1.29	2.1	4.3	6.4	8.6	12.9	17.2	25.0	43.0	10
			Amperes	2.1	3.1	5.1	10.3	15.4	20.7	31.0	41.4	60.1	103.4	
208	236	416-12xx	KVA	1.27	1.91	3.1	6.3	9.5	12.7	19.1	25.5	38.2	63.7	12
			Amperes	3.1	4.7	7.6	15.4	23.2	31.1	46.7	62.4	93.4	155.8	
212	240	416-12xx	KVA	1.29	1.94	3.2	6.4	9.7	12.9	19.4	25.8	38.0	64.0	12
			Amperes	3.1	4.7	7.7	15.4	23.3	31.0	46.7	62.1	91.4	154.0	
208	230	416-11xx	KVA	1.65	2.47	4.1	8.2	12.3	16.5	24.7	33.0	49.5	82.5	12
			Amperes	4.1	6.2	10.3	20.6	30.9	41.4	62.0	82.8	124.3	207.1	
218	240	416-11xx	KVA	1.73	2.59	4.3	8.6	12.9	17.3	25.9	34.6	51.0	86.0	12
			Amperes	4.2	6.2	10.3	20.7	31.0	41.6	62.3	83.2	122.7	206.9	
225	240	416-12xx	KVA	2.59	3.89	6.4	12.9	19.4	25.9	38.9	51.9	77.0	129	11
			Amperes	6.2	9.4	15.4	31.0	46.7	62.3	93.6	124.8	185.2	310.3	
229	240	416-11xx	KVA	3.46	5.18	8.6	17.3	25.9	34.6	51.8	69.2	103	173	11
			Amperes	8.3	12.5	20.7	41.6	62.3	83.2	124.6	166.5	247.8	416.2	
230	253	416-14xx	KVA	1.81	2.72	4.5	9.0	13.6	18.1	27.2	36.3	54.0	90.0	9
			Amperes	4.1	6.2	10.3	20.5	31.0	41.3	62.1	82.8	123.2	205.4	
230	276	416-14xx	KVA	0.99	1.49	2.4	4.9	7.4	9.9	14.9	19.9	29.0	49.0	10
			Amperes	2.1	3.1	5.0	10.2	15.5	20.7	31.2	41.6	60.7	102.5	
240	252	416-11xx	KVA	3.64	5.47	9.1	18.2	27.2	36.4	54.7	72.8	109	182	11
			Amperes	8.3	12.5	20.8	41.7	62.3	83.4	125.3	166.8	249.7	417.0	
240	264	416-11xx	KVA	1.9	2.86	4.7	9.5	14.2	19.0	28.6	38.1	57.0	95.0	12
			Amperes	4.2	6.3	10.3	20.8	31.1	41.6	62.5	83.3	124.7	207.8	
240	272	416-12xx	KVA	1.47	2.2	3.6	7.3	11.0	14.7	22.0	29.4	44.1	73.6	12
			Amperes	3.1	4.7	7.6	15.5	23.3	31.2	46.7	62.4	93.6	156.2	
240	288	416-14xx	KVA	1.03	1.55	2.5	5.1	7.7	10.3	15.5	20.7	31.0	51.0	10
			Amperes	2.1	3.1	5.0	10.2	15.4	20.6	31.1	41.5	62.1	102.2	
437	480	416-14xx	KVA	1.73	2.59	4.3	8.6	12.9	17.3	25.9	34.6	51.0	86.0	12
			Amperes	2.1	3.1	5.2	10.3	15.5	20.8	31.2	41.6	61.3	103.4	
457	480	416-14xx	KVA	3.46	5.18	8.6	17.3	25.9	34.6	51.8	69.2	103	173	11
			Amperes	4.2	6.2	10.3	20.8	31.2	41.6	62.3	83.2	123.9	208.1	
480	504	416-14xx	KVA	3.64	5.47	9.1	18.2	27.2	36.4	54.7	72.8	109	183	11
			Amperes	4.2	6.3	10.4	20.8	31.2	41.7	62.7	83.4	124.9	209.6	
480	528	416-14xx	KVA	1.9	2.86	4.7	9.5	14.2	19.0	28.6	38.1	57.0	95.0	12
			Amperes	2.1	3.1	5.1	10.4	15.5	20.8	31.3	41.7	62.3	103.9	

* Load required is calculated based on the low voltage as the load.

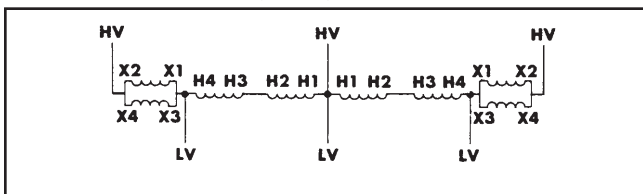
Buck-Boost Wiring Diagram 9



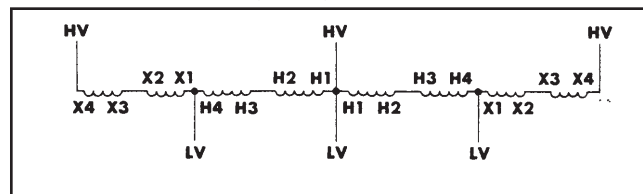
Buck-Boost Wiring Diagram 10



Buck-Boost Wiring Diagram 11

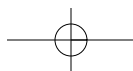


Buck-Boost Wiring Diagram 12



Version JE901 0809 Date Sept 08





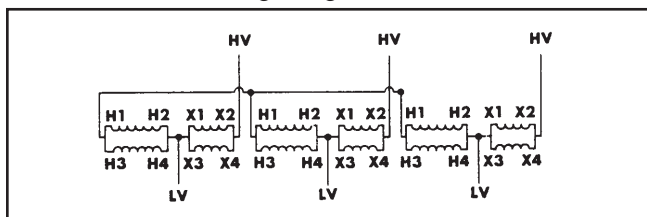
Buck-Boost – Powerformer™

Three-Phase KVA Capacity of Encapsulated Powerformers™ Connected in Wye Maximum load capabilities requiring three Powerformers

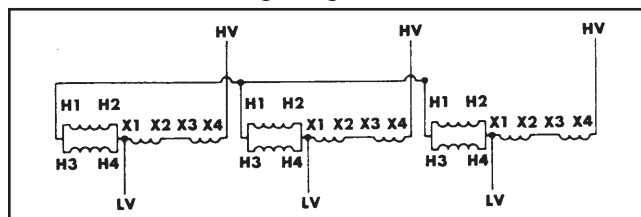
Low Voltage (LV)	High Voltage (HV)	Catalog Number	Load Required*	.01 KVA	.11 KVA	.21 KVA	.31 KVA	.41 KVA	.51 KVA	.61 KVA	.71 KVA	.81 KVA	.91 KVA	Wiring Diagram
164	208	416-12	KVA	1.1	1.7	2.8	5.6	8.4	11.2	16.8	22.0	34.0	56.0	6
			AMPS	3.89	5.89	9.79	18.9	29.4	38.9	58.9	78.9	117	197	
173	208	416-11	KVA	1.5	2.2	3.7	7.5	11.2	15.0	22.5	30.0	45.0	75.0	6
			AMPS	5.0	7.5	12.5	25.0	37.0	50.0	75.0	100	150	250	
183	208	416-12	KVA	2.2	3.3	5.6	11.2	16.8	22.5	33.7	45.0	67.0	112	5
			AMPS	7.07	10.5	17.6	34.9	52.8	70.7	105	141	212	354	
189	208	416-11	KVA	3.0	4.5	7.5	15.0	22.5	30.0	45.0	60.0	90.0	150	5
			AMPS	9.17	13.7	22.9	45.8	68.8	91.7	137	183	275	458	
208	229	416-11	KVA	3.3	4.9	8.2	16.5	24.7	33.0	49.5	66.0	99.0	165	5
			AMPS	9.17	13.7	22.9	45.8	68.8	91.7	137	183	275	458	
208	235	416-12	KVA	2.5	3.8	6.3	12.7	19.1	25.5	38.2	51.0	76.5	127	5
			AMPS	7.08	10.5	17.6	35.0	52.5	70.8	105	141	212	350	
208	249	416-11	KVA	1.8	2.7	4.5	9.0	13.5	18.0	27.0	36.0	54.0	90.0	6
			AMPS	5.0	7.5	12.5	25.0	37.5	50.0	75.0	100	150	250	
208	263	416-12	KVA	1.4	2.1	3.5	7.1	10.6	14.2	21.4	28.0	42.0	71.0	6
			AMPS	3.91	5.91	9.83	19.1	29.1	39.1	59.1	79.1	118	191	
346	416	416-14	KVA	1.5	2.2	3.7	7.5	11.2	15.0	22.5	30.0	45.0	75.0	6
			AMPS	2.5	3.75	6.25	12.5	18.5	25.0	37.5	50.0	75.0	125	
367	416	416-12	KVA	2.2	3.3	5.6	11.2	16.8	22.5	33.7	45.0	67.0	112	8
			AMPS	3.53	5.28	8.82	17.4	26.4	35.3	52.8	70.7	106	174	
378	416	416-11	KVA	3.0	4.5	7.5	15.0	22.5	30.0	45.0	60.0	90.0	150	8
			AMPS	4.58	6.88	11.4	22.9	34.4	45.8	68.8	91.7	137	229	
390	416	416-12	KVA	4.5	6.7	11.2	22.5	33.7	45.0	67.5	90.0	135	225	7
			AMPS	6.66	10.0	16.6	33.3	49.7	66.6	100	133	200	333	
397	416	416-11	KVA	6.0	9.0	15.0	30.0	45.0	60.0	90.0	120	180	300	7
			AMPS	8.73	13.1	21.8	43.6	65.5	87.3	131	174	262	436	
398	438	416-14	KVA	3.1	4.7	7.8	15.7	23.6	31.5	47.2	63.0	94.0	157	5
			AMPS	4.56	6.82	11.3	22.6	33.9	45.6	68.2	91.3	136	229	
398	478	416-14	KVA	1.7	2.5	4.3	8.6	12.9	17.2	25.9	34.0	51.0	86.0	6
			AMPS	2.50	3.75	6.25	12.5	18.7	25.0	37.5	50.0	75.0	125	
416	437	416-11	SKVA	6.3	9.4	15.7	31.5	47.2	63.0	94.5	126	189	315	7
			AMPS	8.75	13.1	21.8	43.7	65.4	87.5	131	175	262	437	
416	443	416-12	KVA	4.8	7.2	12.0	24.0	36.0	48.0	72.0	96.0	144	240	7
			AMPS	6.66	10.0	16.6	33.3	50.0	66.6	100	133	200	333	
416	457	416-11	KVA	3.3	4.9	8.2	16.5	24.7	33.0	49.5	66.0	99.0	165	8
			AMPS	4.58	6.87	11.4	22.9	34.1	45.8	68.7	91.6	137	229	
416	471	416-12	KVA	2.5	3.8	6.3	12.7	19.1	25.5	38.2	51.0	76.5	127	8
			AMPS	3.54	5.29	8.83	17.5	26.2	35.4	52.9	70.8	106	175	
416	498	416-14	KVA	1.8	2.7	4.5	9.0	13.5	18.0	27.0	36.0	54.0	90.0	6
			AMPS	2.5	3.75	6.25	12.5	18.7	25.0	37.5	50.0	75.0	125	

* Load required is calculated based on the low voltage as the load.

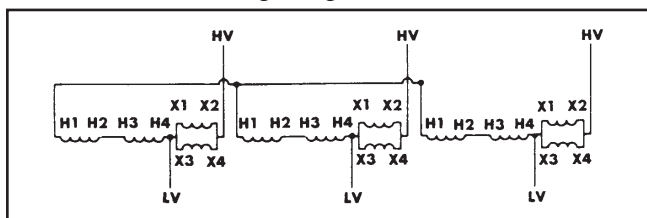
Buck-Boost Wiring Diagram 5



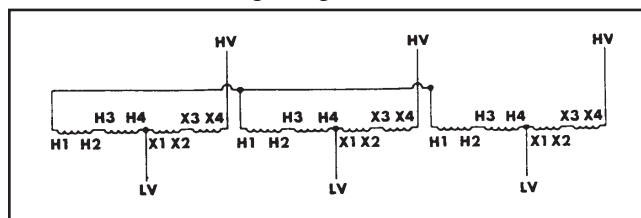
Buck-Boost Wiring Diagram 6



Buck-Boost Wiring Diagram 7



Buck-Boost Wiring Diagram 8

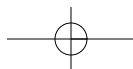


Version JE901 0809 Date Sept 08



1-800-892-3755 www.jeffersonelectric.com

Dry-Type Transformers



9

Buck-Boost – Powerformer™

Single-Phase - 600V Class

.050 – 1 KVA: 130°C Insulation Class • 1.5 – 10 KVA: 180°C Insulation Class

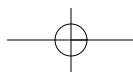
KVA	Catalog Number	Fig.	Height A (in.)	Width B (in.)	Depth C (in.)	Wiring Diagram	Est. Ship Wgt. (lbs.)
120 x 240 V – 12/24 V 60 Hz							
.050	416-1100-000	2	8.03	3.31	3.08	S240B	4.4
.100	416-1101-000	2	8.03	3.31	3.08		4.8
.150	416-1111-000	2	8.03	3.31	3.08		5.6
.250	416-1121-000	2	8.03	3.31	3.08		6.7
.500	416-1131-000	2	10.19	5.06	4.59		15.0
.750	416-1141-000	2	10.19	5.06	4.59		17.0
1	416-1151-000	2	10.19	5.06	4.59		19.5
1.5	416-1161-000	3	12.50	6.69	5.34		35.0
2	416-1171-000	3	12.50	6.69	5.34		41.2
3	416-1181-000	3	14.56	7.56	7.15		48.0
5	416-1191-000	3	14.56	7.56	7.15	90.5	
7.5	416-2101-000	4	16.12	13.50	8.55	130.0	
10	416-2111-000	4	16.12	13.50	8.55	158.0	
120 x 240 V – 16/32 V 60 Hz							
.100	416-1201-000	2	8.03	3.31	3.08	S240C	4.8
.150	416-1211-000	2	8.03	3.31	3.08		5.6
.250	416-1221-000	2	8.03	3.31	3.08		6.7
.500	416-1231-000	2	10.19	5.06	4.59		15.0
.750	416-1241-000	2	10.19	5.06	4.59		17.0
1	416-1251-000	2	10.19	5.06	4.59		19.5
1.5	416-1261-000	3	12.50	6.69	5.34		35.0
2	416-1271-000	3	12.50	6.69	5.34		41.2
3	416-1281-000	3	14.56	7.56	7.15		48.0
5	416-1291-000	3	14.56	7.56	7.15		90.5
7.5	416-2201-000	4	16.12	13.50	8.55	130.0	
10	416-2211-000	4	16.12	13.50	8.55	158.0	
240 x 480 V – 24/48 Vs 60 Hz							
.100	416-1401-000	2	8.03	3.31	3.08	S480E	4.8
.150	416-1411-000	2	8.03	3.31	3.08		5.6
.250	416-1421-000	2	8.03	3.31	3.08		6.7
.500	416-1431-000	2	10.19	5.06	4.59		15.0
.750	416-1441-000	2	10.19	5.06	4.59		17.0
1	416-1451-000	2	10.19	5.06	4.59		19.5
1.5	416-1461-000	3	12.50	6.69	5.34		35.0
2	416-1471-000	3	12.50	6.69	5.34		41.2
3	416-1481-000	3	14.56	7.56	7.15		48.0
5	416-1491-000	3	14.56	7.56	7.15		90.5
7.5	416-2401-000	4	16.12	13.50	8.55	130.0	
10	416-2411-000	4	16.12	13.50	8.55	158.0	

Note: Housing dimensions subject to change without notice. Contact factory where dimension verification is critical.



Version JE901 0809 Date Feb 09





Buck-Boost – Powerformer™

Figure 2

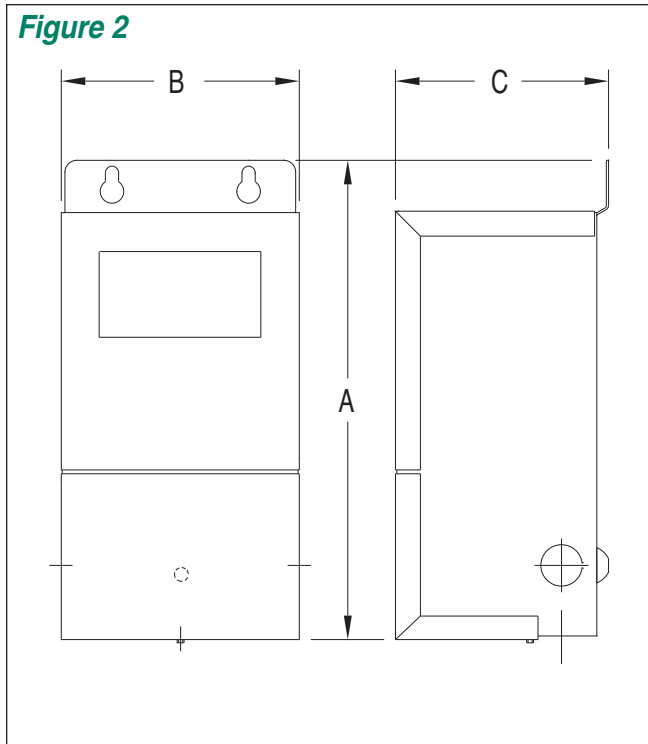


Figure 3

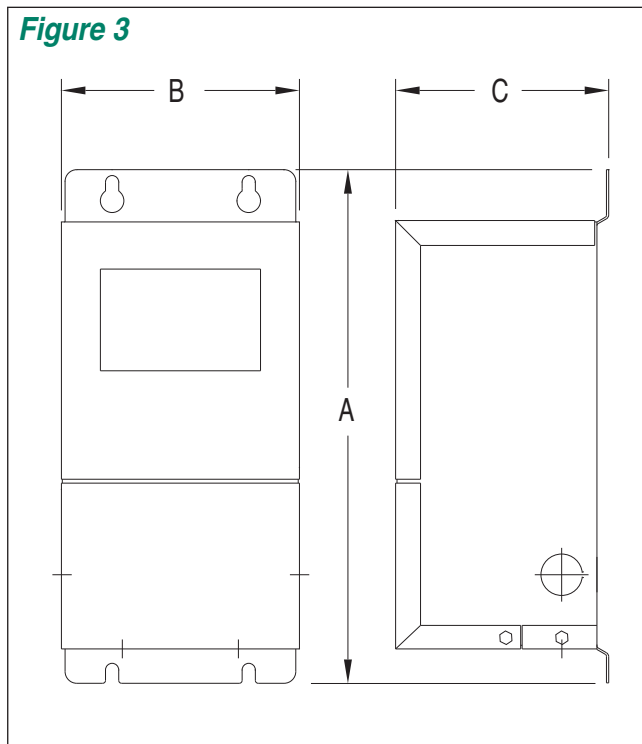
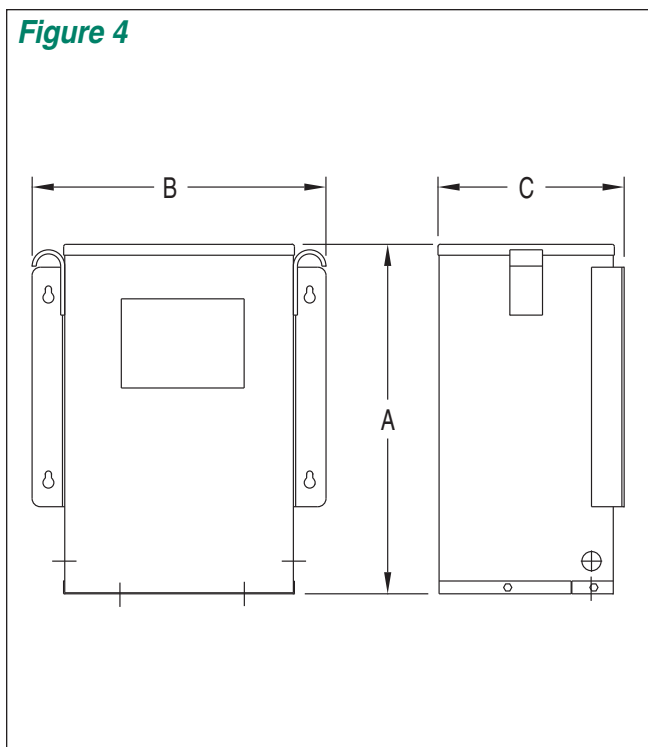


Figure 4



Version JE901 0809 Date Sept 08

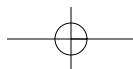


1-800-892-3755

www.jeffersonelectric.com

Dry-Type Transformers

9.9



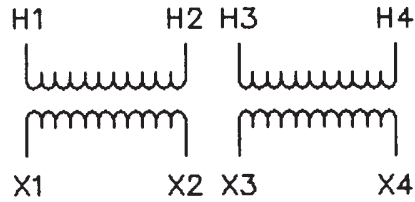
9

Buck-Boost – Powerformer™

S240B Wiring Diagram & Connections*

Wiring Diagram

Primary: 120 X 240
Secondary: 12/24



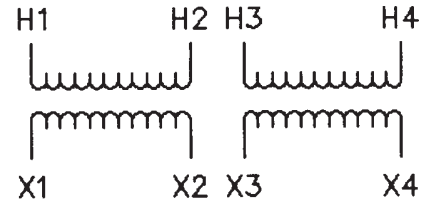
Connections

Primary Volts	Interconnect	Primary Lines Connect To
240	H2 to H3	H1-H4
120	H1 to H3 H2 to H4	H1-H4
Sec. Volts	Interconnect	Secondary Lines Connect To
24	X2 to X3	X1-X4
12	X1 to X3 X2 to X4	X1-X4

S240C Wiring Diagram & Connections*

Wiring Diagram

Primary: 120 X 240
Secondary: 16/32



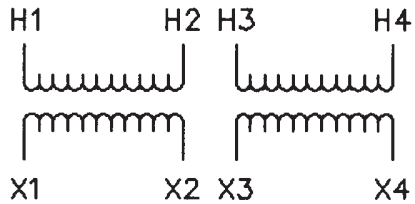
Connections

Primary Volts	Interconnect	Primary Lines Connect To
240	H2 to H3	H1-H4
120	H1 to H3 H2 to H4	H1-H4
Sec. Volts	Interconnect	Secondary Lines Connect To
32	X2 to X3	X1-X4
16	X1 to X3 X2 to X4	X1-X4

S480E Wiring Diagram & Connections*

Wiring Diagram

Primary: 240 X 480
Secondary: 24/48



Connections

Primary Volts	Interconnect	Primary Lines Connect To
480	H2 to H3	H1-H4
240	H1 to H3 H2 to H4	H1-H4
Sec. Volts	Interconnect	Secondary Lines Connect To
48	X2 to X3	X1-X4
24	X1 to X3 X2 to X4	X1-X4

NOTE: Electrostatic shields are optionally available and not shown in all wiring diagrams.

Industrial Control

10



50 to 5000 VA

Contents

Overview	10.2
Dimensional Drawings	10.11
Wiring Diagrams	10.7
Fuse kits and Terminal covers	10.7

Selection Charts

Group	Primary Voltages	Secondary Voltages	
AA	220/230/240 x 440/460/480	110/115/120	10.3
BB	240 x 480	24	10.3
CC	120 x 240	24	10.3
EE	550/575/600	110/115/120	10.4
FF	208 x 277	120	10.4
GG	208 x 230 x 460	115	10.4
HH	230 x 460 x 575	95 x 115	10.5
II	380 x 400 x 415	110 x 220	10.5
JJ	200/208 x 220/230/240 x 440/460/480	23/24/25, 110/115/120	10.5
KK	240 x 480	120 x 240	10.6
LL	208/220/230/240 x 380/400/416 x 440/460/480 x 500/550/575/600	110/120/125/130, 100/110/115/120, 85/91/95/99	10.6
MM	220/230/240 x 440/460/480	110/115/120 x 220/230/240	10.6
NN	240 x 347 x 380	120 x 240	10.7

Version JE901 0809 Date Sept 08



1-800-892-3755

www.jeffersonelectric.com

Dry-Type Transformers

10.1

10 Industrial Control

Products

- *General purpose; 50 VA to 5000 VA*

Applications

- *For commercial and industrial control applications including; control panels, conveyor systems, machine tool equipment, pump systems, and commercial air conditioning applications*

Specifications

- *Encapsulated*
- *Cores of high-grade silicon steel*
- *50/60 Hz operation*
- *Machine wound copper coils*
- *Phil-Slot-Hex head terminal screws*
- *For 50 VA to 100 VA – Insulation Class of 105°C and Temp Rise of 55°C*
- *For 150 VA to 1000 VA – Insulation Class of 130°C and Temp Rise of 80°C*
- *For 1500 VA to 5000 VA – Insulation Class of 180°C and Temp Rise of 115°C*

Features and Benefits

- *Slotted mounting holes for quick and easy mounting*
- *Permanently affixed wiring diagram for quick reference*
- *Secondary fuse clips standard on units with a single secondary voltage (-000 units)*
- *Terminal jumpers for quick series/parallel connections*

Standards

- *Built in accordance with ANSI, UL, and cUL standards*
- *UL and cUL Listed*
- *Models with CE Marking are available*

Options and Accessories

- *Other sizes and voltages are available*
- *Optional primary fuse clips available*
- *Finger safe terminal covers available*
- *Finger safe fuse covers available*
- *The optional primary fuse block is for a 13/32 x 1-1/2 class cc rejection fuse. The primary fuse should always be time delay, slow blow properly sized for the application.*
- *The standard secondary fuse clip is for a 13/32 x 1-1/2 midget fuse. The secondary fuse style is a matter of customer preference usually either time delay or fast acting.*

Version JE901 0809 Date Feb 09

Industrial Control

Group AA

VA	Catalog Number	Fig	Dimensions*					Est. Ship Weight	Temp Rise	Insulation Temp.	Secondary Fuse Clip	Terminal Cover	Fuse Block
			A	B	C	D	E						
220/230/240 x 440/460/480 - 110/115/120													
50	631-1101-000	14	3.78	3.00	2.73	1.96	2.5	2.8	55	105	Included	631-0000-004	631-0000-001
75	631-1201-000	14	4.03	3.00	2.73	2.42	2.5	3.5	55	105	Included	631-0000-004	631-0000-001
100	631-1301-000	14	4.03	3.38	3.04	2.42	2.81	4.3	55	105	Included	631-0000-004	631-0000-001
150	631-1401-000	14	4.03	3.75	3.35	2.82	3.13	5.6	80	130	Included	631-0000-004	631-0000-001
200	631-1501-000	14	4.37	4.50	3.98	2.62	3.75	7.7	80	130	Included	631-0000-004	631-0000-001
250	631-1601-000	14	4.37	4.50	3.98	2.82	3.75	8.3	80	130	Included	631-0000-004	631-0000-001
300	631-1701-000	14	4.74	4.50	3.98	3.19	3.75	9.7	80	130	Included	631-0000-004	631-0000-001
350	631-1801-000	14	4.74	4.50	3.98	3.74	3.75	10.4	80	130	Included	631-0000-004	631-0000-001
500	631-1901-000	14	6.11	5.25	4.64	3.87	4.38	14.5	80	130	Included	631-0000-006	631-0000-001
750	631-2001-000	14	7.61	5.25	4.64	5.37	4.38	27.6	80	130	Included	631-0000-006	631-0000-001
1000	631-2101-000	14	7.11	6.75	5.88	4.97	6.13	32.3	80	130	Included	631-0000-006	631-0000-001
1500	631-2201-000	14	8.11	6.75	5.88	6.12	6.13	50.1	115	180	Included	631-0000-006	631-0000-001
2000	631-2301-000	15	7.75	6.75	5.75	5	6.13	46.0	115	180	Included	631-0000-006	631-0000-001
3000	631-2401-001	15	8.00	9.00	7.5	5.25	7.5	69.8	115	180	NA	631-0000-006	NA
5000	631-2601-001	15	10.0	9.00	7.5	7.19	7.5	109.9	115	180		631-0000-006	

Group BB

VA	Catalog Number	Fig	Dimensions*					Est. Ship Weight	Temp Rise	Insulation Temp.	Secondary Fuse Clip	Terminal Cover	Fuse Block
			A	B	C	D	E						
240 x 480 - 24													
50	631-1102-000	14	3.78	3.00	2.73	1.96	2.50	2.8	55	105	Included	631-0000-004	631-0000-001
75	631-1202-000	14	4.03	3.00	2.73	2.42	2.50	3.5	55	105	Included	631-0000-004	631-0000-001
100	631-1302-000	14	4.03	3.38	3.04	2.42	2.81	4.3	55	105	Included	631-0000-004	631-0000-001
150	631-1402-000	14	4.03	3.75	3.35	2.82	3.13	5.6	80	130	Included	631-0000-004	631-0000-001
200	631-1502-000	14	4.37	4.50	3.98	2.62	3.75	7.7	80	130	Included	631-0000-004	631-0000-001
250	631-1602-000	14	4.37	4.50	3.98	2.82	3.75	8.3	80	130	Included	631-0000-004	631-0000-001
300	631-1702-000	14	4.74	4.50	3.98	3.19	3.75	9.7	80	130	Included	631-0000-004	631-0000-001
350	631-1802-000	14	4.74	4.50	3.98	3.74	3.75	10.4	80	130	Included	631-0000-004	631-0000-001
500	631-1902-000	14	6.11	5.25	4.64	3.87	4.38	14.5	80	130	Included	631-0000-006	631-0000-001
750	631-2002-001	14	7.61	5.25	4.64	5.37	4.38	27.6	80	130	NA	631-0000-006	631-0000-001

Group CC

VA	Catalog Number	Fig	Dimensions*					Est. Ship Weight	Temp Rise	Insulation Temp.	Secondary Fuse Clip	Terminal Cover	Fuse Block
			A	B	C	D	E						
120 x 240 - 24													
50	631-1103-000	14	3.78	3.00	2.73	1.96	2.50	2.8	55	105	Included	631-0000-004	631-0000-001
75	631-1203-000	14	4.03	3.00	2.73	2.42	2.50	3.5	55	105	Included	631-0000-004	631-0000-001
100	631-1303-000	14	4.03	3.38	3.04	2.42	2.81	4.3	55	105	Included	631-0000-004	631-0000-001
150	631-1403-000	14	4.03	3.75	3.35	2.82	3.13	5.6	80	130	Included	631-0000-004	631-0000-001
200	631-1503-000	14	4.37	4.50	3.98	2.62	3.75	7.7	80	130	Included	631-0000-004	631-0000-001
250	631-1603-000	14	4.37	4.50	3.98	2.82	3.75	8.3	80	130	Included	631-0000-004	631-0000-001
300	631-1703-000	14	4.74	4.50	3.98	3.19	3.75	9.7	80	130	Included	631-0000-004	631-0000-001
350	631-1803-000	14	4.74	4.50	3.98	3.74	3.75	10.4	80	130	Included	631-0000-004	631-0000-001
500	631-1903-000	14	6.11	5.25	4.64	3.87	4.38	14.5	80	130	Included	631-0000-006	631-0000-001
750	631-2003-001	14	7.61	5.25	4.64	5.37	4.38	27.6	80	130	NA	631-0000-006	631-0000-001

Note: Housing dimensions subject to change without notice. Consult website or factory where dimensions are critical.
 * Secondary fuse clips add 0.5" to C dimension.



Version JE901 0809 Date Sept.08



1-800-892-3755 www.jeffersonelectric.com

Dry-Type Transformers

10.3

10 Industrial Control

Group EE

VA	Catalog Number	Fig	Dimensions*					Est. Ship Weight	Temp Rise	Insulation Temp.	Secondary Fuse Clip	Terminal Cover	Fuse Block
			A	B	C	D	E						
550/575/600 - 110/115/120													
50	631-1104-000	14	3.78	3.00	2.73	1.96	2.50	2.8	55	105	Included	631-0000-004	631-0000-001
75	631-1204-000	14	4.03	3.00	2.73	2.42	2.50	3.5	55	105	Included	631-0000-004	631-0000-001
100	631-1304-000	14	4.03	3.38	3.04	2.42	2.81	4.3	55	105	Included	631-0000-004	631-0000-001
150	631-1404-000	14	4.03	3.75	3.35	2.82	3.13	5.6	80	130	Included	631-0000-004	631-0000-001
200	631-1504-000	14	4.37	4.50	3.98	2.62	3.75	7.7	80	130	Included	631-0000-004	631-0000-001
250	631-1604-000	14	4.37	4.50	3.98	2.82	3.75	8.3	80	130	Included	631-0000-004	631-0000-001
300	631-1704-000	14	4.74	4.50	3.98	3.19	3.75	9.7	80	130	Included	631-0000-004	631-0000-001
350	631-1804-000	14	4.74	4.50	3.98	3.74	3.75	10.4	80	130	Included	631-0000-004	631-0000-001
500	631-1904-000	14	6.11	5.25	4.64	3.87	4.38	14.5	80	130	Included	631-0000-006	631-0000-001
750	631-2004-000	14	7.61	5.25	4.64	5.37	4.38	27.6	80	130	Included	631-0000-006	631-0000-001

Group FF

VA	Catalog Number	Fig	Dimensions*					Est. Ship Weight	Temp Rise	Insulation Temp.	Secondary Fuse Clip	Terminal Cover	Fuse Block
			A	B	C	D	E						
208 x 277 - 120													
50	631-1105-000	14	3.78	3.00	2.73	1.96	2.50	2.8	55	105	Included	631-0000-004	631-0000-001
75	631-1205-000	14	4.03	3.00	2.73	2.42	2.50	3.5	55	105	Included	631-0000-004	631-0000-001
100	631-1305-000	14	4.03	3.38	3.04	2.42	2.81	4.3	55	105	Included	631-0000-004	631-0000-001
150	631-1405-000	14	4.03	3.75	3.35	2.82	3.13	5.6	80	130	Included	631-0000-004	631-0000-001
200	631-1505-000	14	4.37	4.50	3.98	2.62	3.75	7.7	80	130	Included	631-0000-004	631-0000-001
250	631-1605-000	14	4.37	4.50	3.98	2.82	3.75	8.3	80	130	Included	631-0000-004	631-0000-001
300	631-1705-000	14	4.74	4.50	3.98	3.19	3.75	9.7	80	130	Included	631-0000-004	631-0000-001
350	631-1805-000	14	4.74	4.50	3.98	3.74	3.75	10.4	80	130	Included	631-0000-004	631-0000-001
500	631-1905-000	14	6.11	5.25	4.64	3.87	4.38	14.5	80	130	Included	631-0000-006	631-0000-001
750	631-2005-000	14	7.61	5.25	4.64	5.37	4.38	27.6	80	130	Included	631-0000-006	631-0000-001

Group GG

VA	Catalog Number	Fig	Dimensions*					Est. Ship Weight	Temp Rise	Insulation Temp.	Secondary Fuse Clip	Terminal Cover	Fuse Block
			A	B	C	D	E						
208 x 230 x 460 - 115													
50	631-1106-000	14	3.77	3.00	2.73	2.21	2.50	2.8	55	105	Included	631-0000-004	631-0000-001
75	631-1206-000	14	4.02	3.38	3.04	2.42	2.81	3.5	55	105	Included	631-0000-004	631-0000-001
100	631-1306-000	14	4.02	3.38	3.04	2.62	2.81	4.3	55	105	Included	631-0000-004	631-0000-001
150	631-1406-000	14	4.02	3.75	3.35	2.81	3.13	5.6	80	130	Included	631-0000-004	631-0000-001
200	631-1506-000	14	4.36	4.50	3.98	2.81	3.75	7.7	80	130	Included	631-0000-004	631-0000-001
250	631-1606-000	14	4.36	4.50	3.98	3.19	3.75	8.3	80	130	Included	631-0000-004	631-0000-001
300	631-1706-000	14	4.74	4.50	3.98	3.19	3.75	9.7	80	130	Included	631-0000-004	631-0000-001
350	631-1806-000	14	5.75	4.50	3.98	4.72	3.75	10.4	80	130	Included	631-0000-004	631-0000-001
500	631-1906-000	14	6.11	5.25	4.64	4.38	4.38	14.5	80	130	Included	631-0000-006	631-0000-001
750	631-2006-000	14	7.61	5.25	4.64	5.87	4.38	27.6	80	130	Included	631-0000-006	631-0000-001
1000	631-2106-000	14	7.11	6.75	5.88	4.97	6.13	32.3	80	130	Included	631-0000-006	631-0000-001
1500	631-2206-000	15	7.38	6.75	5.75	4.25	6.13	40.7	115	180	Included	631-0000-006	631-0000-001
2000	631-2306-000	15	8.13	6.75	5.75	5.25	6.13	51.7	115	180	Included	631-0000-006	631-0000-001
3000	631-2406-001	15	8.56	9.00	7.50	5.75	7.50	77.1	115	180	NA	631-0000-006	NA
5000	631-2606-001	15	10.38	9.00	7.50	7.56	7.50	117.2	115	180	NA	631-0000-006	NA

Note: Housing dimensions subject to change without notice. Consult website or factory where dimensions are critical.

* Secondary fuse clips add 0.5" to C dimension.



10.4

Dry-Type Transformers

www.jeffersonelectric.com 1-800-892-3755



Version JE901 0809 Date Sept 08

Industrial Control

Group HH

VA	Catalog Number	Fig	Dimensions*					Est. Ship Weight	Temp Rise	Insulation Temp.	Secondary Fuse Clip	Terminal Cover	Fuse Block
			A	B	C	D	E						
230 x 460 x 575 - 95, 115													
1000	631-2107-000	15	7.00	6.38	5.44	5.06	5.31	31.8	115	180	Included	631-0000-006	631-0000-001
1500	631-2207-000	15	7.75	6.75	5.75	5.25	6.13	44.3	115	180	Included	631-0000-006	631-0000-001
2000	631-2307-000	15	7.63	9.00	7.50	4.81	7.50	57.4	115	180	Included	631-0000-006	631-0000-001
3000	631-2407-001	15	8.75	9.00	7.50	5.94	7.50	83.6	115	180	NA	631-0000-006	NA
5000	631-2607-001	15	11.0	9.00	7.50	8.19	7.50	129.5	115	180		631-0000-006	

Group II

VA	Catalog Number	Fig	Dimensions*					Est. Ship Weight	Temp Rise	Insulation Temp.	Secondary Fuse Clip	Terminal Cover	Fuse Block
			A	B	C	D	E						
380 x 400 x 415 - 110 x 220													
50	631-1108-001	14	3.78	3.00	2.73	1.96	2.50	2.8	55	105	NA	631-0000-004	631-0000-001
75	631-1208-001	14	4.03	3.00	2.73	2.42	2.50	3.5	55	105		631-0000-004	631-0000-001
100	631-1308-001	14	4.03	3.38	3.04	2.42	2.81	4.3	55	105		631-0000-004	631-0000-001
150	631-1408-001	14	4.03	3.75	3.35	2.82	3.13	5.6	80	130		631-0000-004	631-0000-001
200	631-1508-001	14	4.37	4.50	3.98	2.62	3.75	7.7	80	130		631-0000-004	631-0000-001
250	631-1608-001	14	4.37	4.50	3.98	2.82	3.75	8.3	80	130		631-0000-004	631-0000-001
300	631-1708-001	14	4.74	4.50	3.98	3.19	3.75	9.7	80	130		631-0000-004	631-0000-001
350	631-1808-001	14	4.74	4.50	3.98	3.74	3.75	10.4	80	130		631-0000-004	631-0000-001
500	631-1908-001	14	6.11	5.25	4.64	3.87	4.38	14.5	80	130		631-0000-006	631-0000-001
750	631-2008-001	14	7.61	5.25	4.64	5.37	4.38	27.6	80	130		631-0000-006	631-0000-001

Group JJ

VA	Catalog Number	Fig	Dimensions*					Est. Ship Weight	Temp Rise	Insulation Temp.	Secondary Fuse Clip	Terminal Cover	Fuse Block
			A	B	C	D	E						
200/208 x 220/230/240 x 440/460/480 - 23/24/25, 110/115/120													
50	631-1109-000	14	4.52	3.00	2.73	2.81	2.50	2.8	55	105	Included	631-0000-004	631-0000-001
75	631-1209-000	14	4.52	3.38	3.04	2.81	2.81	3.5	55	105	Included	631-0000-004	631-0000-001
100	631-1309-000	14	4.52	3.75	3.35	2.99	3.13	4.3	55	105	Included	631-0000-004	631-0000-001
150	631-1409-000	14	5.02	3.75	3.35	3.19	3.13	5.6	80	130	Included	631-0000-004	631-0000-001
200	631-1509-000	14	4.36	4.50	3.98	3.00	3.75	7.7	80	130	Included	631-0000-004	631-0000-001
250	631-1609-000	14	4.74	4.50	3.98	3.75	3.75	8.3	80	130	Included	631-0000-004	631-0000-001
300	631-1709-000	14	6.11	5.25	4.64	3.88	4.38	9.7	80	130	Included	631-0000-006	631-0000-001
350	631-1809-000	14	6.11	5.25	4.64	3.88	4.38	10.4	80	130	Included	631-0000-006	631-0000-001
500	631-1909-000	14	7.11	5.25	4.64	4.38	5.38	14.5	80	130	Included	631-0000-006	631-0000-001

Note: Housing dimensions subject to change without notice. Consult website or factory where dimensions are critical.
 * Secondary fuse clips add 0.5" to C dimension.



Version JE901 0809 Date Sept 08



1-800-892-3755 www.jeffersonelectric.com

Dry-Type Transformers

10.5

10 Industrial Control

Group KK

VA	Catalog Number	Fig	Dimensions*					Est. Ship Weight	Temp Rise	Insulation Temp.	Secondary Fuse Clip	Terminal Cover	Fuse Block
			A	B	C	D	E						
240 x 480 - 120 x 240													
50	631-1110-001	14	3.78	3.00	2.73	1.96	2.50	2.8	55	105	NA	631-0000-004	631-0000-001
75	631-1210-001	14	4.03	3.00	2.73	2.42	2.50	3.5	55	105		631-0000-004	631-0000-001
100	631-1310-001	14	4.03	3.38	3.04	2.42	2.81	4.3	55	105		631-0000-004	631-0000-001
150	631-1410-001	14	4.03	3.75	3.35	2.82	3.13	5.6	80	130		631-0000-004	631-0000-001
200	631-1510-001	14	4.37	4.50	3.98	2.62	3.75	7.7	80	130		631-0000-004	631-0000-001
250	631-1610-001	14	4.37	4.50	3.98	2.82	3.75	8.3	80	130		631-0000-004	631-0000-001
300	631-1710-001	14	4.74	4.50	3.98	3.19	3.75	9.7	80	130		631-0000-004	631-0000-001
350	631-1810-001	14	4.74	4.50	3.98	3.74	3.75	10.4	80	130		631-0000-004	631-0000-001
500	631-1910-001	14	6.11	5.25	4.64	3.87	4.38	14.5	80	130		631-0000-006	631-0000-001
750	631-2010-001	14	7.61	5.25	4.64	5.37	4.38	27.6	80	130		631-0000-006	631-0000-001

Group LL

VA	Catalog Number	Fig	Dimensions*					Est. Ship Weight	Temp Rise	Insulation Temp.	Secondary Fuse Clip	Terminal Cover	Fuse Block
			A	B	C	D	E						
200 to 600 - 85 to 130													
50	631-1111-000	15	3.43	3.88	2.93	2.41	2.81	3.7	55	105	Included	631-0000-006	631-0000-001
100	631-1311-000	15	4.00	3.75	3.25	3.00	3.19	6.5	55	105	Included	631-0000-006	631-0000-001
150	631-1411-000	15	4.00	4.50	3.88	2.81	3.75	7.4	80	130	Included	631-0000-006	631-0000-001
250	631-1611-000	15	5.75	4.50	3.88	4.75	3.75	10.0	80	130	Included	631-0000-006	631-0000-001
350	631-1811-000	15	5.70	5.25	4.50	4.38	4.38	14.7	80	130	Included	631-0000-006	631-0000-001
500	631-1911-000	15	7.19	5.25	4.50	5.88	4.38	18.2	80	130	Included	631-0000-006	631-0000-001
750	631-2011-000	15	6.50	6.75	5.75	4.25	6.13	30.7	80	130	Included	631-0000-006	631-0000-001

Group MM

VA	Catalog Number	Fig	Dimensions*					Est. Ship Weight	Temp Rise	Insulation Temp.	Secondary Fuse Clip	Terminal Cover	Fuse Block
			A	B	C	D	E						
220/230/240 x 440/460/480 - 110/115/120 x 220/230/240													
1000	631-2112-001	15	7.00	5.25	4.50	5.38	4.38	28.8	80	130	NA	631-0000-006	631-0000-001
1500	631-2212-001	15	7.00	6.75	5.75	4.25	6.13	37.0	115	180		631-0000-006	631-0000-001
2000	631-2312-001	15	7.75	6.75	5.75	5.00	6.13	46.0	115	180		631-0000-006	631-0000-001
3000	631-2412-001	15	8.06	9.00	7.50	5.25	7.50	69.8	115	180		631-0000-006	NA
5000	631-2612-001	15	10.0	9.00	7.50	7.19	7.50	109.9	115	180		631-0000-006	

Note: Housing dimensions subject to change without notice. Consult website or factory where dimensions are critical.

* Secondary fuse clips add 0.5" to C dimension.



Version JE901.0809 Date Feb 09

Industrial Control

Group NN

VA	Catalog Number	Fig	Dimensions*					Est. Ship Weight	Temp Rise	Insulation Temp.	Secondary Fuse Clip	Terminal Cover	Fuse Block
			A	B	C	D	E						
240 x 347 x 380 - 120 x 240													
1000	631-2113-001	15	7.38	6.38	5.44	5.06	5.31	37.6	80	130	NA	631-0000-006	631-0000-001
1500	631-2213-001	15	8.13	6.38	5.44	5.06	5.31	42.8	115	180		631-0000-006	631-0000-001
2000	631-2313-001	15	8.88	6.75	5.75	6.13	6.13	57.5	115	180		631-0000-006	631-0000-001
3000	631-2413-001	15	8.13	9.00	7.50	5.69	7.50	77.1	115	180		631-0000-006	NA
5000	631-2613-001	15	10.38	9.00	7.50	7.56	7.50	116.2	115	180		631-0000-006	

Accessories

Item	Catalog Number	Fig	Estimated Shipping Weight	Dimensions
Primary Fuse Kit	631-0000-001	16	0.3	adds about 1.38" to C dimension
Primary Fuse Covers +	631-0000-002	17	1.0	adds about .25" to C dimension (1.65" total with fuse kit)
Terminal Covers 4 term +	631-0000-004	18	1.0	adds about .25" to C dimension
Terminal Covers 6 term +	631-0000-006	19	1.0	adds about .25" to C dimension

Note: Housing dimensions subject to change without notice. Consult website or factory where dimensions are critical.

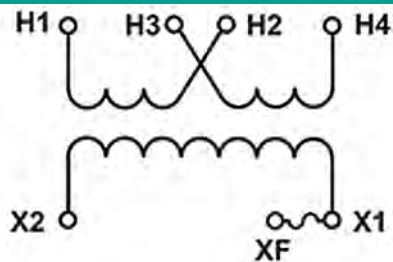
* Secondary fuse clips add 0.5" to C dimension.

+ Catalog number includes covers for 10 transformers.



Group AA Wiring Diagram & Connections

Wiring Diagram

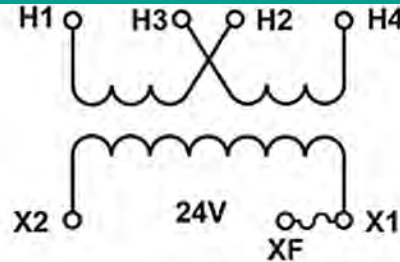


Connections

Primary Volts	Interconnect	Primary Lines Connect To
240/230/220	H1-H3, H2-H4	H1, H4
480/460/440	H2-H3	H1, H4
Sec. Volts	Secondary Lines Connect To	
120/115/110	X2, XF	

Group BB Wiring Diagram & Connections

Wiring Diagram



Connections

Primary Volts	Interconnect	Primary Lines Connect To
480	H2-H3	H1, H4
240	H1-H3, H2-H4	H1, H4
Sec. Volts	Secondary Lines Connect To	
24	X2, XF	

Version JE901 0809 Date Sept 08



1-800-892-3755 www.jeffersonelectric.com

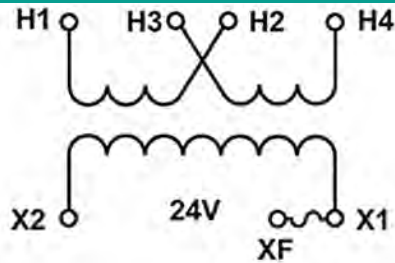
Dry-Type Transformers

10.7

10 Industrial Control

Group CC Wiring Diagram & Connections

Wiring Diagram

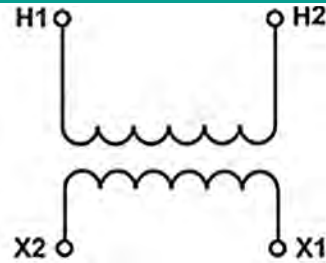


Connections

Primary Volts	Interconnect	Primary Lines Connect To
240	H2-H3	H1, H4
120	H1-H3, H2-H4	H1, H4
Sec. Volts	Secondary Lines Connect To	
24	X2, XF	

Group EE Wiring Diagram & Connections

Wiring Diagram

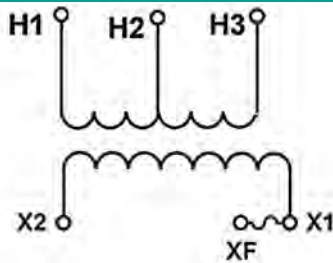


Connections

Primary Volts	Interconnect	Primary Lines Connect To
600/575/550		H1, H2
Sec. Volts	Secondary Lines Connect To	
120/115/110	X2, X1	

Group FF Wiring Diagram & Connections

Wiring Diagram

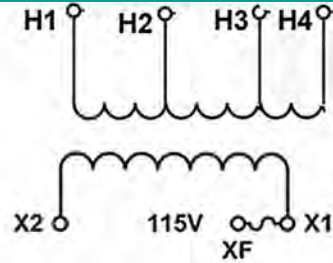


Connections

Primary Volts	Primary Lines Connect To
277	H1, H3
208	H2, H3
Sec. Volts	Secondary Lines Connect To
120	X2, XF

Group GG Wiring Diagram & Connections

Wiring Diagram



Connections

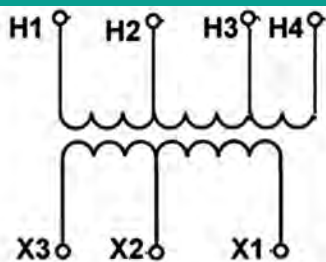
Primary Volts	Primary Lines Connect To	
460	H1, H4	
230	H2, H4	
208	H3, H4	
Sec. Volts	Interconnect	Secondary Lines Connect To
115		X2, XF

Version JE901.0809 Date Sept.08

Industrial Control

Group HH Wiring Diagram & Connections

Wiring Diagram

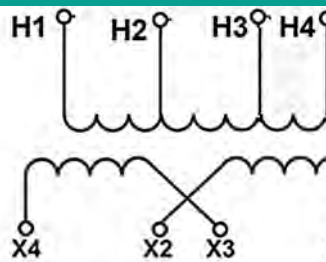


Connections

Primary Volts	Primary Lines Connect To
575	H1, H4
460	H2, H4
230	H3, H4
Sec. Volts	Secondary Lines Connect To
115	X1, X3
95	X2, X3

Group II Wiring Diagram & Connections

Wiring Diagram

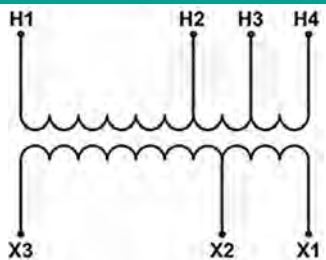


Connections

Primary Volts	Primary Lines Connect To
415	H1, H4
400	H2, H4
380	H3, H4
Sec. Volts	Secondary Lines Connect To
110	X1-X3, X2-X4
220	X2-X3

Group JJ Wiring Diagram & Connections

Wiring Diagram

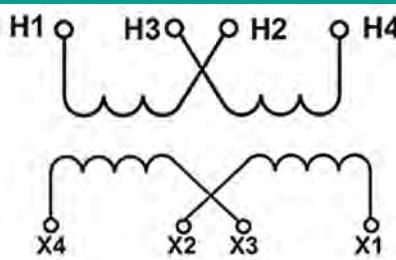


Connections

Primary Volts	Primary Lines Connect To
480/460/440 V	H1, H4
240/230/220 V	H2, H4
208/200 V	H3, H4
Sec. Volts	Secondary Lines Connect To
120/115/110 V	X1, X3
25/24/23 V	X2, X3

Group KK Wiring Diagram & Connections

Wiring Diagram



Connections

Primary Volts	Primary Lines Connect To
480 V	H2-H3
240 V	H1-H3, H2-H4
Sec. Volts	Secondary Lines Connect To
120 V	X1-X3, X2-X4
240 V	X2-X3

Note: For Groups JJ and LL read from left to right to match primary to secondary voltages. For example, on Group JJ the 200V primary can have a 115V or 24V secondary.

Version JE901.0809 Date Sept 08



1-800-892-3755 www.jeffersonelectric.com

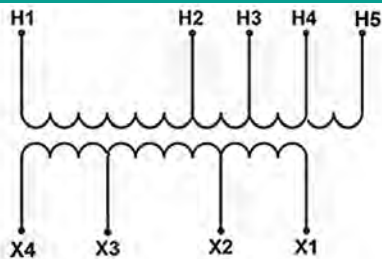
Dry-Type Transformers

10.9

10 Industrial Control

Group LL Wiring Diagram & Connections

Wiring Diagram

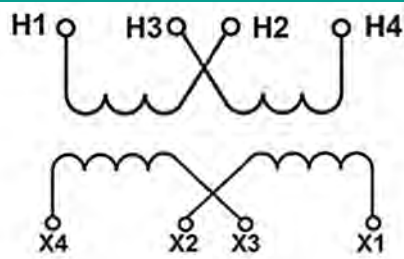


Connections

Primary Volts	Primary Lines Connect To
240/230/220/208 V	H2, H1
416/400/380 V	H3, H1
480/460/440 V	H4, H1
600/575/550/500 V	H5, H1
Sec. Volts	Secondary Lines Connect To
130/125/120/110 V	X4, X1
120/115/110/100 V	X3, X1
99/95/91/85 V	X2, X1

Group MM Wiring Diagram & Connections

Wiring Diagram

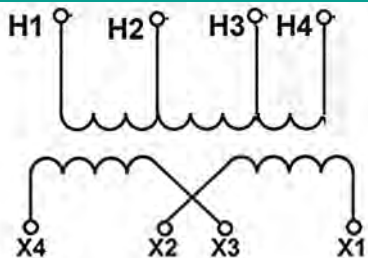


Connections

Primary Volts	Primary Lines Connect To
480/460/440 V	H2-H3
240/230/220 V	H1-H3, H2-H4
Sec. Volts	Secondary Lines Connect To
120/115/110 V	X1-X3, X2-X4
240/230/220 V	X2-X3

Group NN Wiring Diagram & Connections

Wiring Diagram



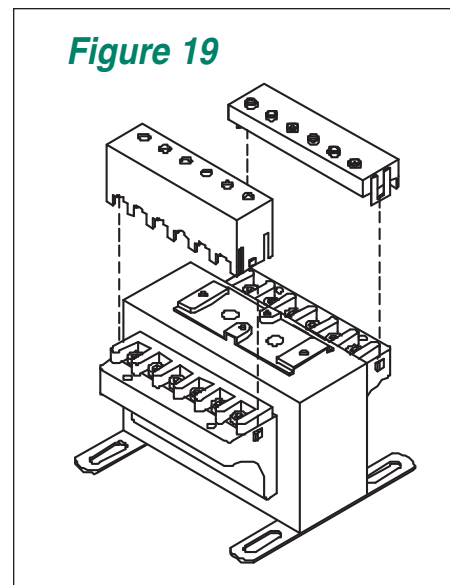
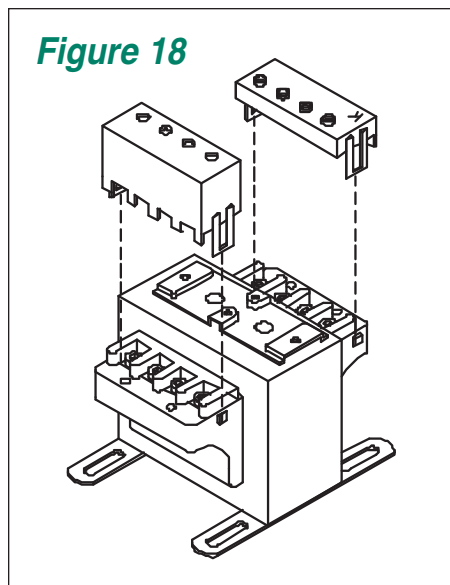
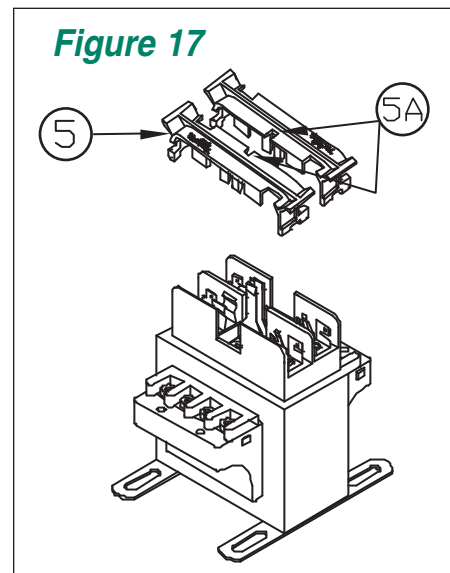
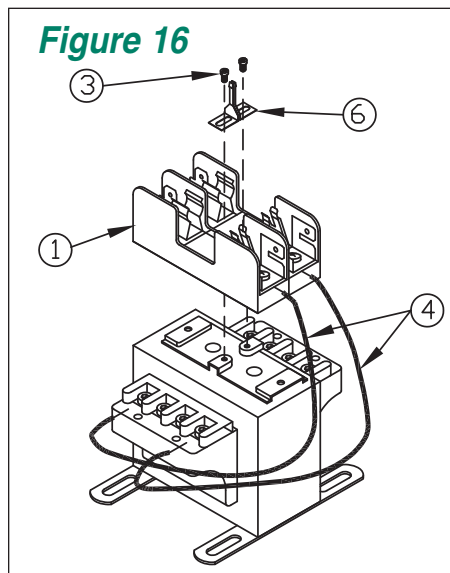
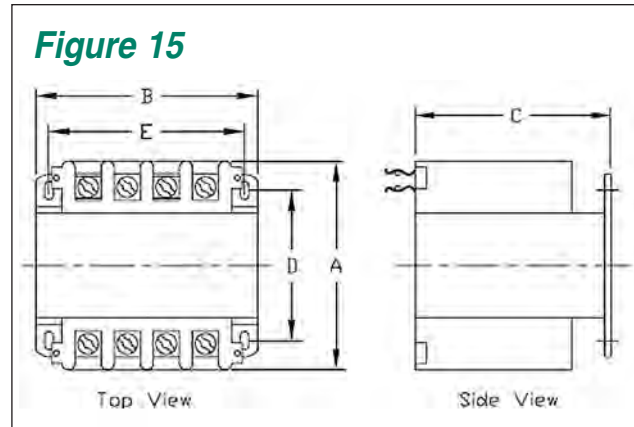
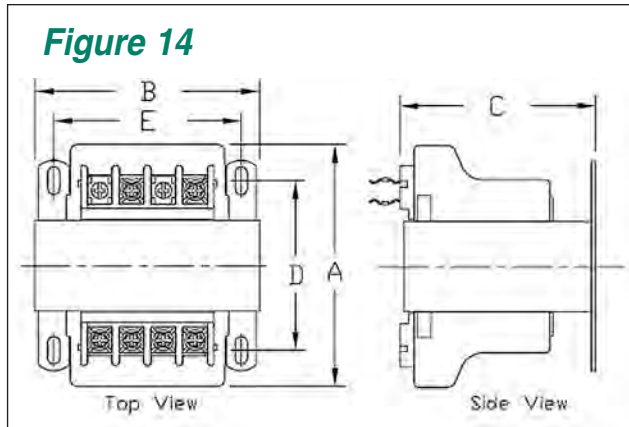
Connections

Primary Volts	Primary Lines Connect To
380 V	H1, H4
347 V	H2, H4
240 V	H3, H4
Sec. Volts	Secondary Lines Connect To
120 V	X1-X3, X2-X4
240 V	X2-X3

Note: For Groups JJ and LL read from left to right to match primary to secondary voltages. For example, on Group JJ the 200V primary can have a 115V or 24V secondary.

Version JE901.0809 Date Sept.08

Industrial Control



Note: Callout numbers 1 to 6 are defined in installation sheets provided with units.

Version JE901.0809 Date Sept 08



1-800-892-3755 www.jeffersonelectric.com

Dry-Type Transformers

10.11

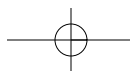
10 Industrial Control

Notes:

Version JE901 0809 Date Sept 08

10.12 | **Dry-Type Transformers** www.jeffersonelectric.com 1-800-892-3755





Lighting Transformers

11



60 Hz for
Lamp Wattages:
100-1800

Contents	
Pool and Spa Lighting	
Overview	11.2
Dimensional Drawings	11.3
Wiring Diagrams	11.3
Selection Charts	
120 V - 12/13/14 V	11.3
Landscape Lighting	
Overview	11.4
Dimensional Drawings	11.5
Wiring Diagrams	11.5
Selection Charts	
120 V - 12/13/14 V	11.5

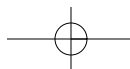
Version JE901 0809 Date Sept 08



1-800-892-3755 www.jeffersonelectric.com

Dry-Type Transformers

11.1



11 Pool and Spa Lighting

Products

- *Lamp Watts: 100 through 1000**

Applications

- *For use with submersible fixtures including swimming pools, water fountains, low voltage circuits near water or other shock hazards*
- *Note: Transformers themselves are not submersible*

Specifications

- *Single-Phase encapsulated*
- *Encapsulated with electrical grade resin*
- *Cores of high quality electrical steel*
- *NEMA 3R-rated enclosures*
- *60 Hz operation*
- *Electrostatically shielded*
- *12, 13, 14 volt taps to compensate for voltage drop on long electrical runs*
- *Heat-cured ASA-61 gray powder coat finish*

Features, Functions, Benefits

- *Resettable power circuit breakers to interrupt if a short or over-voltage occurs*
- *Quiet operation for installation flexibility*
- *Convenient wall mount design with slotted mounting holes*
- *Permanently affixed wiring diagram*

Standards

- *Built in accordance with NEMA, ANSI, UL and CSA standards*

*Options and Accessories

- *Other sizes and voltages available as custom*

Version JE901 0809 Date Sept 08

Pool and Spa Lighting

Single-Phase Encapsulated For Submersible Fixtures

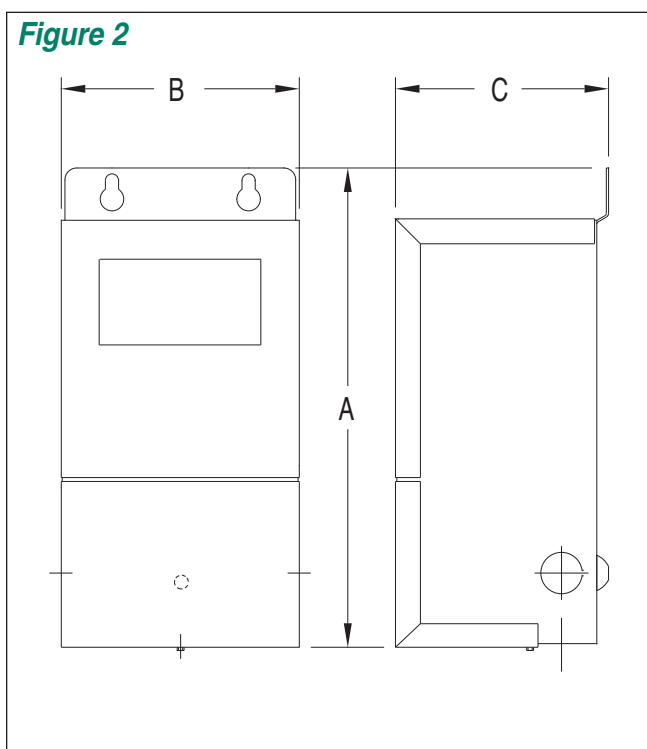
Electrostatic Shield • 60 Hz • 180°C Insulation Class

Lamps Watts	Catalog Number	Fig.	Height A (in.)	Width B (in.)	Depth C (in.)	Wiring Diagram	Est. Ship Wgt. (lbs.)
120 V- 12/13/14 V							
100	411-0938-055	2	9.06	5.06	4.59	S120A	12.50
300	411-0939-055	2	9.06	5.06	4.59		13.00
500	411-0940-055	2	9.06	5.06	4.59		14.00
1000	411-0941-055	2	9.06	5.06	4.59		18.00

Note: Housing dimensions subject to change without notice. Consult website or factory where dimensions are critical.

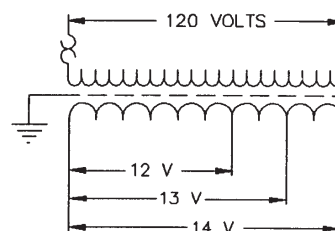


Figure 2



S120A Wiring Diagram & Connections*

Wiring Diagram



Connections

Primary Volts	Primary Lines Connect To
120	H1, H2
Sec. Volts	Secondary Lines Connect To
12	± and 12V
13	± and 13V
14	± and 14V



NOTE: Electrostatic shields are optionally available and not shown in all wiring diagrams. * Insulate unused taps individually.

Version JE901 0809 Date Sept 08



1-800-892-3755 www.jeffersonelectric.com

Dry-Type Transformers

11.3

11 Landscape Lighting

Products

- *Lamp Watts: 300 through 1800**

Applications

- *For outdoor landscape lighting applications*
- *Modular units support optional photocell and timer*

Specifications

- *Primary voltage – 120V; Secondary voltage – 12/13/14/15V*
- *One magnetic breaker per 300W circuit*
- *Electrostatically shielded*
- *6 foot outdoor rated UL listed power cord*

Features, Functions, Benefits

- *Outdoor rated NEMA 3R enclosure with removable hinged door*
- *Removable bottom plate*
- *Black powder coat finish enclosure*
- *Stainless steel enclosure available for harsh environments*
- *Unique mounting bracket for efficient installation*
- *Ample knockouts in the bottom of the unit*
- *1.75 inch access port in bottom of unit*
- *Finger-safe, compression-style terminal blocks each with room to accommodate four 10 gauge wires*

Standards

- *Built in accordance with NEMA, ANSI, UL and CSA standards*

*Options and Accessories

Timer

- *Outdoor rated dial type (#417-0008-TM1)*
- *External timer/photocell combination (#417-0008-TM3)*

Photocell

- *Button style (#417-0008-PS1)*
- *Arm style (#417-0008-PS2)*
- *Remote mount (#417-0008-PS3)*

Version JE901 0809 Date Feb 09

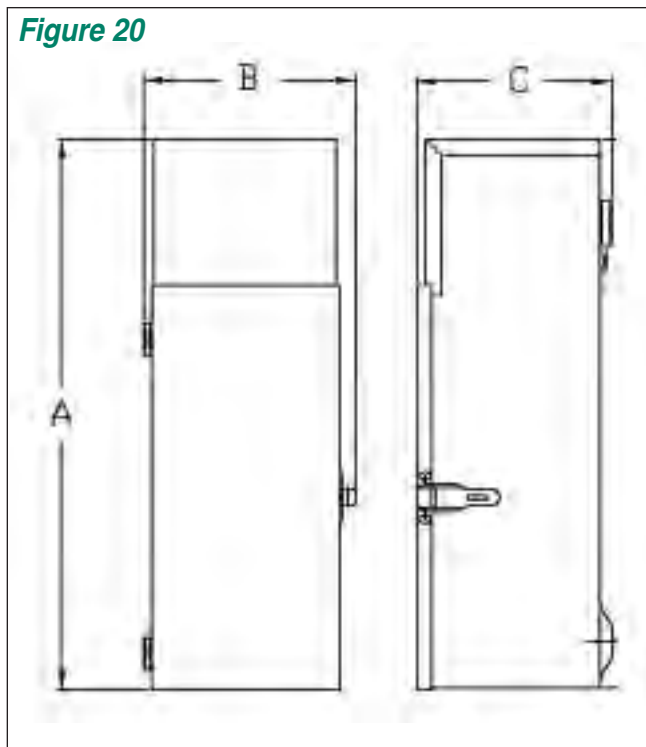
Landscape Lighting

Ratings and Dimensions

Black	Stainless Steel	Input Current Amps	Output Power Watts	Output Circuits	Dimensions in Inches			Weight Lbs
					Height	Width	Depth*	
417-1111-030	417-1111-130	3	300	1	17.6	6.8	6.19	27
417-1121-030	417-1121-130	6	600	2	17.6	6.8	6.19	29
417-1131-030	417-1131-130	9	900	3	18.6	7.8	6.19	34
417-1141-030	417-1141-130	12	1200	4	18.6	7.8	6.19	37
417-1151-030	417-1151-130	15	1500	5	19.6	9.5	7.19	52
417-1161-030	417-1161-130	18	1800	6	19.6	9.5	7.19	57

* Depth includes approximately 3/8" for the mounting bracket.

Figure 20



Version JE901.0809 Date Sept 08

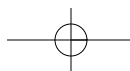


1-800-892-3755

www.jeffersonelectric.com

Dry-Type Transformers

11.5

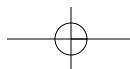


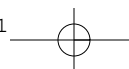
11 Lighting Transformers

Notes:

Version JE901 0809 Date Sept 08

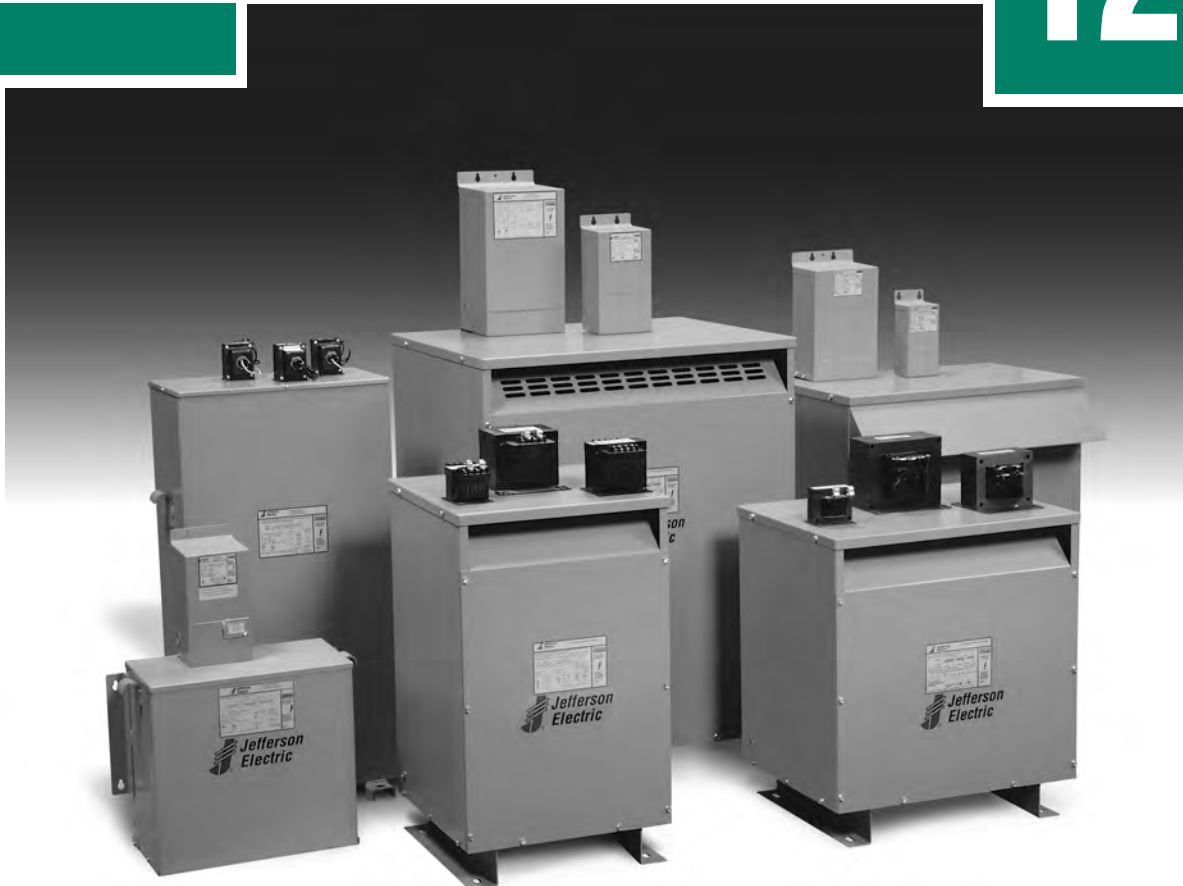
11.6 **Dry-Type Transformers** www.jeffersonelectric.com 1-800-892-3755





Technical References

12



Contents

Installation	12.2
Maintenance	12.3
Protective Equipment	12.4
Fuse Selection	12.5
Insulation and Temperature	12.6
Transformer Sound	12.7
Troubleshooting	12.8
Frequently Asked Questions	12.10
Glossary	12.13

Version JE901 0612 Date Dec 06

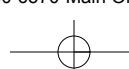


1-800-892-3755

www.jeffersonelectric.com

Dry-Type Transformers

12.1



12 Technical References

Installation

Carefully inspect the transformer before signing the delivery receipt. Any damage should be noted on the receipt and a claim placed against the transportation company. Protective grease placed on terminal connections should not be removed. The grease is a protective coating that prevents the oxidation of the conductor. Bolt the terminal connector firmly to the bus bar, allowing the protective film to be forced out.

Safety

Transformers are provided with access covers to facilitate installation and service. They must be kept securely in place at all times when the transformer is operating.

CAUTION: *Normal operating voltages can be extremely hazardous. Only qualified personnel should install, inspect or service transformers. Disconnect the power before opening the cover or touching any internal parts.*

Storage

Transformers should be stored in a warm, dry location of uniform temperature and in their original packing. If the transformer has been unpacked, all ventilating openings should be covered to keep out dust. Outdoor storage should be avoided, but if this is not possible, the transformer must be protected against moisture and contaminants.

Condensation and moisture can be reduced with heaters. If the transformer has been subjected to moisture, it should be baked out before energizing. This is especially important in transformers of 5 KV or higher.

Taps

If the transformer comes supplied with taps, they will generally have a full capacity rating. A common tap arrangement is two 2.5% taps above FCAN and four 2.5% taps below FCBN nominal voltage. Transformers are shipped with the taps connected for nominal voltage, that is, 480 volts for a 480 volt transformer. The installing electrician must change the taps if the supply voltage differs from the nominal voltage rating.

Connections and Circuits

The transformer should be connected only as described on the nameplate or the wiring diagram inside the wiring compartment cover, or as otherwise specifically authorized by Jefferson Electric.

Transformers without terminal boards, usually the smaller size transformers, provide leads for connections.

IMPORTANT: *Any unused taps or leads must be insulated from each other and taped*

Encapsulated transformers, 2 KVA and smaller, have their turns ratio compensated for losses so that their open circuit voltage is somewhat higher than the load voltage. Machine tool transformers are compensated up to 5 KVA. Using transformers in the reverse direction from which it is designed would result in lower than expected output voltage.

Mounting and Spacing

Dry-type transformers depend on air for cooling, and must be placed so that room air can circulate freely around them. Cabinet style transformers must be mounted so that air can pass freely through the ventilation openings. The transformer space should be kept clear.

Transformers should be spaced at least six inches apart. Transformers rated 30 KVA and larger should be kept at least six inches from walls and ceilings.

Transformers should never be mounted near heat-generating equipment or near heat-sensitive equipment. Transformers should never be placed in a room with hazardous processes, or where flammable gasses or combustible materials are present. Particular care must be taken when mounting in unventilated plenums or in closets with no ventilation. In areas without free moving air, ambient temperatures can rise above acceptable limits, causing the transformer to overheat.

Technical References

Maintenance

Periodic inspection of the transformer should be made, depending on conditions. In most clean, dry installations, once a year is usually sufficient.

After disconnecting the transformer from the power, the cover should be removed and any dirt cleaned out. Screens covering the ventilating openings should be cleaned.

Inspect for loose connections, terminal and splice conditions and for signs of overheating, rust or deteriorating paint.

NEMA Transformer Enclosure Definitions

Type 1	General purpose – indoor.
Type 2	Drip-proof – indoor.
Type 3	Wind blown dust and water – indoor/outdoor.
Type 3R	Rainproof and sleet/ice resistant – outdoor. Meets above type requirements.
Type 3S	Dust-tight, rain-tight, and sleet/ice proof – outdoor.
Type 4	Water-tight and dust-tight – indoor/outdoor.
Type 4X	Water-tight, dust-tight and corrosion resistant – indoor.
Type 5	Dust-tight – indoor.
Type 6	Submersible, water-tight, dust-tight and sleet/ice resistant – indoor/outdoor.
Type 7	Class I, Group (S) A,B,C and/or D – indoor hazardous locations - air-break equipment.
Type 8	Class I, Group (S) A,B,C and/or D – indoor hazardous locations.
Type 9	Class II, Group (S) E,F and/or D – indoor hazardous locations - air-break equipment.
Type 10	Bureau of Mines.
Type 11	Drip-proof and corrosion resistant.
Type 12	Industrial use dust-tight and drip-tight – indoor.
Type 13	Oil-tight and dust-tight – indoor.

Source: NEMA Pub. No. ST20.

Recommended Copper Wire and Transformer Size

HP	Transformer KVA	Distance - Motor to Transformer in Feet					
		100	150	200	300	500	
Single-Phase Motors - 230 Volts							
1½	3	10	8	8	6	4	
2	3	10	8	8	6	4	
3	5	8	8	6	4	2	
5	7½	6	4	4	2	0	
7½	10	6	4	3	1	0	
HP	Volts	Transformer KVA	Distance - Motor to Transformer in Feet				
			100	150	200	300	500
Three-Phase Motors - 230 & 460 Volts							
1½	230	3	12	12	12	12	10
1½	460	3	12	12	12	12	12
2	230	3	12	12	12	10	8
2	460	3	12	12	12	12	12
3	230	5	12	10	10	8	6
3	460	5	12	12	12	12	10
5	230	7½	10	8	8	6	4
5	460	7½	12	12	12	10	8
7½	230	10	8	6	6	4	2
7½	460	10	12	12	12	10	8
10	230	15	6	4	4	4	1
10	460	15	12	12	12	10	8
15	230	20	4	4	4	2	0
15	460	20	12	10	10	8	6
20	230		4	2	2	1	000
20	460		10	8	8	6	4
25	230		2	2	2	0	000
25	460		8	8	6	6	4
30	230		2	1	1	00	0000
30	460		8	6	6	4	2
40	230		1	0	00	0000	300
40	460		6	6	4	2	0
50	230		1	0	00	0000	300
50	460		4	4	2	2	0
60	230		1	00	000	250	500
60	460		4	2	2	0	00
75	230		0	000	0000	300	500
75	460		4	2	0	00	000

Source: EASA Handbook.

Version JE901 0612 Date Dec 06



12 Technical References

Protective Equipment

The importance of protecting your power delivery system cannot be overstated. The system must be protected against short circuits, surges caused by lightning, switching and overheating. Equipment is available to provide this protection, but it must also be adequately sized and properly installed. Failure to do so could damage the transformer and invalidate its warranty.

Protective equipment includes circuit breakers and fuses.

The selection and placement of protective equipment within the system is the responsibility of the end user.

Circuit Breakers

When any component of a circuit fails, there is nothing to limit current flow except the resistance of the circuit conductors and the resistance of the fault itself. The currents in these situations can be extremely large and destructive, making it imperative to interrupt the circuit as quickly as possible.

Circuit breakers are designed to react to a fault by making a physical separation in the current-carrying or conducting element by inserting an insulating medium. Breakers come in different types, depending on the insulating medium used. While the most common insulation is oil, air is used in some 600 Volt class circuits. For higher voltages and larger capacities, the insulating medium might be a vacuum or an inert gas such as sulphur hexafluoride.

Specifications for a circuit breaker will depend on the operating voltage of the circuit, the normal operating or maximum load current, and the maximum abnormal or fault current to be interrupted. Circuit breakers are rated in KVA or MVA and express the ability of the breaker to withstand short circuit forces.

Circuit breakers must withstand large inrush currents that result when voltage is initially switched on. These currents can be 20 to 30 times the rated transformer current even with no-load. Therefore, breakers must have built-in time delay for the first 5 to 10 cycles to avoid tripping under "turn-on" currents.

Fuses

The most common protective device in use, the fuse is basically a circuit breaker that works only once and then must be replaced. When current exceeds the predetermined current value, a fusible link melts, opening the circuit.

When voltage is initially switched on, a large inrush current results, being greatest in the first half-cycle of operation, or approximately .01 second. This current becomes less severe over the next few cycles, or approximately .1 second until the transformer is operating normally. Because of inrush current, fuses are often selected to withstand as much as 25 times primary rated current for .01 second, and 12 times primary rated current for .1 second.

Technical References

Fuse Selection

The tables provide guidance for selecting fuses when the maximum voltage in the circuit is 600 Volts or less. These tables are included in Article 450-3 of the National Electrical Code covering over-current protection of transformers.

If primary protection only is required, use Table 1. If both primary and secondary protection are required, refer to Table 2.

IMPORTANT: *These tables are to be used as a guide only. The final determination of application is the responsibility of the end user.*

Primary Fuse Selection

Primary fuse selection is made according to rated primary current (I_{pri}). To determine I_{pri}, the transformer rating (VA or KVA) and primary voltage (V_{pri}) must be known as well as whether the transformer is single- or three-phase. With this information, use the appropriate formula to determine I_{pri}.

Once I_{pri} is known, select fuses according to Table 1 or 2 above.

Primary Fuse Only - Table 1

Transformer Primary Amperes	Maximum Primary Fuse % Rating
9 or More	125*
2 or 9	167
Less than 2	300

**If 125% does not correspond to a standard ampere rating, the next higher standard rating described in NEC Article 240-6 shall be permitted.*

Primary and Secondary Fuses - Table 2

Transformer Secondary Amperes	Maximum % Rating	
	Primary Fuse	Secondary Fuse
9 or More	250	125*
Less than 9	250	167

Secondary Fuse Selection

Secondary fuse selection is made according to rated secondary current (I_{sec}). To determine I_{sec}, the transformer rating (VA or KVA) and secondary voltage (V_{sec}) must be known as well as whether the transformer is single- or three-phase. With this information, use the appropriate formula to determine I_{sec}.

Once I_{sec} is known, select fuses according to Table 2 above.

Primary Fuse Formulas

Single-Phase Transformers

$$I_{pri} = \frac{\text{Transformer VA}}{V_{pri}}$$

OR

$$I_{pri} = \frac{\text{Transformer VA}}{V_{pri}} \times 1000$$

Three-Phase Transformers

$$I_{pri} = \frac{\text{Transformer VA}}{1.73 \times V_{pri}} \times 1000$$

Secondary Fuse Formulas

Single-Phase Transformers

$$I_{sec} = \frac{\text{Transformer VA}}{V_{sec}}$$

OR

$$I_{sec} = \frac{\text{Transformer VA}}{V_{sec}} \times 1000$$

Three-Phase Transformers

$$I_{sec} = \frac{\text{Transformer VA}}{1.73 \times V_{sec}} \times 1000$$

Version JE901 0612 Date Dec 06



12 Technical References

Insulation and Temperature

All Jefferson Electric transformers are designed and manufactured with the best quality insulation available. There are classes of insulation systems for different temperatures as defined by NEMA and ANSI. Insulation classes are rated in °C rise above a specific ambient of 40°C maximum. A transformer having a specific class of insulation, for example Class 220, can have an average winding temperature rise of 150°C with a maximum hot spot temperature rise of 180°C. If the room ambient temperature is 40°C, then the total temperature of the hottest spot would be 220°C. Jefferson Electric transformers are designed to operate at rated load and voltage in maximum room ambient temperatures of 40°C, average room ambient temperature not to exceed 30°C, and at altitudes not to exceed 3300 feet in accordance with NEMA standards.

Insulating Classifications

The designations for insulation systems are numerical classifications based on temperature ratings. Transformer ratings are based on temperature rise. The accompanying table shows the designations.

Overloads

Overloads exceeding the maximum allowable insulation temperature can be tolerated, provided the overload is of short duration and is preceded and followed by a period of operation at less than rated KVA (refer to ANSI C57.96-1989, Tables 5,6,7). Overloading should be avoided unless approval is obtained from the Jefferson Electric engineering department.

Transformer and Insulation Systems Ratings

Ventilated

Insulation Class	Temperature Rise	Ambient Temperature	Hot Spot Allowance
105	55°C	40°C	10°C
150	80°C	40°C	30°C
180	110°C	40°C	30°C
220	150°C	40°C	30°C

Encapsulated

Insulation Class	Temperature Rise	Ambient Temperature	Hot Spot Allowance
105	70°C	25°C	10°C
130	95°C	25°C	10°C
180	135°C	25°C	20°C

Control Transformers

Insulation Class	Temperature Rise	Ambient Temperature	Hot Spot Allowance
105	55°C	40°C	10°C
130	80°C	40°C	10°C
155	100°C	40°C	15°C
180	120°C	40°C	20°C

High Ambient Temperatures

Ambient temperatures above 30°C average over a 24-hour period and 40°C maximum require either a larger KVA rating or a special low temperature rise transformer. A 150°C rise air cooled transformer can also be derated using the formula of .4% KVA reduction for each degree centigrade above 30°C ambient temperature.

Altitude Correction

For transformers above 3300 feet, reduce the KVA rating .3% for each 330 feet above 3300 feet.

Version JE901 06:12 Date Dec 06

Technical References

Transformer Sound

Transformers, like other electromagnetic devices, produce a "hum" caused by the alternating flux in the transformer core. This "hum", known as magnetostriction, is primarily produced at a fundamental frequency of twice the applied frequency. The relative loudness depends on the construction of the transformer, the manner of installation and the ambient sound level at the site.

The sound produced by a transformer has a fundamental frequency of 120 Hz, accompanied by harmonics of 240, 360, 480, 600, etc.

Controlling Transformer Sound

Sound control becomes more important as power demands increase and transformers are placed closer to their loads. Planning of transformer placement and specification is especially important in designing high rise apartments, hospitals and office buildings.

Proper installation can significantly reduce transformer noise. For a quiet installation:

- Consult your architect about the location of the transformer while the building is being designed.
- Install the transformer as far as possible from areas where the sound could be objectionable.
- Avoid placing near multiple reflective surfaces such as in a corner, near a ceiling or floor, or in a hallway.
- Place sound-dampening pads between the transformer and the mounting surface. (Pads may be neoprene with sandwiched cork material or spring loaded with a rubber base.)
- Use flexible conduit couplings between the transformer and the wiring system.
- Mount the transformer on walls or structural members sufficient to support its weight.
- To avoid amplifying the sound, mount the transformer on a surface with as large a mass as possible.

Judge transformer sound only when the building is finished, occupied and functioning.

Sound Testing Standards

NEMA ST 1-4 (ANSI-C89.1) section 2.7 covers "Audible Sound Level Test." For a thorough understanding of these tests it should be read in its entirety.

Briefly, the transformer is tested at its rated frequency and voltage under no-load conditions in a room which is 10 feet larger on all sides than the transformer. The ambient sound level of the room must be at least 5 db, and preferably 10 db, below the ambient level plus the transformer level. Five sound readings are taken with an approved sound meter one foot from each side of the transformer enclosure and one foot above the enclosure. The sound rating is the average of these five readings.

For three-phase transformers, the NEMA maximum allowable averages of the readings in decibels are shown in the chart below.

Transformer NEMA Maximum Single and Three-Phase db Ratings	
KVA Rating	600V Class
0 - 9	40
10 - 50	45
51 - 150	50
151 - 300	55
301 - 500	60
501 - 700	62
701 - 1000	64

Version JE901 0612 Date Dec 06

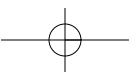


12 Technical References

<i>Condition</i>	<i>Possible Cause</i>	<i>Suggested Remedy</i>
Hot transformer	High ambient temperature	Improve ventilation or relocate unit to cooler location.
	Overload	Reduce load; reduce amperes by improving power factor with capacitors; check for circulating currents for paralleled transformers - different ratios or impedances; check for open phase in delta bank.
	High voltage	Change circuit voltage, taps.
	Insufficient cooling	If other than naturally cooled, check fans, pumps, valves and other units in cooling systems.
	Winding failure – incipient fault	See "No voltage - unsteady voltage" below.
Noisy transformer	Short-circuited core	Test for exciting current and no-load loss; if high, inspect core, remove and repair; check core bolt, clamps and tighten; check insulation between laminations; if welded together, return to factory for repair or replacement.
	High harmonic loads	Measure neutral current - replace with K-rated transformer
Noisy transformer	Overload	See "Hot transformer" above.
	Metal part ungrounded, loose connection	Determine part and reason; check clamps, cores and parts normally grounded for loose or broken connections, missing bolts or nuts, etc.; tighten loose clamps, bolts, nuts; replace missing ones.
	External parts and accessories in resonant vibration	Tighten items as above; in some cases, loosen to relieve pressure causing resonance and install shims.
No voltage – unsteady voltage	Incipient fault – core or winding	See above under "Hot transformer."
	Winding failure - lightning; overload; short-circuit from foreign object or low strength dielectric	Check winding; remove foreign object or damaged material; repair or replace parts of insulation materials.
Rust and paint deterioration	Weather, pollution, corrosive or salt atmosphere; overloads	Remove rust and deteriorated paint; clean surfaces; repaint with proper paints and sufficient coatings.
	Excessive heating discoloration	If excessive heating discoloration occurs, check sizing, input voltage, or loading amps.

Version JE901 0612 Date Dec 06





Technical References

Condition	Possible Cause	Suggested Remedy
Hot neutral line	Overload	Too small neutral conductor: replace. Severe unbalance between phase: rebalance and equalize loads.
	One leg of wye bank open	Check associated fuse. If blown, remove cause and replace. Check for open circuit in winding of transformer in bank. Measure odd harmonic amps with RMS meter.
Voltage unbalanced	Open neutral unbalanced loads	Check neutral connections. See "Hot neutral line" above.
Voltages high and unbalanced	Open neutral on wye bank ground in winding of one transformer in wye	Check neutral connections and load balance. Check values of voltages between phases and phase-to-ground voltages. Vector should indicate source of trouble.
No voltage – one phase of delta connected bank	Grounds on two legs of delta (delta collapse - loads "single phasing")	Remove grounds from at least one leg of delta source.
Overloads on two delta bank	Open in third transformer of bank; operating in open delta	Check fuses on supply to their bank; check winding of transformers in third transformer for continuity.
Low voltage on two phases of delta	Open in one phase of delta supply; two transformers now connected across one same phase	Check fuse on supply; check supply circuit back to source for open circuit.

Version JE901 0612 Date Dec 06

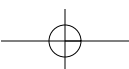


1-800-892-3755

www.jeffersonelectric.com

Dry-Type Transformers

12.9



12 Technical References

Frequently Asked Questions (See Also Glossary of Terms)

What will happen if transformers are operated at non-nameplate voltages?

A transformer is designed using specific ratios that relate to the rated KVA, primary voltage and secondary voltage proportionally. Operating a transformer above or below the nominally designed primary voltage will reflect a proportional increase or decrease in secondary output levels. Extreme caution must be observed when overvoltage levels exist. Excessive input voltage will cause higher core losses, increased noise and elevated temperatures. Overvoltages for any extended period of time have a significant effect on insulation breakdown and transformer failures. Transformers can be specifically designed for extreme voltage conditions if initial specifications state those requirements.

Can transformers be operated at different frequencies?

A 60 Hz design is physically smaller than a 50 Hz design. DO NOT use 60 Hz rated transformers on 50 Hz service. Without special designs, higher losses and greater heat rise will result. Operating 60 Hz transformers at higher frequencies may simply provide less voltage regulation.

Can transformers be used in parallel?

It is very common for transformers to be placed in parallel service. To provide maximum efficiency, voltage and impedance values must match closely for each transformer involved. A failure to match voltage and impedances will cause unbalanced loading for the transformers and may lead to overheating or premature failure.

What would be the result of overloading dry type transformers?

All Jefferson Electric transformers are designed to accommodate short periods of overloading. As the overload becomes excessive and the duration increases, the transformer will experience a percent loss of life.

Prolonged overloading generates excessive heating which results in insulation deterioration and ultimately transformer failure. Contact your Jefferson Electric application engineer to determine loading for your unique application.

What is meant by a transformer's temperature rise?

A transformer's rated temperature rise (degrees Celsius) is the average temperature of the transformer's windings over an ambient temperature of 40°C. In other words, the average winding temperature = ambient + temperature rise.

Why is the transformer case hot?

Transformers are designed to operate at a specific load. As transformers are overloaded, losses generated increase, resulting in a potential for case heating. If a transformer is properly sized for a specific application, no excessive heating should be present.

Why do transformers make a noise?

The hum is caused by alternating flux in the core and is known as magnetostriction. The humming can be minimized in manufacturing and through the use of dampening pads when installed.

Version JE901 0612 Date Dec 06

Technical References

Can I achieve specific sound levels in a transformer?

Whenever noise is a concern, but before selecting a transformer, assure yourself that the sound levels represented have been measured in accordance with the NEMA standards. If your requirement is lower than that available from the manufacturer's standard product, request a specific sound level on your RFQ or bid.

What about transformers in reverse?

Most transformers can be connected in reverse, to proper voltages, and will provide the voltages as specified on the nameplate. However special conditions apply to transformers rated 2KVA or less and for transformers rated 150 KVA or larger. Since smaller transformers (2KVA or less) are designed with compensation to ensure proper output voltage when connected normally. The output voltage may be less than expected when wired in reverse. Larger transformers (150 KVA or larger) may have a high in-rush current on startup that could trip a standard circuit breaker

CAUTION: *When connecting a Delta-Wye transformer in reverse the primary should be connected as a Delta (ignoring the X0 terminal). Connecting the X0 on the primary may cause unsafe conditions in fault situations.*

What type of terminations are provided on Jefferson Electric transformers?

Jefferson Electric dry type transformers are provided with the following primary and secondary terminations:

Encapsulated	wire leads
Ventilated	terminals
Machine Tool	terminals
Control	leads
Others	to order

Do Jefferson Electric transformers carry CSA certification?

Any Jefferson Electric transformer sold in Canada has been certified to the Canadian Standards Association's latest specifications. Units certified by the Canadian Standards Association are marked with the CSA logo. Those certified by Underwriter's Laboratory are marked with the C-UL logo

How do I determine the electrical load?

Obtain the following standard nameplate or instruction manual data for the equipment (the load) to be powered:

- Voltage required by the equipment
- Amperes or KVA capacity required by the equipment
- Required frequency of source voltage in Hz (cycles per second)
- Determine whether the load is designed to operate on a single- or three-phase supply

What is the supply voltage?

The supply voltage may be higher or lower than the voltage required by the load. However, the frequency of the two may not differ.

If your load ratings are not expressed in KVA, use the load voltage and amperage to determine the KVA.

For single-phase: $VA = \text{volts} \times \text{amperes}$

$$KVA = VA/1000$$

For three-phase: $VA = \text{volts} \times \text{amperes} \times 1.73$

$$KVA = VA/1000$$

Once you have a KVA rating, then select a transformer from the charts in the appropriate section of this catalog by matching the primary and secondary voltages determined above.

What is an isolating transformer?

In an isolating transformer, the primary and secondary windings are connected magnetically, but not electrically. Also referred to as an "insulating" transformer.

Can I connect a single-phase transformer to a three-phase source?

Yes, and the transformer output will be single-phase. Simply connect any two wires from a 3- or 4-wire source to the transformer's two primary leads. Three single-phase transformers can be used for three-phase applications. They can be used in delta-connected primary and wye or delta-connected secondary. To avoid an unstable secondary voltage, NEVER connect wye primary to delta secondary.

Version JE901 0612 Date Dec 06



12 Technical References

Can I use a transformer to change three-phase to single-phase?

It is not possible for a transformer to present a balanced load to the supply and deliver a single-phase output. Changing three-phase to two-phase, and vice-versa, can be done using special circuitry with standard dual-wound transformers.

What is voltage regulation in a transformer?

The voltage difference between loaded and unloaded output. To provide the proper secondary load voltage, extra primary windings cause the no-load secondary voltage to be 3-5% higher than the load voltage. Also known as "compensated windings."

How do I know when the temperature rise is too high?

Touch is a poor indicator of proper transformer operating temperature. Properly designed transformers can reach 50°C (122°F) above ambient temperature. In an ambient temperature of 20°C (60°F), the total temperature can reach 70°C (190°F), which is too hot to touch. Thermometers are the best way to determine the temperature.

Do I need special transformers for high ambient temperatures?

If you have an immediate need that cannot wait for a custom-built transformer, you can de-rate a standard transformer. For each 10°C above 30°C, de-rate the maximum loading by 4% (30°C = 100%; 40°C = 96%; 50°C = 92%; 60°C = 88%).

What is a non-linear (K-factor) transformer?

A transformer that is designed to handle the odd harmonic current loads caused by much of today's modern office equipment.

A non-linear transformer has a K-factor rating that is an index of its ability to supply harmonic content in its load current while remaining within its operating temperature limit.

What is a drive isolation transformer?

A drive isolation transformer is designed for use with motor drives. It must isolate the motor from the line and handle the added loads of the drive-created harmonic current. It is important to heed the drive manufacturer's recommendations for transformer KVA.

What is a buck-boost transformer?

Buck-boost transformers are single-phase isolated distribution transformers having four windings instead of two. They can be connected as an autotransformer to buck (reduce) or boost (raise) the line voltage from 5 - 20%. Typical reduced secondary voltages are 12, 16, 24, 32, or 48 volts. Commonly found raised secondary voltages are 208 to 230 or 240 volts.



Technical References

Glossary

A

ANSI American National Standards Institute. A recognized body which approves standards for transformers. ANSI C 57.12 series contains the standards most often used for dry type transformers.

Air-Cooled A transformer cooled by the natural circulation of air over and/or through the core and coils.

Alternating Current (or voltage) Current that alternates regularly in direction, is periodic and has an average value (over a period of time) of zero.

Ambient Noise Level The existing or inherent sound level of the area surrounding a transformer installation. Measured in decibels.

Ambient Temperature The temperature of the air surrounding the transformer.

Ampacity The current-carrying capacity of an electrical conductor or device.

Ampere The practical unit of electric current.

Attenuation Decrease in signal voltage or power.

Autotransformer A transformer in which part of one winding is common to both the primary and the secondary circuits associated with that winding.

B

BIL Basic Insulation Level. A measure of the ability of the insulation system to withstand very high voltage surges. For example, a 600 volt class transformer has a 10 KV BIL rating.

Banked Two or more single-phase transformers connected together, or banked, to supply power. Three single-phase transformers banked together will produce a KVA capacity of three times the nameplate rating of the individual single-phase transformers. For example, three 5 KVA single-phase transformers connected together for a three-phase load will have a 15 KVA capacity.

C

CE Mark to indicate third party approved or self-certification to European Community requirements.

CSA Canadian Standards Association. The Canadian equivalent of Underwriter's Laboratories (UL).

CUL Mark to indicate UL certification to CSA standards.

Celsius Same as Centigrade. To convert Centigrade to Fahrenheit, use the following formula:
 $^{\circ}\text{F} = 1.8 \times ^{\circ}\text{C} + 32.$

Coil A number of turns of conductor wound as a coil.

Compensated Transformer A transformer with a turns ratio which provides a higher rated voltage at no-load and rated voltage at rated load. Normally used on units rated 2 KVA or smaller.

Continuous Duty The service requirement that demands operation at a constant load for an indefinite period of time.

Continuous Rating The load that a transformer can handle indefinitely without exceeding the specified temperature rise.

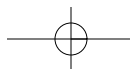
Control Transformer Usually referred to as an Industrial Control Transformer. Designed for good voltage regulation characteristics when low power factor and/or large inrush currents are drawn (5 to 15 times normal).

Conductor Losses Losses in the transformer winding that are incidental to the carrying of the load. These losses include those due to resistance as well as to stray and eddy currents.

Core The steel that carries the magnetic flux in a transformer.

Core Loss Losses caused by a magnetization of the core and its resistance to magnetic flux.

Cycle One complete sequence of values of an alternating quantity, including a rise to maximum in one direction, a return to zero, a rise to a maximum in the opposite direction, and a return to zero.



12 Technical References

D

Decibel (db) A unit used to express the magnitude of a change in signal or sound level, either an increase or a decrease.

Delta Connection A method used for connecting the three windings of a three-phase transformer (or three single-phase transformers). The windings are connected in series, the three-phase supply being taken from or supplied to the junctions.

Delta Wye The method of connection for both primary and secondary windings of a three-phase transformer bank.

Dielectric Tests A series of tests conducted at a much higher than rated nameplate voltage to assure the integrity of insulating materials and electrical clearances.

Distribution Transformer Any transformer rated between 3 and 500 KVA and a primary voltage of 601 volts or less.

Double Wound Transformer See Isolating Transformer.

Drive Isolation Transformer A transformer designed to withstand the additional heat and mechanical stress caused by DC drives.

Dry Type Transformer A transformer cooled by a medium other than a liquid, usually through the circulation of air.

Dual Winding A winding that consists of two separate windings which can be connected in series to handle a specific voltage and KVA or in parallel to handle the same KVA at one-half the series connected voltage.

E

Eddy Currents Additional currents caused by a time varying magnetic field.

Effective Voltage or Current 0.707 times the peak value of AC voltage or current. Effective value is also designated RMS value (Root Mean Square). When AC voltage is referred to, the effective value is understood unless otherwise noted. Symbols "E" and "I" without subscripts indicate effective values.

Efficiency The efficiency of a transformer is the ratio of its power output to its total power input.

Electrostatic Shield A grounded conductor placed between the primary and secondary winding to greatly reduce or eliminate line-to-line or line-to-ground noise. Often referred to as a "Faraday shield."

Excitation Current The steady rate current that keeps the transformer energized after the inrush has dissipated, with all other windings open-circuited. Also called "magnetizing" or "no-load current."

Exciting Wattage The no-load loss of a transformer.

F

FCAN and FCBN Taps Full Capacity Above Nominal and Full Capacity Below Nominal. The FCAN designation is used to indicate that a transformer will deliver rated KVA when connected to a voltage source which is higher than rated voltage. The FCBN designation indicates that a transformer will deliver rated KVA when connected to a voltage source which is lower than rated voltage.

Fan Cooled A means of accelerating heat dissipation to lower the temperature rise of the transformer. This has the effect of increasing the transformer rating.

FL Full-load

Frequency The number of complete cycles per unit for a periodic quantity such as alternating current, sound waves or vibrating objects.

Fuse An overcurrent protective device with a circuit-opening fusible member which is directly heated and severed by the passage of overcurrent through it, or by a fault.

G

Ground A conducting path, whether intentional or accidental, between an electric circuit or equipment and the earth, or some other conductor.

Grounded Connected to the earth or some other conductor.

Technical References

H

HP Horsepower. Energy required to raise 33,000 pounds one foot in one minute. Equals 746 watts, or .746 KW.

Harmonic A sinusoidal waveform with a frequency that is an integral multiple of the fundamental 60 Hz frequency.

60 Hz	Fundamental
120 Hz	2nd Harmonic
180 Hz	3rd Harmonic
240 Hz	4th Harmonic
etc.	

Current waveforms from non-linear loads appear distorted because the non-linear waveform is the result of adding harmonic components to the fundamental current.

Harmonic Distortion Non-linear distortion of a system characterized by the appearance in the output of harmonic currents when the input is sinusoidal.

Harmonic Distortion, Total The square root of the sum of the squares of all harmonic currents present in the load, excluding the 60 Hz fundamental. Usually expressed as a percent of the fundamental.

Hertz (Hz) Cycles per second.

High Voltage Windings In a transformer with two windings, designates the winding with the greater voltage. Usually marked with an "H" designation.

Hysteresis Tendency of a magnetic substance to persist in any state of magnetization.

I

Impedance Total opposition of a component or circuit to the flow of an alternating or varying current (symbol Z).

Inductance That property of a circuit or circuit element opposing a change in current flow (symbol L). Measured in Henrys.

Input The power or signal fed into an electrical device, or to the terminals involved.

Inrush Current The initial high peak of current during the first few cycles of energization which can be 30 to 40 times the rated current.

Isolating Transformer Transformer in which input winding(s) connected to the line are completely isolated from those connected to the load.

Insulation Material with high electrical resistance.

Insulator Device used for supporting or separating conductors of electricity.

Insulating Transformer Another term for isolation transformer.

K

K-Factor A numerical value taking into account both the magnitude and frequency of the component of a current waveform. Used to indicate a full-rated transformer specifically designed to handle non-linear loads.

Kilowatt (KW) 1,000 Watts.

KWH Kilowatt hour, one kilowatt for one hour.

KVA Kilovolt-ampere, or thousand volt-ampere. When multiplied by the power factor, will give kilowatts, or KW.

L

Linear Loads Loads where the current waveform conforms to that of the applied voltage, or loads where a change in current is directly proportional to a change in applied voltage. For example: resistance heating, incandescent lighting, water heater.

Lamination Thin sheets of steel making up the core of the transformer.

Line Voltage The voltage of the power line.

N

Non-Linear Loads Loads where the current waveform does not conform to that of the applied voltage, or where a change in current is not proportional to change in applied voltage. For example: computer power supplies, motor drives, fluorescent lighting.

Non-Ventilated Construction The core and coil assembly is mounted inside an enclosure which has no ventilation openings.

12 Technical References

P

Potted The core and coil assembly is completely encapsulated (contained within protecting material) with a resin-sand compound and contained in a metal enclosure.

Power Factor (PF) A capacitive or inductive circuit condition that results in the applied current leading or lagging the applied voltage.

Peak Voltage The voltage or current of an AC sinusoidal wave when it reaches its peak or maximum level. This occurs twice and lasts for only a fraction of the cycle. Direct current voltage is peak voltage at all times.

S

Short Circuit A low resistance connection, usually accidental, across part of a circuit, resulting in excessive current flow.

Sinusoidal Having the form of a sine (or cosine) wave.

Step-Up/Step-Down Transformers A transformer can either step up or step down voltage. A step-up transformer is one in which the output voltage is greater than the input voltage. With a step-down transformer, the input voltage is greater than the output voltage.

T

Taps Incoming plant voltage varies according to the distance from the substation and other factors. Taps allow a distribution transformer to provide secondary voltage as close as possible to the desired operating voltage. Taps are usually supplied on the primary winding to allow matching of the supply voltage to the voltage rating of the transformer connection. A tap position above the nominal connection will lower the secondary output and vice-versa.

Transformer Regulation The percentage difference between voltage at the secondary terminals under no-load condition versus voltage under full-load. This value depends on the load power factor and is usually reported at 1.0 PF and 0.8 PF.

Turn Ratio The relationship between the number of turns on the transformer's two windings. Voltage is always transformed in exact accordance to this ratio. The amperes, or amount of current, changes in an inverse ratio to the turns ratio. When voltage increases, current decreases in the same proportion, and vice-versa.

U

UL Underwriter's Laboratories. A non-profit safety testing organization.

V

Ventilated Providing circulation of external air.

Ventilated Enclosure Enclosure with openings which allow air to flow directly over the core and coil assembly for cooling.

Volt-Amperes Transformers are rated in volt-amperes (the product of volts and amperes in the input winding). The capacities of very large transformers are rated in thousands of volt-amperes (kilovolt-amperes or KVA) and in millions of volt-amperes (megavolt-amperes or MVA). For all practical purposes, input KVA is equal to output KVA.

W

Watt Unit of electrical power when the current in the circuit is one ampere and the voltage is one volt.

Weathershields When added to ventilated enclosures, allow indoor-rated units to be situated outdoors, changing the enclosure rating to NEMA 3R.

Index

Suffix charts on pages 3.4, 4.4, 5.6, and 8.6 will provide the appropriate numbers for ordering units with electrostatic shields, aluminum or copper windings, low temperature rise, and/or K-factor requirements.

Catalog No. Page**223**

223-0031-651 7.4
 223-0031-652 7.4
 223-0031-653 7.4
 223-0031-654 7.4
 223-0031-655 7.4
 223-0031-656 7.4
 223-0032-651 7.4
 223-0032-652 7.4
 223-0032-653 7.4
 223-0032-654 7.4
 223-0032-655 7.4
 223-0032-656 7.4
 223-0033-651 7.4
 223-0033-652 7.4
 223-0033-653 7.4
 223-0033-654 7.4
 223-0033-655 7.4
 223-0033-656 7.4
 223-0034-651 7.4
 223-0034-652 7.4
 223-0034-653 7.4
 223-0034-654 7.4
 223-0034-655 7.4
 223-0034-656 7.4
 223-0035-651 7.4
 223-0035-652 7.4
 223-0035-653 7.4
 223-0035-654 7.4
 223-0035-655 7.4
 223-0035-656 7.4
 223-0036-651 7.4
 223-0036-652 7.4
 223-0036-653 7.4
 223-0036-654 7.4
 223-0036-655 7.4
 223-0036-656 7.4
 223-6296-301 6.3
 223-6296-303 6.3
 223-6296-305 6.4
 223-6296-307 6.4
 223-6296-309 6.4
 223-6296-311 6.4
 223-6316-301 6.3
 223-6316-303 6.3
 223-6316-305 6.4
 223-6316-307 6.4
 223-6316-309 6.4
 223-6316-311 6.4
 223-6346-301 6.3
 223-6346-303 6.3
 223-6346-305 6.4
 223-6346-307 6.4
 223-6346-309 6.4

223-6346-311 6.4
 223-7008-030 3.4
 223-7008-030 5.7
 223-7008-030 8.7
 223-7008-075 3.4
 223-7008-075 5.7
 223-7008-075 8.7
 223-7008-300 7.4
 223-7008-500 7.4

411

411-0001-000 2.3
 411-0021-000 2.3
 411-0031-000 2.3
 411-0036-000 2.4
 411-0041-000 2.3
 411-0041-277 2.4
 411-0046-000 2.4
 411-0051-000 2.3
 411-0051-120 2.3
 411-0051-208 2.3
 411-0051-277 2.4
 411-0056-000 2.4
 411-0061-000 2.3
 411-0066-000 2.4
 411-0071-000 2.3
 411-0071-120 2.3
 411-0071-208 2.3
 411-0071-277 2.4
 411-0077-000 2.4
 411-0081-000 2.3
 411-0087-000 2.4
 411-0091-000 2.3
 411-0091-120 2.3
 411-0091-208 2.3
 411-0091-277 2.4
 411-0097-000 2.4
 411-0101-000 2.3
 411-0101-120 2.3
 411-0101-208 2.3
 411-0101-277 2.4
 411-0104-300 2.3
 411-0107-000 2.4
 411-0111-000 2.3
 411-0111-120 2.3
 411-0111-208 2.3
 411-0111-277 2.4
 411-0114-300 2.3
 411-0117-000 2.4
 411-0131-000 2.3
 411-0131-120 2.3
 411-0131-208 2.3
 411-0131-277 2.4
 411-0134-300 2.3
 411-0137-000 2.4

411-0151-000 2.3
 411-0151-120 2.3
 411-0151-208 2.3
 411-0151-277 2.4
 411-0154-300 2.3
 411-0157-000 2.4
 411-0161-000 2.3
 411-0161-120 2.3
 411-0161-208 2.3
 411-0161-277 2.4
 411-0164-300 2.3
 411-0167-000 2.4
 411-0181-000 2.3
 411-0181-120 2.3
 411-0181-208 2.3
 411-0181-277 2.4
 411-0184-300 2.3
 411-0187-000 2.4
 411-0938-055 11.3
 411-0939-055 11.3
 411-0940-055 11.3
 411-0941-055 11.3

413

413-0018-051 7.4
 413-0018-052 7.4
 413-0018-053 7.4
 413-0018-054 7.4
 413-0018-055 7.4
 413-0018-056 7.4
 413-0019-051 7.4
 413-0019-052 7.4
 413-0019-053 7.4
 413-0019-054 7.4
 413-0019-055 7.4
 413-0019-056 7.4
 413-0020-051 7.4
 413-0020-052 7.4
 413-0020-053 7.4
 413-0020-054 7.4
 413-0020-055 7.4
 413-0020-056 7.4
 413-0021-051 7.4
 413-0021-052 7.4
 413-0021-053 7.4
 413-0021-054 7.4
 413-0021-055 7.4
 413-0021-056 7.4
 413-1101-000 4.3
 413-1102-000 4.3
 413-1103-000 4.3
 413-1104-000 4.3
 413-1105-000 4.4
 413-1107-000 4.3
 413-1108-000 4.3

413-1109-000 4.4
 413-1121-000 4.3
 413-1122-000 4.3
 413-1123-000 4.3
 413-1124-000 4.3
 413-1125-000 4.4
 413-1127-000 4.3
 413-1128-000 4.3
 413-1129-000 4.4
 413-1141-000 4.3
 413-1142-000 4.3
 413-1143-000 4.3
 413-1144-000 4.3
 413-1145-000 4.4
 413-1147-000 4.3
 413-1148-000 4.3
 413-1149-000 4.4

413-1161-000 4.3
 413-1162-000 4.3
 413-1163-000 4.3
 413-1164-000 4.3
 413-1165-000 4.4
 413-1167-000 4.3
 413-1168-000 4.3
 413-1169-000 4.4
 413-1191-000 4.3
 413-1192-000 4.3
 413-1193-000 4.3
 413-1194-000 4.3
 413-1195-000 4.4
 413-1197-000 4.3
 413-1198-000 4.3
 413-1199-000 4.4
 413-1211-000 4.3
 413-1212-000 4.3
 413-1213-000 4.3
 413-1214-000 4.3
 413-1215-000 4.4
 413-1217-000 4.3
 413-1218-000 4.3
 413-1219-000 4.4
 413-1231-000 4.3
 413-1232-000 4.3
 413-1233-000 4.3
 413-1234-000 4.3
 413-1235-000 4.4
 413-1237-000 4.3
 413-1238-000 4.3
 413-1239-000 4.4
 413-110A-000 4.4
 413-112A-000 4.4
 413-114A-000 4.4
 413-116A-000 4.4
 413-119A-000 4.4
 413-121A-000 4.4

13

413-123A-000 4.4

416

416-1100-000 9.8
 416-1101-000 9.8
 416-1111-000 9.8
 416-1121-000 9.8
 416-1131-000 9.8
 416-1141-000 9.8
 416-1151-000 9.8
 416-1161-000 9.8
 416-1171-000 9.8
 416-1181-000 9.8
 416-1191-000 9.8
 416-1201-000 9.8
 416-1211-000 9.8
 416-1221-000 9.8
 416-1231-000 9.8
 416-1241-000 9.8
 416-1251-000 9.8
 416-1261-000 9.8
 416-1271-000 9.8
 416-1281-000 9.8
 416-1291-000 9.8
 416-1401-000 9.8
 416-1411-000 9.8
 416-1421-000 9.8
 416-1431-000 9.8
 416-1441-000 9.8
 416-1451-000 9.8
 416-1461-000 9.8
 416-1471-000 9.8
 416-1481-000 9.8
 416-1491-000 9.8
 416-2101-000 9.8
 416-2111-000 9.8
 416-2201-000 9.8
 416-2211-000 9.8
 416-2401-000 9.8
 416-2411-000 9.8

417

417-0008-PS1 11.4
 417-0008-PS2 11.4
 417-0008-PS3 11.4
 417-0008-TM1 11.4
 417-0008-TM3 11.4
 417-1111-030 11.5
 417-1111-130 11.5
 417-1121-030 11.5
 417-1121-130 11.5
 417-1131-030 11.5
 417-1131-130 11.5

13 Index

Suffix charts on pages **3.4, 4.4, 5.6, and 8.6** will provide the appropriate numbers for ordering units with electrostatic shields, aluminum or copper windings, low temperature rise, and/or K-factor requirements.

417-1141-030 11.5	423-0021-052 7.4	423-6166-301 6.3	423-7215-000 5.5	423-7369-000 5.5
417-1141-130 11.5	423-0021-053 7.4	423-6166-303 6.3	423-7217-000 5.5	423-7391-000 5.4
417-1151-030 11.5	423-0021-054 7.4	423-6166-305 6.4	423-7218-000 5.4	423-7392-000 5.4
417-1151-130 11.5	423-0021-055 7.4	423-6166-307 6.4	423-7219-000 5.5	423-7393-000 5.4
417-1161-030 11.5	423-0021-056 7.4	423-6166-309 6.4	423-7231-000 5.4	423-7394-000 5.5
417-1161-130 11.5	423-0022-051 7.4	423-6166-311 6.4	423-7232-000 5.4	423-7395-000 5.5
		423-0022-052 7.4	423-6196-301 6.3	423-7233-000 5.4	423-7397-000 5.5
		423-0022-053 7.4	423-6196-303 6.3	423-7234-000 5.5	423-7398-000 5.4
		423-0022-054 7.4	423-6196-305 6.4	423-7235-000 5.5	423-7399-000 5.5
		423-0022-055 7.4	423-6196-307 6.4	423-7237-000 5.5	423-716A-000 5.6
		423-0022-056 7.4	423-6196-309 6.4	423-7238-000 5.4	423-719A-000 5.6
		423-0023-051 7.4	423-6196-311 6.4	423-7239-000 5.5	423-721A-000 5.6
		423-0023-052 7.4	423-6216-301 6.3	423-7251-000 5.4	423-723A-000 5.6
		423-0023-053 7.4	423-6216-303 6.3	423-7252-000 5.4	423-725A-000 5.6
		423-0023-054 7.4	423-6216-305 6.4	423-7253-000 5.4	423-726A-000 5.6
		423-0023-055 7.4	423-6216-307 6.4	423-7254-000 5.5	423-729A-000 5.6
		423-0023-056 7.4	423-6216-309 6.4	423-7255-000 5.5	423-731A-000 5.6
		423-0024-051 7.4	423-6216-311 6.4	423-7257-000 5.5	423-734A-000 5.6
		423-0024-052 7.4	423-6236-301 6.3	423-7258-000 5.4	423-736A-000 5.6
		423-0024-053 7.4	423-6236-303 6.3	423-7259-000 5.5	423-739A-000 5.6
		423-0024-054 7.4	423-6236-305 6.4	423-7261-000 5.4		
		423-0024-055 7.4	423-6236-307 6.4	423-7262-000 5.4		
		423-0024-056 7.4	423-6236-309 6.4	423-7263-000 5.4		
		423-0025-051 7.4	423-6236-311 6.4	423-7264-000 5.5	424	
		423-0025-052 7.4	423-6256-301 6.3	423-7265-000 5.5	424-7161-001 8.5
		423-0025-053 7.4	423-6256-303 6.3	423-7266-000 5.5	424-7162-001 8.5
		423-0025-054 7.4	423-6256-305 6.4	423-7267-000 5.5	424-7163-001 8.5
		423-0025-055 7.4	423-6256-307 6.4	423-7268-000 5.4	424-7164-001 8.5
		423-0025-056 7.4	423-6256-309 6.4	423-7269-000 5.5	424-7165-001 8.6
		423-0026-051 7.4	423-6256-311 6.4	423-7291-000 5.4	424-7168-001 8.5
		423-0026-052 7.4	423-6266-301 6.3	423-7292-000 5.4	424-7169-001 8.6
		423-0026-053 7.4	423-6266-303 6.3	423-7293-000 5.4	424-7191-001 8.5
		423-0026-054 7.4	423-6266-305 6.4	423-7294-000 5.5	424-7192-001 8.5
		423-0026-055 7.4	423-6266-307 6.4	423-7295-000 5.5	424-7193-001 8.5
		423-0026-056 7.4	423-6266-309 6.4	423-7297-000 5.5	424-7194-001 8.5
		423-0027-051 7.4	423-6266-311 6.4	423-7298-000 5.4	424-7195-001 8.6
		423-0027-052 7.4	423-7008-045 7.4	423-7299-000 5.5	424-7198-001 8.5
		423-0027-053 7.4	423-7008-075 7.4	423-7311-000 5.4	424-7199-001 8.6
		423-0027-054 7.4	423-7008-150 7.4	423-7312-000 5.4	424-7211-001 8.5
		423-0027-055 7.4	423-7161-000 5.4	423-7313-000 5.4	424-7212-001 8.5
		423-0027-056 7.4	423-7162-000 5.4	423-7314-000 5.5	424-7213-001 8.5
		423-0028-051 7.4	423-7163-000 5.4	423-7315-000 5.5	424-7214-001 8.5
		423-0028-052 7.4	423-7164-000 5.5	423-7317-000 5.5	424-7215-001 8.6
		423-0028-053 7.4	423-7165-000 5.5	423-7318-000 5.4	424-7218-001 8.5
		423-0028-054 7.4	423-7167-000 5.5	423-7319-000 5.5	424-7219-001 8.6
		423-0028-055 7.4	423-7168-000 5.4	423-7341-000 5.4	424-7231-001 8.5
		423-0028-056 7.4	423-7169-000 5.5	423-7342-000 5.4	424-7232-001 8.5
		423-0029-051 7.4	423-7191-000 5.4	423-7343-000 5.4	424-7233-001 8.5
		423-0029-052 7.4	423-7192-000 5.4	423-7344-000 5.5	424-7234-001 8.5
		423-0029-053 7.4	423-7193-000 5.4	423-7345-000 5.5	424-7235-001 8.6
		423-0029-054 7.4	423-7194-000 5.5	423-7347-000 5.5	424-7238-001 8.5
		423-0029-055 7.4	423-7195-000 5.5	423-7348-000 5.4	424-7239-001 8.6
		423-0029-056 7.4	423-7197-000 5.5	423-7349-000 5.5	424-7251-001 8.5
		423-0030-051 7.4	423-7198-000 5.4	423-7361-000 5.4	424-7252-001 8.5
		423-0030-052 7.4	423-7199-000 5.5	423-7362-000 5.4	424-7253-001 8.5
		423-0030-053 7.4	423-7211-000 5.4	423-7363-000 5.4	424-7254-001 8.5
		423-0030-054 7.4	423-7212-000 5.4	423-7364-000 5.5	424-7255-001 8.6
		423-0030-055 7.4	423-7213-000 5.4	423-7365-000 5.5	424-7258-001 8.5
		423-0030-056 7.4	423-7214-000 5.5	423-7366-000 5.5	424-7259-001 8.6
						423-7367-000 5.5	424-7261-001 8.5
						423-7368-000 5.4	424-7262-001 8.5

Version JE901 0809 Date Feb 09



Index

Suffix charts on pages **3.4, 4.4, 5.6, and 8.6** will provide the appropriate numbers for ordering units with electrostatic shields, aluminum or copper windings, low temperature rise, and/or K-factor requirements.

424-7263-0018.5	631-1208-00110.5	631-1810-00110.6
424-7264-0018.5	631-1209-00010.5	631-1811-00010.6
424-7265-0018.6	631-1210-00110.6	631-1901-00010.3
424-7268-0018.5	631-1301-00010.3	631-1902-00010.3
424-7269-0018.6	631-1302-00010.3	631-1903-00010.3
424-7291-0018.5	631-1303-00010.3	631-1904-00010.4
424-7292-0018.5	631-1304-00010.4	631-1905-00010.4
424-7293-0018.5	631-1305-00010.4	631-1906-00010.4
424-7294-0018.5	631-1306-00010.4	631-1908-00110.5
424-7295-0018.6	631-1308-00110.5	631-1909-00010.5
424-7298-0018.5	631-1309-00010.5	631-1910-00110.6
424-7299-0018.6	631-1310-00110.6	631-1911-00010.6
424-7311-0018.5	631-1311-00010.6	631-2001-00010.3
424-7312-0018.5	631-1401-00010.3	631-2002-00110.3
424-7313-0018.5	631-1402-00010.3	631-2003-00110.3
424-7314-0018.5	631-1403-00010.3	631-2004-00010.4
424-7315-0018.6	631-1404-00010.4	631-2005-00010.4
424-7318-0018.5	631-1405-00010.4	631-2006-00010.4
424-7319-0018.6	631-1406-00010.4	631-2008-00110.5
424-7341-0018.5	631-1408-00110.5	631-2010-00110.6
424-7348-0018.5	631-1409-00010.5	631-2011-00010.6
424-7348-0018.5	631-1410-00110.6	631-2101-00010.3
424-7348-0018.6	631-1411-00010.6	631-2106-00010.4
424-7348-0018.6	631-1501-00010.3	631-2107-00010.5
424-7372-0018.5	631-1502-00010.3	631-2112-00110.6
424-7372-0018.5	631-1503-00010.3	631-2113-00110.7
		631-1504-00010.4	631-2201-00010.3
		631-1505-00010.4	631-2206-00010.4
		631-1506-00010.4	631-2207-00010.5
		631-1508-00110.5	631-2212-00110.6
		631-1509-00010.5	631-2213-00110.7
		631-1510-00110.6	631-2301-00010.3
		631-1601-00010.3	631-2306-00010.4
		631-1602-00010.3	631-2307-00010.5
		631-1603-00010.3	631-2312-00110.6
		631-1604-00010.4	631-2313-00110.7
		631-1605-00010.4	631-2401-00110.3
		631-1606-00010.4	631-2406-00110.4
		631-1608-00110.5	631-2407-00110.5
		631-1609-00010.5	631-2412-00110.6
		631-1610-00110.6	631-2413-00110.7
		631-1611-00010.6	631-2601-00110.3
		631-1701-00010.3	631-2606-00110.4
		631-1702-00010.3	631-2607-00110.5
		631-1703-00010.3	631-2612-00110.6
		631-1704-00010.4	631-2613-00110.7
		631-1705-00010.4		
		631-1706-00010.4		
		631-1708-00110.5		
		631-1709-00010.5		
		631-1710-00110.6		
		631-1801-00010.3		
		631-1802-00010.3		
		631-1803-00010.3		
		631-1804-00010.4		
		631-1805-00010.4		
		631-1806-00010.4		
		631-1808-00110.5		
		631-1809-00010.5		

511

511-0078-0552.4
511-0098-0552.4
511-0108-0552.4
511-0118-0552.4
511-0138-0552.4
511-0158-0552.4
511-0168-0552.4
511-0188-0552.4

631

631-0000-00110.7
631-0000-00210.7
631-0000-00410.7
631-0000-00610.7
631-1101-00010.3
631-1102-00010.3
631-1103-00010.3
631-1104-00010.4
631-1105-00010.4
631-1106-00010.4
631-1108-00110.5
631-1109-00010.5
631-1110-00110.6
631-1111-00010.6
631-1201-00010.3
631-1202-00010.3
631-1203-00010.3
631-1204-00010.4
631-1205-00010.4
631-1206-00010.4

Version JE901 0809 Date Feb 09



1-800-892-3755 www.jeffersonelectric.com

Dry-Type Transformers

13.3

13 Index

Warranty Statement

Jefferson Electric, Inc. (Jefferson) warrants to original Purchaser that any products provided by Jefferson hereunder shall be free from defects in material and/or workmanship under normal use and operation; matches functional specifications; and the final product meets industry standards during the warranty period, provided conditions of operation have been normal at all times, and that the product has not been subjected to abnormal stresses, including, but not limited to, such causes as incorrect primary voltage or frequency or improper ventilation. The warranty will not be extended to any product which has been subject to misuse, negligence, accident, improper installation or operation, nor does it extend to any product which has been repaired or altered by any party other than Jefferson.

The warranty provided herein is non-transferable. It is available only for the Purchaser.

Jefferson's liability and the Purchaser's exclusive remedy for claims for defective products, if promptly made in writing to Jefferson within the warranty period, provided such products are returned to the factory, and such claims which are found, after verification by an authorized Jefferson employee, in his or her reasonable judgment, to be defective, shall be limited to repair, replacement or refund of original purchase price, at Jefferson sole and absolute discretion. No products shall be returned to Jefferson without prior written consent. Please contact Jefferson for details of the Return Goods Authorization procedure.

The foregoing is the sole and exclusive warranty of Jefferson. All other warranties written or oral, statutory, expressed or implied, including, without limitation, any implied warranty of merchantability or fitness for any particular purpose, are hereby disclaimed by Jefferson and excluded from the terms of sale.

This Warranty excludes all costs related to removal, installation and proper selection of products. In no event shall Jefferson or its suppliers be liable for any special, indirect, incidental or consequential damages including, but not limited to loss of profit or revenues, loss of use of the products provided or any associated products or equipment, damages to associated products or equipment, cost of capital, cost of substitute products or equipment, facilities downtime costs, labor or associated expenses, or claims of Customers, end users or contractors for such costs.

Warranty Period

Standard catalog transformers:	Ten Years – limited from date of manufacture
Custom quoted products:	One year from date of manufacture
Landscape lighting transformers:	Limited Lifetime warranty for repair or replacement of units in stainless steel enclosures. Ten Years - limited, from date of manufacture on units in painted enclosures.
Products manufactured by third party, including timers, photocells, specialty transformers, and accessories;	See original manufacturers warranty

Version JE901 0809 Date Feb 09

