

SIDES	BOTTOM
Material:Malleable Iron	

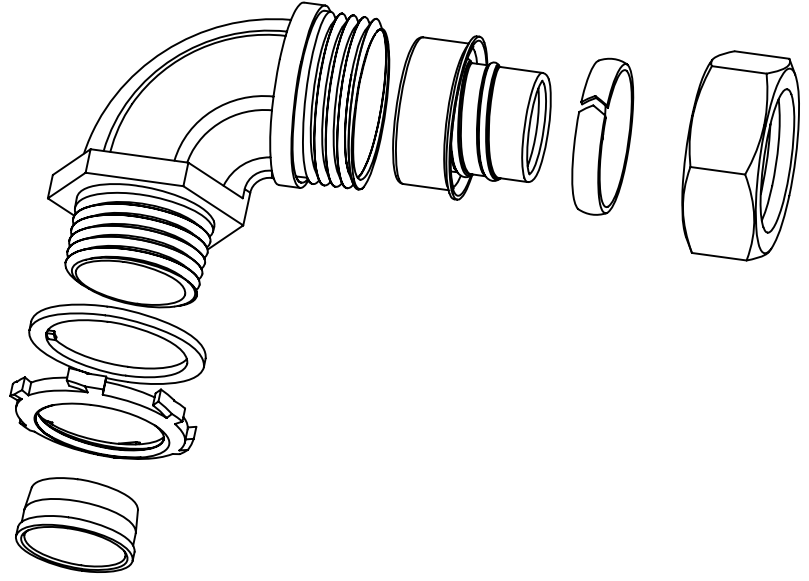
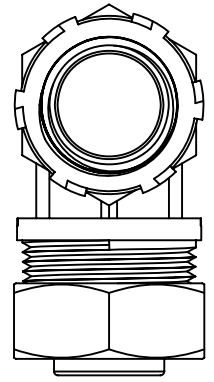
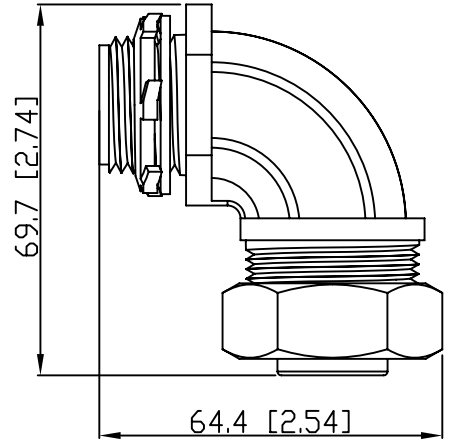
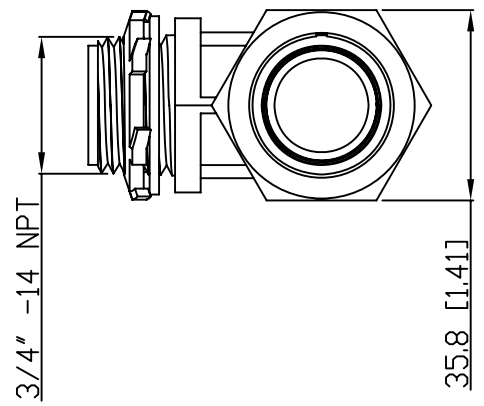

This data sheet is for reference only .GARVIN INDUSTRIES reserv the right to make changes to the design without prior notice.

DESCRIPTION
TRADE REFERENCE TERMS

STANDARD PACKING
10 PCS

GARVIN INDUSTRIES		
TITLE 90° Liquid Tight Conn, 3/4"		
SIZE A4	DWG NO. DS-LTC-7590	REV A