

Sure-Lites

DESCRIPTION

The Sure-Lites Architectural Emergency Light is designed to provide superior illumination while blending into the surrounding space. The housing is constructed of die-cast aluminum with an integral refractive polycarbonate lens and advanced optical design, which in conjunction with energy-efficient, long-lasting LEDs provides maximum path of egress lighting performance. The Sure-Lites Architectural Emergency Light is wet listed for temperatures between -30°C and 50°C (-22°F and 122°F). AEL2 has an always on mode and is available with Eagle Eye self diagnostics.

Catalog #		Type	
Project			
Comments		Date	
Prepared by			

SPECIFICATION FEATURES

Electrical

- Dual Voltage Input, 120/277 VAC, 60Hz
- Line-latching
- Solid-state Voltage Limited Charger
- Low-Voltage Disconnect
- Overload/Short Circuit Protection
- Test Switch/Power Indicator Light
- Fully Recharged in 24 hours
- Self diagnostics

Housing Construction

- Die-cast Aluminum Housing
- Universal Pattern Knockouts on rear of housing for direct mounting to junction box
- 1/2" Threaded Conduit Access on top surface
- Powder Coat Paint Finish
- UV Stable Polycarbonate Lens
- Silicone Gaskets

Code Compliance

- UL924 Listed
- UL Outdoor Wet Location Listed (suitable for wet and damp locations)
- Life Safety NFPA 101
- NEC/OSHA
- Most State and Local Codes
- City of Chicago Code
- New York City Code

Battery

- Sealed Nickel Cadmium
- Maintenance free, long life
- Full Recharge Time, 24 hrs

Warranty

- Unit: 5-Year
- Battery: 7-year pro-rata

Lamp Data

- 10 High Power LEDs
- Two color temperatures: 3000K and 5000K



AEL 2 ARCHITECTURAL EMERGENCY LIGHT SERIES 2

- DIE-CAST ALUMINUM
- SURFACE MOUNT
- SEALED NICKEL CADMIUM BATTERY
- LED LAMPS
- EAGLE EYE SELF DIAGNOSTICS
- ALWAYS ON FEATURE
- EMERGENCY LIGHTING

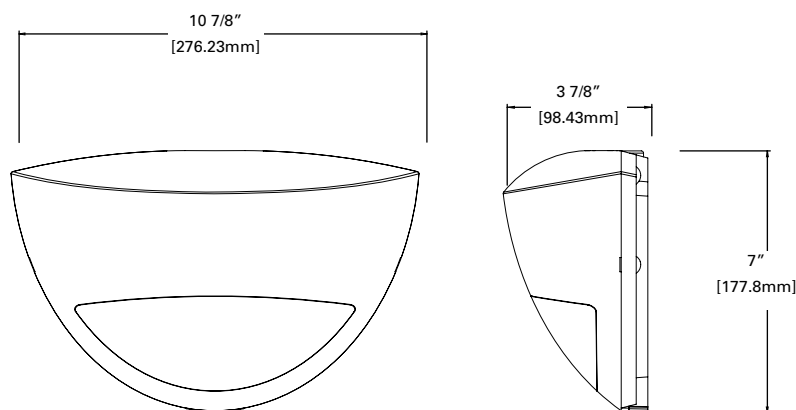

ORDERING INFORMATION

Family AEL2 = Architectural Emergency Light 2	Color Temperature 31 = 3000K Ave 46 = 5000K Ave	Housing Finish ___ = Silver WH = White BK = Black BZ = Bronze	Options ___ = No Self Diagnostics SD = Eagle Eye Self Diagnostics
------------------------------------------------------------	--------------------------------------------------------------	----------------------------------------------------------------------------------	--------------------------------------------------------------------------------

TOTALLY PREDICTABLE
RELIABILITY.

ENERGY DATA

Sealed Nickel Cadmium Battery

Input Current:
(Used as emergency light only):
120V = 2.0 Watts
277V = 2.3 Watts

Input Current:
(Used as dual purpose
emergency light &
always-on light fixture):
120V=5.2 Watts
277V=5.0 Watts

TECHNICAL DATA**Lamps**

The AEL2 utilizes long-lasting LEDs (standard) which provide maximum illumination along the emergency path of egress.

Housing

Die-cast aluminum with a powder coat painted finish. Universal pattern knockouts are located on the back housing for direct mounting to the junction box. Threaded conduit entry provided on the top surface of the housing. UV stable, polycarbonate lens and vacuum-metallized reflector provide efficient optical control.

Electronics

Dual voltage input 120/277 VAC is standard. Nickel cadmium battery is standard. All battery and electrical components are enclosed within the housing.

Line-Latched

Sure-Lites line-latched electronic circuitry makes installation easy and economical. A labor efficient AC activated load switch prevents the lamps from turning on during installation to a non-energized AC circuit. Line-latching eliminates the need for a contractor's return to a job site to connect the batteries when the building's main power is turned on.

Self Diagnostics

The self-diagnostic software will automatically perform all tests required by UL924, and NFPA101. The system indicates the status of the emergency light at all times using the LED indicator. A 90 minute battery power (emergency mode) simulation test will occur once every 12 months. A 30 second battery power simulation test will occur every 30 days.

The Solid-State microprocessor based system has the ability to accurately detect and warn of system failures, plus it incorporates all of the standard electronic features that sets Sure-Lites apart from its competition. Eagle Eye self diagnostic software automatically performs all testing required by the NFPA 101 Life Safety Code and systematically calibrates itself in the field, reducing installation labor and eliminating manual calibration errors.

Solid-State Charger

Supplied with a 120/277 VAC, voltage regulated solid-state charger, the battery is recharged immediately upon restoration of AC current after a power failure. The charge circuit reacts to the condition of the battery in order to maintain peak battery capacity and maximize battery life. Solidstate construction recharges the battery in 24 hours following a power failure in accordance with UL 924.

Solid-State Transfer

The emergency light incorporates solid-state switching which eliminates corroded and pitted contacts or mechanical failures associated with relays. The switching circuit is designed to detect a loss of AC voltage and automatically energizes the lamps using DC power. Upon restoration of AC power, the DC power will be disconnected and the charger will automatically recharge the battery.

Low-Voltage Disconnect

When the battery's terminal voltage falls, the low-voltage circuitry disconnects the lighting load. The disconnect remains in effect until normal utility power is restored, preventing deep battery discharge.

Overload and Short Circuit Protection

The solid-state overload monitoring device in the DC circuit disconnects the lamp load from the battery should excessive wattage demands be made and automatically resets when the overload or short circuit is removed. This overload current protective feature eliminates the need for fuses or circuit breakers for the DC load.

Test Switch/Power Indicator Light

A test switch located on the inside cover of the unit permits the activation of the emergency circuit for a complete operational systems check. The Power Indicator Light provides visual assurance that the AC power is on.

Sealed Nickel Cadmium Battery

Sure-Lites sealed nickel cadmium batteries are maintenance-free with a life expectancy of 15 years. The sealed rechargeable nickel cadmium battery offers high discharge rates and stable performance over a wide range of temperatures. The specially designed resealable vent automatically controls cell pressure, assuring safety and reliability. This battery is best suited for harsh ambient temperatures because the electrolyte is not active in the electrochemical process.

Warranty

The Sure-Lites Architectural Emergency Light is backed by a firm five (5) year warranty against defects in material and workmanship. Maintenance-free, long-life, sealed nickel cadmium batteries carry a seven-year pro-rata warranty.

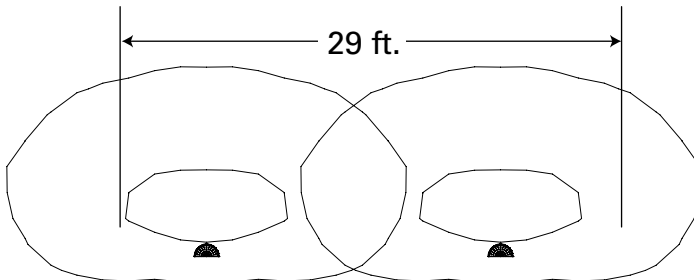
PHOTOMETRICS

SELF DIAGNOSTIC TESTING OPERATIONS

The Sure-Lites Eagle Eye Self Diagnostics is continuously monitoring your emergency fixture and will signal any failure through the 3 color indicator LED.

Initial Operation

When the unit is first powered up, it will go into a 24 hour fast charge, indicated by the indicator LED pulsing green. Once the unit has fully charged, it will perform a self calibration, after which the LED will change to steady green, indicating the unit is fully charged and float charging the battery to maintain readiness.

Automatic Testing

The unit will perform a battery capacity, lamp/LED, and charge circuit test every 30 days for 30 seconds. During this time, the indicator LED will change to a steady yellow. It will perform a full battery capacity (90 minute) test once per year. During this time, the indicator LED will change to a blinking yellow.

Manual Testing

- 10 Second "Installation" test – Press and release the test button once during fast charge (blinking green) to initiate a 10 second quick test. The sign will switch to emergency mode for 10 seconds allowing the installer to verify proper installation of the unit, and the LED indicator will turn solid yellow.
- 30 Second Test - Press and release the test button once during float charge (steady green). The indicator LED will turn steady yellow to indicate the unit is performing a 30 second test of the batteries and lamps/LEDs.
- 90 Minute Test - Press and release the test button a second time during a 30 second test (steady yellow) to change to a 90 minute test. During this test, the LED indicator will change to blinking yellow, and the circuit will perform a full battery capacity, charge circuit, and LED test.
- Canceling Test – Press and release the test button during the 90 minute test (flashing yellow) to return the fixture to its original state (fast charge or float charge)

Laser Test

The LEMSD is equipped with a Laser Test function, that allows the unit to be manually tested without the need to physically press the test button. Shining a laser pointer in the hole marked "LASER TEST" on the bottom of the unit has the same effect as a press and release of the test button.

Clearing Failure Codes









- A battery failure (LED two blink red) can be cleared by replacing the battery. Disconnecting the battery and AC power, or performing a full 90 minute discharge, will reset the error code, however, it will return if the battery is faulty
- Charge Circuit (LED three blink red) and lamp/LED failure (LED four blink red) will clear when the unit successfully passes a manual or automatic 30 second test.

Indicators

- LED Off - No power to unit, emergency mode.
- LED Steady Green - Unit is fully charged and is float charging the battery to maintain readiness.
- LED Green Pulse - Unit is in a 24 hour fast charge of the battery.
- LED Two Blink Red - Battery has failed a capacity test, or the battery is disconnected. See "Clearing Failure Codes" above.
- LED Three Blink Red - Battery charge circuit has failed. See "Clearing Failure Codes" above.
- LED Four Blink Red - Lamps have burned out, or on an EXIT/Combo, 50% or more of the LEDs have failed. See "Clearing Failure Codes" above.
- LED Steady Yellow - 30 second test or 10 second quick test (Fast Charge only).
- LED Blinking Yellow - 90 minute test.

Maintenance

None required. Replace the batteries as needed according to ambient conditions. However, we recommend that the equipment be tested regularly in accordance with local codes.

SURE-LITES			
	OFF - EMERGENCY MODE / POWER OFF		STEADY BLINK YELLOW - 90 MINUTE TEST
	STEADY BLINK GREEN - FAST CHARGE		2 BLINK RED - BATTERY FAILURE
	STEADY GREEN - FULL / FLOAT CHARGE		3 BLINK RED - CHARGE CIRCUIT FAILURE
	STEADY YELLOW - QUICK TEST		4 BLINK RED - LAMP/ LED FAILURE