

UniCode™ Series Factory Sealed Control Stations and Pilot Lights

NEC/CEC:
 Class I, Division 2, Groups B, C, D
 Class I, Zone 2, Group IIC
 Class II, Groups E, F, G
 Class III

NEC/CEC:
 Type 3, 3R, 4, 4X
 IP66

Applications

- For use in hazardous areas as defined by the National Electrical Code (NEC), and Canadian Electrical Code (CEC).
- For use in washdown areas and other damp, wet and highly corrosive areas.
- Push buttons and selector switches are used in conjunction with contactors or magnetic starters for remote control of motors in hazardous locations. They provide circuit control and/or selection.
- Pilot lights provide visual assurance that an electrical function is being performed at a remote or local hazardous location.
- For installation in:
 - Chemical and petrochemical plants
 - Refineries
 - Pulp and paper processing plants
 - Other industrial applications

Features

- Corrosion resistant captive stainless steel screws hold covers to body.
- Available with two types of explosion proof protection. The Labyrinth switch is rated A600 heavy pilot duty and P150.
- Durable materials and construction exceeds UL environmental requirements including impact.
- Enclosures constructed of specially formulated fiberglass reinforced thermoset polyester with low surface resistivity that will not hold a static charge.
- Wide variety of devices and options results in a control station tailor made to the application.
- Pilot light employs LED cluster with lifetime of 100,000 hours that can be used at either 120 Vac or 240 Vac.
- Optional pilot light has 12 Vac/24 Vdc ratings.
- Both the standard hub and union hub provide ground path continuity in feed-thru applications.
- Factory sealed — no external seals required.
- Optional union hub allows temporary rotation of hub for ease of installation.

Standard Materials

- Body and cover: fiberglass reinforced thermoset polyester
- Standard hub, union hub and ground plate: stainless steel and Noryl®
- UCPCB push button and UCSS selector switch operators: polyester, Valox™, and stainless steel
- Screws: stainless steel
- Pilot light: glass jewel

Options

- UCPL Pilot Light is red as standard; if green is desired, add suffix **-JGBG**; if amber is desired, add suffix **-JGBA**; if blue is desired, add suffix **-JGBB**.
- Stainless steel mounting feet available, add suffix **-SSMTG**.
- For Vdc pilot light, add suffix **-DC** to catalog number (push buttons and selector switches have Vac and Vdc ratings as standard).
- Push button front operated mushroom head (maintained contact): standard color is red. Also available in green, add suffix **-NMRBMGR**; and black, add suffix **-NMRBMBL**.
- Push button front operated mushroom head (momentary contact): standard color is black. Also available in red, add suffix **-NMRBRE**; in green, add suffix **-NMRBGR**; or black, add suffix **-NMRBBL**.



1 Device



2 Device



3 Device



4 Device

- Standard momentary push button colors are listed next to catalog numbers for assembled control stations. To change color to red, add suffix **-PBRE**; to change color to green, add suffix **-PBGR**; to change color to black, add suffix **-PBBL**; to change color to yellow, add suffix to **-PBYL**; to change color to blue, add suffix **-PBBU**.
- Three position selector switches with modified operation: Momentary contact right position, spring return to center, maintained contact left position add suffix **-SRC**; Momentary contact left position, spring return to center, maintained contact right position add suffix **-SLC**; Momentary contact left and right positions, spring return to center add suffix **-SRL** (only available on **-345** with ALT option); Alternate contacts add suffix **-ALT**.
- For complete list of options, see Options and Accessories.

NEC/CEC Certifications and Compliances

- UL Standards: UL 508, UL 698, UL 1604, ISA 12.12.01
- CSA Standards: C22.2 No. 25, C22.2 No. 213-M, C22.2 No. 14-M
- cULus Listed: E10449

► Noryl is a registered trademark of General Electric Corp.

UniCode™ Series Factory Sealed Control Stations and Pilot Lights

NEC/CEC:
 Class I, Division 2, Groups B, C, D
 Class I, Zone 2, Group IIC
 Class II, Groups E, F, G
 Class III

NEC/CEC:
 Type 3, 3R, 4, 4X
 IP66

Illustrated Features

Labyrinth Switch Details

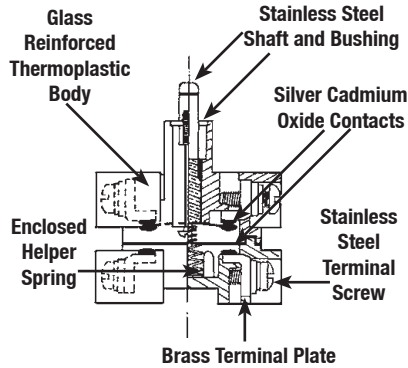

The standard Labyrinth switch is available with universal contacts (1 NO/1 NC). The switch is a UL recognized component and is rated for A600 heavy pilot duty (AC) and P150 (DC) as defined by UL 508. Hazardous Location ratings include Class I, Division 2, Groups B, C, D.

A600 Rating Designation

10 Amp Continuous @ 600 Vac – 7200VA (Make) 720VA (Break)

	Make Amp	Break Amp
120 Vac	60	6
240 Vac	30	3
480 Vac	15	1.5
600 Vac	12	2

P150 Rating Designation

5 Amp Continuous @ 125 Vdc

138VA @ 300 Vdc

1.1 Amp @ 125 Vdc

Hub Details

Two different hubs are available on the UniCode line. Both Versions exceed the UL conduit torque requirements. However, different features are offered by each:

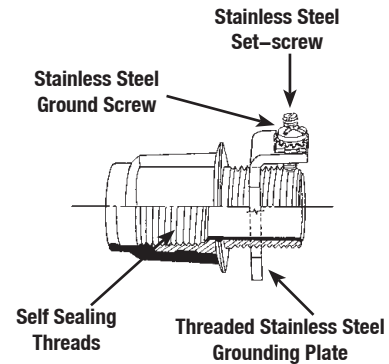

Standard hubs are of stainless steel and Noryl® construction. Stainless steel ground plate is threaded and includes stainless steel set-screw and ground screw.

Stainless Steel/Noryl® Hub

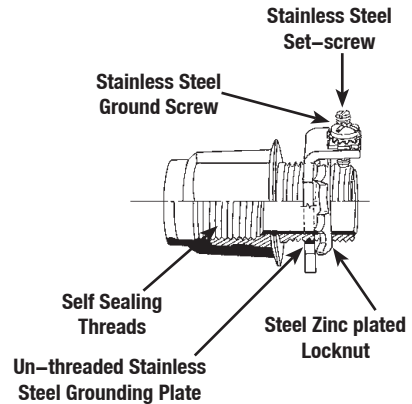

Optional union hubs are of stainless steel and Noryl® construction. Ground plate is stainless steel and not threaded. Hub spins freely for ease of installation; then steel locknut is tightened to secure hub.

► Noryl is a registered trademark of General Electric Corp.

Appleton

CONTROLS: NEC/CEC EXPLOSIONPROOF CONTROL STATIONS AND SWITCHES

UniCode™ Series Factory Sealed Control Stations and Pilot Lights

NEC/CEC:
 Class I, Division 2, Groups B, C, D
 Class I, Zone 2, Group IIC
 Class II, Groups E, F, G
 Class III

NEC/CEC:
 Type 3, 3R, 4, 4X
 IP66

Catalog Numbering Guide

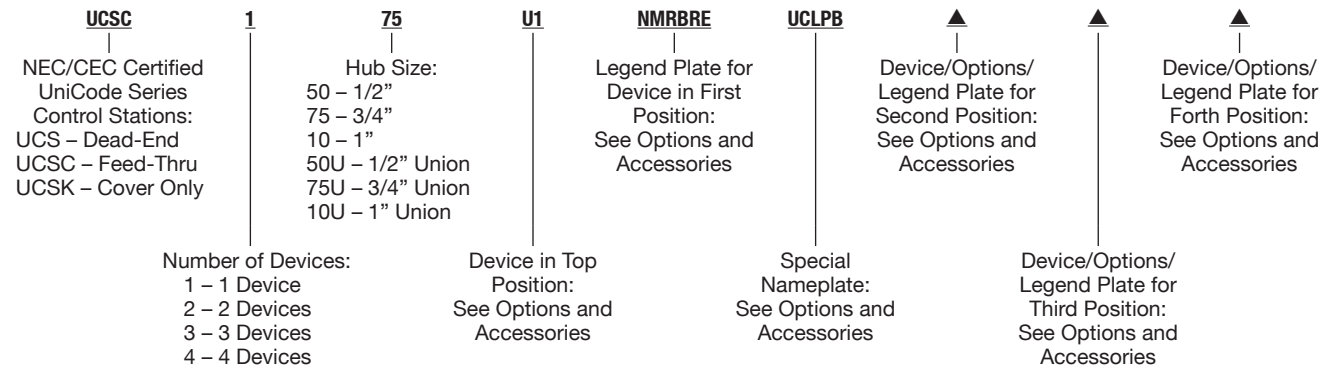

Device Descriptions	Device Code
Momentary Push Button - 1NO/NC	U1 ①
Momentary Push Button - 2NO/NC	UD1
Maintained Push Button - 1NO/NC	UM1
Maintained Push Button - 2NO/NC	UDM1
Pilot Light	J1 ②
2-POS 2-CKT Selector Switch	12
3-POS 2-CKT Selector Switch	102
2-POS 4-CKT Selector Switch	35
3-POS 4-CKT Selector Switch (Labyrinth Switch Only)	345
Close-up Plug	PLG
Options Descriptions	Device Code
Amber Pilot Light	JGBA
Green Pilot Light	JGBG
Blue Pilot Light	JGBB
DC Rating for Pilot Light	DC
Red Mushroom Head - Momentary Push Button	NMRBRE
Green Mushroom Head - Momentary Push Button	NMRBGR
Black Mushroom Head - Momentary Push Button	NMRBBL
Black Mushroom Head - Maintained Push Button	NMRBMBL
Green Mushroom Head - Maintained Push Button	NMRBMGR
Spring Return from Right - Selector Switch (3 Position Only)	SRC
Spring Return from Left - Selector Switch (3 Position Only)	SLC
Spring Return from Right and Left - Selector Switch (3 Pos, 4 Ckt and Alt Contacts Only)	SRL
Alternate Contacts - Selector Switch	ALT
Red Momentary Push Button	PBRE
Green Momentary Push Button	PBGR
Accessories Descriptions	Accessory Code
Stainless Steel Mounting Feet	SSMTG
Mushroom Head Push Button Locking Guard	UCMPBLG

① Momentary push buttons are black. Add —**PBRE** for red or —**PBGR** for green.
 ② Pilot lights are red. Add —**JGBA** for amber, —**JGBG** for green or —**JGBB** for blue.

Appleton
 CONTROLS: NEC/CEC EXPLOSIONPROOF CONTROL STATIONS AND SWITCHES

UniCode™ Series Factory Sealed Control Stations and Pilot Lights

NEC/CEC:
Class I, Division 2, Groups B, C, D
Class I, Zone 2, Group IIC
Class II, Groups E, F, G
Class III

NEC/CEC:
Type 3, 3R, 4, 4X
IP66

		Hub Size (Inches)	Description	Diagram	Standard Legend Plate Marking and Device Color	Catalog Number	
						Dead-End	Feed-Thru
Push Buttons							
Momentary Contact							
	1/2					UCS150U1	UCSC150U1
	3/4	1 Circuit Universal		Start/Green	UCS175U1	UCSC175U1	
	1				UCS110U1	UCSC110U1	
	1/2					UCS250U2	UCSC250U2
	3/4	2 Circuits Universal		Start/Green Stop/Red	UCS275U2	UCSC275U2	
	1				UCS210U2	UCSC210U2	
	1/2					UCS350U3	UCSC350U3
	3/4	3 Circuits Universal		Blank/Black	UCS375U3	UCSC375U3	
	1				UCS310U3	UCSC310U3	
	1/2					UCS450U4	UCSC450U4
	3/4	4 Circuits Universal		Blank/Black	UCS475U4	UCSC475U4	
	1				UCS410U4	UCSC410U4	
Maintained Contact							
	1/2					UCS150UM1	UCSC150UM1
	3/4	1 Circuit Universal		Emergency Stop/Red	UCS175UM1	UCSC175UM1	
	1				UCS110UM1	UCSC110UM1	
Pilot Lights							
Pilot Light has terminals for 120 or 240 Vac – Uses 8 cluster LED							
	1/2					UCS150J1	UCSC150J1
	3/4	1 Pilot Light		Blank/Red	UCS175J1	UCSC175J1	
	1				UCS110J1	UCSC110J1	
	1/2					UCS250J2	UCSC250J2
	3/4	2 Pilot Lights		Blank/Red	UCS275J2	UCSC275J2	
	1				UCS210J2	UCSC210J2	
	1/2					UCS350J3	UCSC350J3
	3/4	3 Pilot Lights		Blank/Red	UCS375J3	UCSC375J3	
	1				UCS310J3	UCSC310J3	
	1/2					UCS450J4	UCSC450J4
	3/4	4 Pilot Lights		Blank/Red	UCS475J4	UCSC475J4	
	1				UCS410J4	UCSC410J4	

Appleton

CONTROLS: NEC/CEC EXPLOSIONPROOF CONTROL STATIONS AND SWITCHES

UniCode™ Series Factory Sealed Control Stations and Pilot Lights

NEC/CEC:
Class I, Division 2, Groups B, C, D
Class I, Zone 2, Group IIC
Class II, Groups E, F, G
Class III

NEC/CEC:
Type 3, 3R, 4, 4X
IP66

Hub Size (Inches)	Description	Diagram			Standard Legend Plate Marking and Device Color	Catalog Number	
		Left	Center	Right		Dead-End	Feed-Thru
Selector Switches							
1/2	2 Positions, 2 Circuits		None		On/Off	UCS15012	UCSC15012
3/4						UCS17512	UCSC17512
1						UCS11012	UCSC11012
1/2	2 Positions, 4 Circuits		None		On/Off	UCS15035	UCSC15035
3/4						UCS17535	UCSC17535
1						UCS11035	UCSC11035
1/2	3 Positions, 2 Circuits				Hand/Off/Auto	UCS150102	UCSC150102
3/4						UCS175102	UCSC175102
1						UCS110102	UCSC110102
1/2	3 Positions, 4 Circuits				Hand/Off/Auto	UCS150345	UCSC150345
3/4						UCS175345	UCSC175345
1						UCS110345	UCSC110345
1/2	3 Positions, 4 Circuits, Alternate Contacts				Hand/Off/Auto	UCS150345ALT	UCSC150345ALT
3/4						UCS175345ALT	UCSC175345ALT
1						UCS110345ALT	UCSC110345ALT
Pilot Lights and Push Buttons							
1/2	1 Circuit Universal and 1 Pilot Light				Pilots: Blank/Red; Push Button: Start/Green	UCS250J1U1	UCSC250J1U1
3/4						UCS275J1U1	UCSC275J1U1
1						UCS210J1U1	UCSC210J1U1
1/2	1 Circuit Universal and 2 Pilot Lights				Pilots: Blank/Red; Push Button: Start/Green	UCS350J2U1	UCSC350J2U1
3/4						UCS375J2U1	UCSC375J2U1
1						UCS310J2U1	UCSC310J2U1
1/2	2 Circuits Universal and 1 Pilot Light				Pilot: Blank/Red; Push Button: Start/Green, Stop/Red	UCS350J1U2	UCSC350J1U2
3/4						UCS375J1U2	UCSC375J1U2
1						UCS310J1U2	UCSC310J1U2
1/2	2 Circuits Universal and 2 Pilot Lights				Pilot: Blank/Red; Push Button: Start/Green, Stop/Red	UCS450J2U2	UCSC450J2U2
3/4						UCS475J2U2	UCSC475J2U2
1						UCS410J2U2	UCSC410J2U2
Pilot Lights, Push Buttons and Selector Switches							
1/2	1 Circuit Universal, 1 Pilot Light and 1 Selector Switch			None	Pilot: Blank/Red; Push Button: Blank/Black; Sel. Switch: On/Off	UCS350J1U112	UCSC350J1U112
3/4						UCS375J1U112	UCSC375J1U112
1						UCS310J1U112	UCSC310J1U112
1/2	1 Circuit Universal, 1 Pilot Light and 1 Selector Switch				Pilot: Blank/Red; Push Button: Blank/Black; Sel. Switch: Hand/On/Off	UCS350J1U1102	UCSC350J1U1102
3/4						UCS375J1U1102	UCSC375J1U1102
1						UCS310J1U1102	UCSC310J1U1102

Appleton

CONTROLS: NEC/CEC EXPLOSIONPROOF CONTROL STATIONS AND SWITCHES

UniCode™ Series Factory Sealed Control Stations and Pilot Lights

Mounting Bodies Covers and Replacement Hubs

NEC/CEC:
 Class I, Division 2, Groups B, C, D
 Class I, Zone 2, Group IIC
 Class II, Groups E, F, G
 Class III

NEC/CEC:
 Type 3, 3R, 4, 4X
 IP66

Covers Only

Covers sold separately are marked Class I, Division 2, Groups B, C, D; Class I, Zone 2, Group IIC; NEMA 3, 3R, 4, 4X only.



Description	Catalog Number
1 Device	UCC1
2 Device	UCC2
3 Device	UCC3
4 Device	UCC4

Replacement Hubs — For use with Threaded Metal Conduit

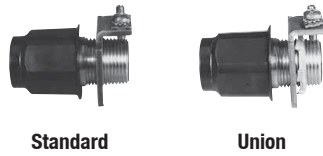

Hub Size (Inches)	Catalog Number	
	Standard Hub	Union Hub
1/2	UCHUB50	UCHUB50U
3/4	UCHUB75	UCHUB75U
1	UCHUB10	UCHUB10U

Mounting Bodies

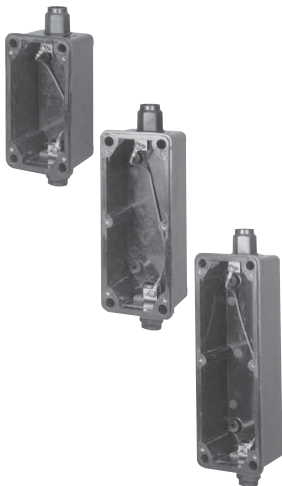

Description	Hub Size (Inches)	Standard Hub		Union Hub	
		Dead-End	Feed-Thru	Dead-End	Feed-Thru
1 Device or 2 Device	1/2	UCBB250	UCBBC250	UCBB250U	UCBBC250U
	3/4	UCBB275	UCBBC275	UCBB275U	UCBBC275U
	1	UCBB210	UCBBC210	UCBB210U	UCBBC210U
3 Device	1/2	UCBB350	UCBBC350	UCBB350U	UCBBC350U
	3/4	UCBB375	UCBBC375	UCBB375U	UCBBC375U
	1	UCBB310	UCBBC310	UCBB310U	UCBBC310U
4 Device	1/2	UCBB450	UCBBC450	UCBB450U	UCBBC450U
	3/4	UCBB475	UCBBC475	UCBB475U	UCBBC475U
	1	UCBB410	UCBBC410	UCBB410U	UCBBC410U

Appleton®

CONTROLS: NEC/CEC EXPLOSIONPROOF CONTROL STATIONS AND SWITCHES















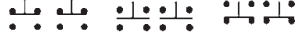

UniCode™ Series Factory Sealed Control Stations and Pilot Lights

Selector Switches. Component Parts

NEC/CEC:

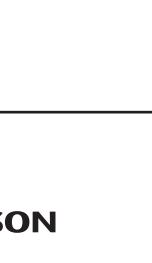
Class I, Division 2, Groups B, C, D
 Class I, Zone 2, Group IIC
 Class II, Groups E, F, G
 Class III



Selector Switch

	Description	Diagram	Catalog Number
 <p>2 Position, 2 Circuit</p>	2 Position, 2 Circuit, Maintain Contact Left Position, Maintain Contact Right Position On/Off nameplate		UCSS12
	2 Position, 4 Circuit, Maintain Contact Left Position, Maintain Contact Right Position On/Off nameplate		UCSS22
 <p>2 Position, 4 Circuit</p>	3 Position, 2 Circuit, Maintain Contact Left Position, Maintain Contact Right Position Hand-Off-Auto nameplate		UCSS13
	3 Position, 2 Circuit, Momentary Contact Right Position, Spring Return to Center, Maintain Contact Left Position		UCSS13SRC
 <p>3 Position, 2 Circuit</p>	3 Position, 2 Circuit, Momentary Contact Left Position, Spring Return to Center, Maintain Contact Right Position		UCSS13SLC
	3 Position, 4 Circuit Maintain Contact Left Position Maintain Contact Right Position		UCSS23
 <p>3 Position, 2 Circuit</p>	3 Position, 4 Circuit, Alternate Contacts Maintain Contact Left Position Maintain Contact Right Position		UCSSA23
	3 Position, 4 Circuit Momentary Contact Right Position Spring Return to Center Maintain Contact Left Position		UCSS23SRC
 <p>3 Position, 4 Circuit</p>	3 Position, 4 Circuit, Alternate Contacts, Momentary Contact Right Position, Spring Return to Center, Maintain Contact Left Position		UCSSA23SRC
	3 Position, 4 Circuit, Momentary Contact Left Position, Spring Return to Center, Maintain Contact Right Position		UCSS23SLC
	3 Position, 4 Circuit, Alternate Contacts, Momentary Contact Left Position; Spring Return to Center, Maintain Contact Right Position		UCSSA23SLC
	3 Position, 4 Circuit, Alternate Contacts, Momentary Contact Left Position, Spring Return to Center, Momentary Contact Right Position		UCSSA23SRL

UniCode™ Series Factory Sealed Control Stations and Pilot Lights

Component Parts

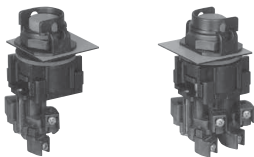
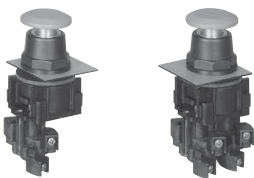
NEC/CEC:
 Class I, Division 2, Groups B, C, D
 Class I, Zone 2, Group IIC
 Class II, Groups E, F, G
 Class III

	Description	Catalog Number
Assembled Push Buttons		
	Momentary Black - One Labyrinth Switch	UCPB1BL
	Momentary Black - Two Labyrinth Switches	UCPB2BL
	Momentary Red - One Labyrinth Switch	UCPB1RE
	Momentary Red - Two Labyrinth Switches	UCPB2RE
	Momentary Green - One Labyrinth Switch	UCPB1GR
	Momentary Green - Two Labyrinth Switches	UCPB2GR
	Momentary Yellow - One Labyrinth Switch	UCPB1YL
	Momentary Yellow - Two Labyrinth Switches	UCPB2YL
	Momentary Blue - One Labyrinth Switch	UCPB1BU
	Momentary Blue - Two Labyrinth Switches	UCPB2BU
	Maintained Black - One Labyrinth Switch	UCPBM1BL
	Maintained Black - Two Labyrinth Switches	UCPBM2BL
	Maintained Red - One Labyrinth Switch	UCPBM1RE
	Maintained Red - Two Labyrinth Switches	UCPBM2RE
	Maintained Green - One Labyrinth Switch	UCPBM1GR
	Maintained Green - Two Labyrinth Switches	UCPBM2GR
Sub Components For Push Buttons		
	Green Momentary Mushroom Head	UCMHGR
	Red Momentary Mushroom Head	UCMHRE
	Black Momentary Mushroom Head	UCMHBL
	Green Maintained Mushroom Head	UCMHMGR
	Red Maintained Mushroom Head	UCMHMRE
	Black Maintained Mushroom Head	UCMHMBL
	Green Cap for Momentary Push button	UCPBCAPGR
	Red Cap for Momentary Push button	UCPBCAPRE
	Black Cap for Momentary Push button	UCPBCAPBL
	Yellow Cap for Momentary Push button	UCPBCAPYL
Blue Cap for Momentary Push button	UCPBCAPBU	
Pilot Lights		
	Red LED Pilot Light (120/240 Vac)	UCPLR
	Green LED Pilot Light (120/240 Vac)	UCPLG
	Amber LED Pilot Light (120/240 Vac)	UCPLA
	Blue LED Pilot Light (120/240 Vac)	UCPLB
	Red LED Pilot Light (12/24 Vdc)	UCPLRDC
	Green LED Pilot Light (12/24 Vdc)	UCPLGDC
	Amber LED Pilot Light (12/24 Vdc)	UCPLADC
	Blue LED Pilot Light (12/24 Vdc)	UCPLBDC

 **Appleton**

CONTROLS: NEC/CEC EXPLOSIONPROOF CONTROL STATIONS AND SWITCHES

UniCode™ Series Factory Sealed Control Stations and Pilot Lights

Component Parts

NEC/CEC:
 Class I, Division 2, Groups B, C, D
 Class I, Zone 2, Group IIC
 Class II, Groups E, F, G
 Class III

Actuators Without Contact Blocks



Selector Switch



Momentary Push Button



Maintained Mushroom Head Push Button

Description	Catalog Number For LAB1
2 Position Selector Switch	UCSS2
3 Position Selector Switch	UCSS3
3 Position Selector Switch - Spring Return From Right	UCSS3SRC
3 Position Selector Switch - Spring Return From Left	UCSS3SLC
3 Position Selector Switch - Alternate Contacts	UCSSA3
3 Position Selector Switch - Alternate Contacts Spring, Return From Right	UCSSA3SRC
3 Position Selector Switch - Alternate Contacts Spring, Return From Left	UCSSA3SLC
3 Position Selector Switch - Alternate Contacts Spring, Return From Right and Left	UCSSA3SRL
For LAB1 Switch	Catalog Number
Momentary Push button - Black	UCPBBL
Momentary Push button - Red	UCPBRE
Momentary Push button - Green	UCPBGR
Momentary Push button - Blue	UCPBBLU
Momentary Push button - Yellow	UCPBYL
Maintained Mushroom Head - Black	UCPBMBL
Maintained Mushroom Head - Red	UCPBMR
Maintained Mushroom Head - Green	UCPBMRG
Momentary Mushroom Head - Black	UCPBMYBL
Momentary Mushroom Head - Red	UCPBMYRE
Momentary Mushroom Head - Green	UCPBMYGR

Contact Block

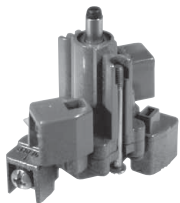

Labyrinth Switch

Labyrinth Switch – Universal (1 NO, 1 NC)

LAB1

The Standard labyrinth switch is available with universal contacts (1 NO/1 NC). The switch is a UL recognized component and is rated for A600 heavy pilot duty (Vac) and P150 (Vdc) as defined by UL 508. Hazardous location ratings include Class I, Division 2, Groups B, C, D.

A600 Rating Designation	Vac	Make Amp	Break Amp	P150 Rating Designation
10 Amp Continuous @ 600 Vac	120	60	6	5 Amp Continuous @125 Vdc
7200VA (Make) 720VA (Break)	240	30	3	138VA @ 300 Vdc
	480	15	1.5	1.1 Amp @ 125 Vdc
	600	12	2	

Accessories



Description	Catalog Number
Close-Up Plug	UCPLUG
Momentary Push Button Locking Guard (Included as standard with push button)	UCLG1
Maintained Mushroom Head Push Button Locking Guard ① (Locks Button in Down Position)	UCMPBLG
2 Stainless Steel Mounting Feet	SSMTG

① Requires a padlock with 6 mm (0.25") hasp.

UniCode™ Series Factory Sealed Control Stations and Pilot Lights

Component Parts

NEC/CEC:
 Class I, Division 2, Groups B, C, D
 Class I, Zone 2, Group IIC
 Class II, Groups E, F, G
 Class III

Legend Plates

Gray With Black Letters	Green With White Letters	Red With White Letters
For Push button and Selector Switches	For Push button and Selector Switches	For Push button and Selector Switches
UCLP - _____ (Add Desired Marking) ①	UCLPG - _____ (Add Desired Marking) ①	UCPLR - _____ (Add Desired Marking) ①
For Pilot Lights	For Pilot Lights	For Pilot Lights
UCPLP - _____ (Add Desired Marking) ①	UCPLPG - _____ (Add Desired Marking) ①	UCPLPR - _____ (Add Desired Marking) ①

Standard Legend Plates

Description	Catalog Number	Description	Catalog Number
Two Position Selector Switch			
Forward—Reverse	UCLP-FR	Run—Jog	UCLP-RG
Hand—Auto	UCLP-HA	Off—Remote	UCLP-OR
On—Off	UCLP-OO	Auto—Hand	UCLP-AH
Start—Stop	UCLP-SS	Auto—Off	UCLP-AO
Local—Remote	UCLP-LR	Blank	UCLP-B
Up—Down	UCLP-UD		
Three Position Selector Switch			
Reverse—Off—Forward	UCLP-ROF	Hand—Off—Remote	UCLP-HOR
Forward—Off—Reverse	UCLP-FOR	Local—Off—Remote	UCLP-LOR
Hand—Off—Auto	UCLP-HOA	Remote—Off—Local	UCLP-ROL
Auto—Off—Hand	UCLP-AOH	Auto—Off—Manual	UCLP-AOM
Job—Off—Run	UCLP-JOR	Open—Off—Close	UCLP-OOC
Run—Off—Jog	UCLP-ROJ	Test—Off—On	UCLP-TOO
Off—Run—Start	UCLP-ORS	1—Off—2	UCLP-1O2
Stop—Run—Start	UCLP-SRS	Blank	UCLP-B
Push Buttons (Standard, Momentary and Maintained Mushroom Heads)			
Blank	UCLP-B	Fast	UCLP-FAST
Off	UCLP-OFF	Slow	UCLP-SLOW
On	UCLP-ON	Raise	UCLP-RAISE
Forward	UCLP-FWD	Lower	UCLP-LOWER
Reverse	UCLP-REV	Open	UCLP-OPEN
Jog	UCLP-JOG	Close	UCLP-CLOSE
Run	UCLP-RUN	Low	UCLP-LOW
Start	UCLP-ST	High	UCLP-HIGH
Stop	UCLP-SP	Test	UCLP-TEST
Up	UCLP-UP	Reset	UCLP-RESET
Down	UCLP-DOWN		
Pilot Lights			
Blank	UCPLP-B	On	UCPLP-ON
Run	UCPLP-RUN	Off	UCPLP-OFF



① Standard legend plate markings listed above.

UniCode™ Series Factory Sealed Control Stations and Pilot Lights

NEC/CEC:
 Class I, Division 2, Groups B, C, D
 Class I, Zone 2, Group IIC
 Class II, Groups E, F, G
 Class III

NEC/CEC:
 Type 3, 3R, 4, 4X
 IP66

Dimensions in Millimeters (Inches)

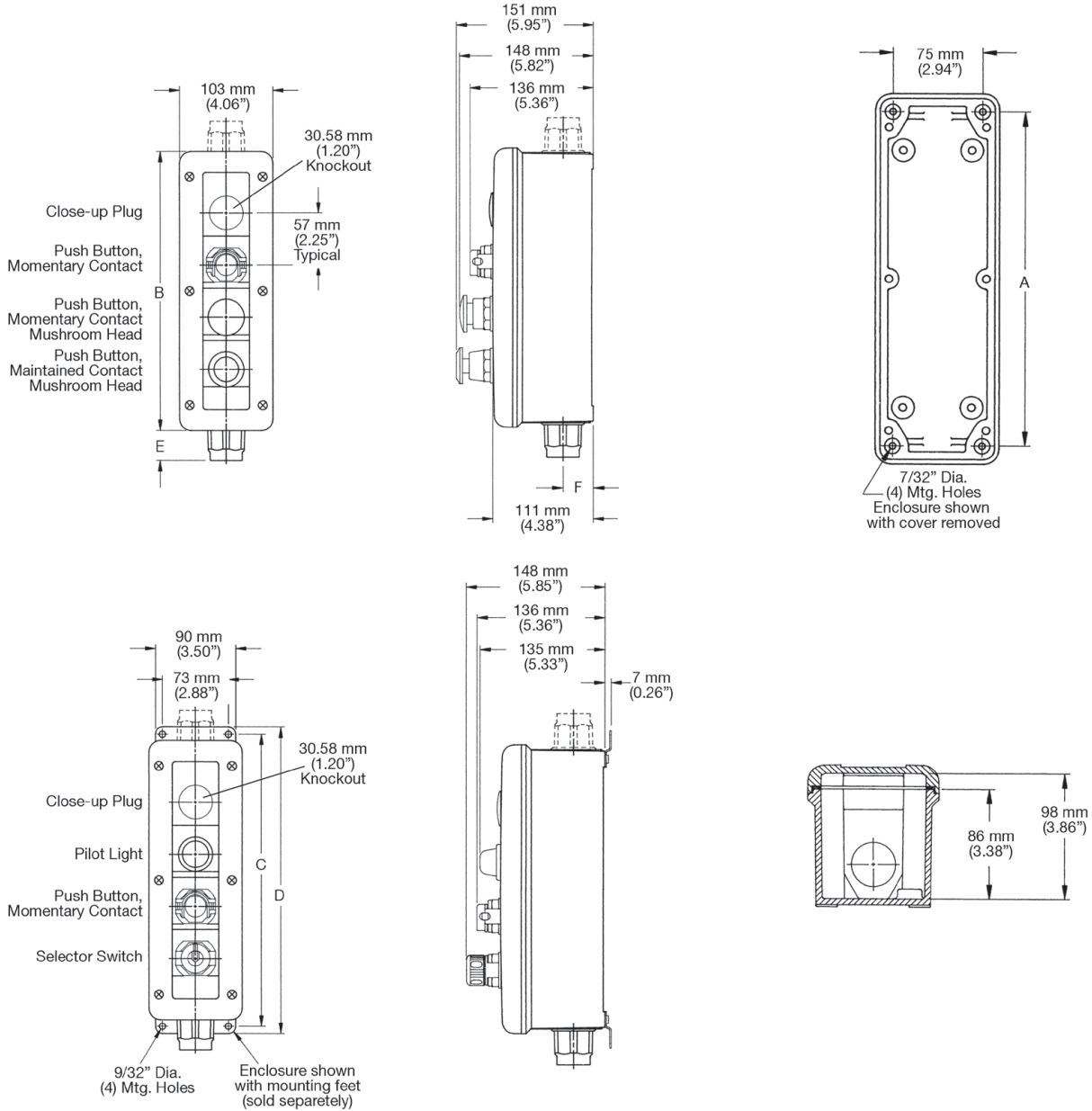

CONTROLS: NEC/CEC EXPLOSIONPROOF CONTROL STATIONS AND SWITCHES

Appleton

Enclosures	Hub Size (Inches)	Dimensions in Millimeters (Inches)					
		A	B	C	D	E	F
1 or 2 Device	1/2	162.1 (6.38)	192.0 (7.56)	206.5 (8.13)	222.8 (8.77)	31.2 (1.23)	26.9 (1.06)
3-Device	3/4	219.2 (8.63)	249.2 (9.81)	263.7 (10.38)	279.9 (11.02)	31.8 (1.25)	26.9 (1.06)
4 Device	1	276.4 (10.88)	306.3 (12.06)	320.8 (12.63)	337.1 (13.27)	32.5 (1.28)	33.3 (1.31)