

A.T.X.[®] PRE Series 16 Amp Plugs and Sockets

Increased Safety

Zone 1 and 2 - 21 and 22
 Ⓢ II 2 GD
 ATEX / IECEx
 IP66 - IK09/10

Applications

- Plugs and receptacles are used with portable or stationery electrical equipment such as:
 - Lighting systems
 - Conveyors
 - Heaters
 - Motor generators
 - Air conditioning equipment
 - Compressors
 - Pumps
- For use in corrosive atmospheres and installations in Zone 1 and 2 and 21 and 22 of the oil and gas industry; such as:
 - Refineries
 - Chemical and petrochemical plants
 - Pipelines
 - Loading docks
 - Onshore and offshore drilling platforms

Features

- Plug and socket system is designed with a safe disconnect mechanism to insure maximum hazardous location protection:
 - The contact separation is in a flameproof chamber
 - The automatic electrical disconnection of each phase is contained in a second flameproof chamber
- Short circuit protection is 20 kA, while normal reference is 10 kA.
- Different voltages are color coded for easy identification.
- The receptacles are keyed to accept only ATX plugs (other plugs can not be inserted).
- ATX plugs can be used in non-hazardous IEC 309 sockets.
- Operating temperature of -40 °F/-40 °C to +131 °F/+55 °C

Standard Materials

- Wall Socket for 2P - 2P+E - 3P: high impact resistance polycarbonate
- Wall Socket for 3P+E - 3P+N+E: high impact resistance fiberglass reinforced polyester
- Plug, mobile socket and flush socket: polyamide

Certifications and Compliances

- Certification Type PCX, PCX/EN
- Gas: Zones 1 and 2
 - Conforming to ATEX 94/9/CE: CE 0081 Ⓢ II 2 G
 - ATEX/IEC Protection: Ex de IIC
 - T6 for $T_a \leq +104 \text{ °C}/+40 \text{ °C}$ and T5 for $T_a \leq +131 \text{ °F}/+55 \text{ °C}$
 - Ambient Temperature: $-40 \text{ °F}/-40 \text{ °C} \leq T_a \leq +131 \text{ °F}/+55 \text{ °C}$
- Dust: Zones 21 and 22
 - Conforming to ATEX 94/9/CE: CE 0081 Ⓢ II 2 D
 - ATEX/IEC Protection: Ex tD A21
 - Surface Temperature: T154 °F/68 °C
 - Ambient Temperature: $-40 \text{ °F}/-40 \text{ °C} \leq T_a \leq +131 \text{ °F}/+55 \text{ °C}$
- CE Declaration of Conformity: 50228, 5C214
- ATEX Certificate: LCIE 02 ATEX 6068, LCIE 02 ATEX 0001U
- IECEx Certificate: IECEx LCI 04.0014, IECEx LCI 04.0012
- Other Certifications: GOST
- Ingress Protection (solid and liquid): IP66
- Impact Resistance (shock): IK10 (Polyester) and IK09 (Polyamide)
- Ex Standards: EN/IEC 60079-0; 60079-1, 60079-7; 61241-0, 61241-1
- Product Standards: EN/IEC 60309-1, 60309-2
- Other Standards: EN/IEC 60529 (IP), 62262 (IK)



Technical Data

Breaking Capacity	
AC 3	4 kW – 220 V
	4.3 kW – 240 V
	7.5 kW – 380 V
	8.2 kW – 415 V
ICC	20 kA

Plugs and Receptacles

PLUGS AND RECEPTACLES: HAZARDOUS LOCATION

A.T.X.[®] PRE Series 16 Amp Plugs and Sockets

Increased Safety

Zone 1 and 2 - 21 and 22
 II 2 GD
 ATEX / IECEx
 IP66 - IK09/10



Wall Mounting Socket

- Three M20 threaded entries (one on the top and two on the bottom).
- Supplied with one M20 cable gland (Ø 0.26 to Ø 0.57" / Ø 6.5 to Ø 14.5 mm) and two M20 blanking plugs.
- Terminal capacity 0.003 x 0.006 in² / 2 x 4 mm². Can be through-wired.
- Fitted with three linked earth terminals.



Plug

- One PG16 integrated cable gland (Ø 0.26 to Ø 0.57" / Ø 6.5 to Ø 14.5 mm).
- Terminal capacity 0.004 in² / 2.5 mm².



Mobile Socket

- One PG16 integrated cable gland (Ø 0.26 to Ø 0.57" / Ø 6.5 to Ø 14.5 mm).
- Terminal capacity 0.003 x 0.006 in² / 2 x 4 mm².



Flush Socket

- Terminal capacity 0.003 x 0.006 in² / 2 x 4 mm².

Plugs and Receptacles

PLUGS AND RECEPTACLES: HAZARDOUS LOCATION

Catalog Numbering Guide

PRE
 Series:
 PRE - PRE Series
 Zone 1, 2, 21 and 22
 ATEX / IEC

2
 Pin Configuration:
 2 - 2P
 3 - 2P+E
 4 - 3P+E
 5 - 3P+N+E
 6 - 3P

16
 Amps:
 16 - 16A

R
 Equipment:
 P - Plug
 R - Receptacle
 (Wall Mounting)
 M - Mobile Socket
 F - Flush Socket

P
 Voltage:
 P - 20 - 25 Vac
 50/60 Hz
 W1 - 20 - 50 Vdc
 W - 40 - 50 Vac
 50/60 Hz
 Y - 100 - 130 Vac
 50/60 Hz
 B - 200 - 250 Vac
 50/60 Hz
 R - 380 - 415 Vac
 50/60 Hz
 N - 480 - 500 Vac
 50/60 Hz
 G - 50 - 500 Vac 300
 to 500 Hz

ELV: Extra Low Voltage

Purple	White	White
20/25 Vac	20/50 Vdc	40/50 Vac

















LV: Low Voltage

Yellow	Blue	Red	Black	Green
100/130 Vac	200/250 Vac	380/415 Vac	480/500 Vac	50/500 Vac (300 to 500 Hz)

A.T.X.[®] PRE Series 16 Amp Extra Low Voltage and Low Voltage Plugs and Sockets

Increased Safety

Zone 1 and 2 - 21 and 22
 II 2 GD
 ATEX / IECEx
 IP66 - IK09/10

Description	Pin Configuration	Weight (lb/kg)	Volume (in ³ /dm ³)	Catalog Number
Extra Low Voltage: ELV				
20/25 Vac 50/60 Hz — Purple				
Wall Socket		1.3/0.6	231.89/3.8	PRE216RP
Plug		0.4/0.2	361.6/0.6	PRE216PP
Mobile Socket		0.9/0.4	79.33/1.3	PRE216MP
Flush Socket		0.4/0.2	79.33/1.3	PRE216FP
Wall Socket		1.3/0.6	231.89/3.8	PRE316RP
Plug		0.4/0.2	36.61/0.6	PRE316PP
Mobile Socket		0.9/0.4	79.33/1.3	PRE316MP
Flush Socket		0.4/0.2	79.33/1.3	PRE316FP
Wall Socket		1.3/0.6	231.89/3.8	PRE616RP
Plug		0.4/0.2	36.61/0.6	PRE616PP
Mobile Socket		0.9/0.4	79.33/1.3	PRE616MP
Flush Socket		0.4/0.2	79.33/1.3	PRE616FP
20/50 Vdc — White				
Wall Socket		1.3/0.6	231.89/3.8	PRE216RW1
Plug		0.4/0.2	36.61/0.6	PRE216PW1
Mobile Socket		0.9/0.4	79.33/1.3	PRE216MW1
Flush Socket		0.4/0.2	79.33/1.3	PRE216FW1
40/50 Vac 50/60 Hz — White				
Wall Socket		1.3/0.6	231.89/3.8	PRE216RW
Plug		0.4/0.2	36.61/0.6	PRE216PW
Mobile Socket		0.9/0.4	79.33/1.3	PRE216MW
Flush Socket		0.4/0.2	79.33/1.3	PRE216FW
Wall Socket		1.3/0.6	231.89/3.8	PRE616RW
Plug		0.4/0.2	36.61/0.6	PRE616PW
Mobile Socket		0.9/0.4	79.33/1.3	PRE616MW
Flush Socket		0.4/0.2	79.33/1.3	PRE616FW
Low Voltage: LV				
100/130 Vac 50/60 Hz — Yellow				
Wall Socket		1.3/0.6	231.89/3.8	PRE316RY
Plug		0.4/0.2	36.61/0.6	PRE316PY
Mobile Socket		0.9/0.4	79.33/1.3	PRE316MY
Flush Socket		0.4/0.2	79.33/1.3	PRE316FY
200/250 Vac 50/60 Hz — Blue				
Wall Socket		1.3/0.6	231.89/3.8	PRE316RB
Plug		0.4/0.2	36.61/0.6	PRE316PB
Mobile Socket		0.9/0.4	79.33/1.3	PRE316MB
Flush Socket		0.4/0.2	79.33/1.3	PRE316FB

Plugs and Receptacles

PLUGS AND RECEPTACLES: HAZARDOUS LOCATION

A.T.X.[®] PRE Series 16 Amp Plug and Socket Dimensions

Increased Safety

Zone 1 and 2 - 21 and 22
 II 2 GD
 ATEX / IECEx
 IP66 - IK09/10

Dimensions

16A – 2P – 2P+E – 3P Versions

Wall Mounting Sockets

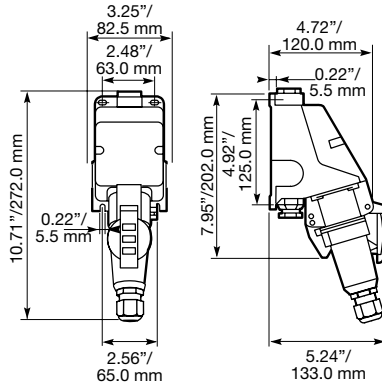

Plugs

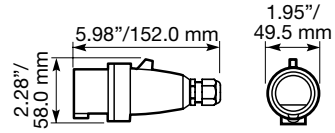

Mobile Sockets

Can be mounted on panel - 0.12"/3.0 mm thickness maximum

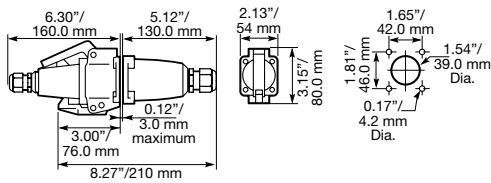

Flush Sockets

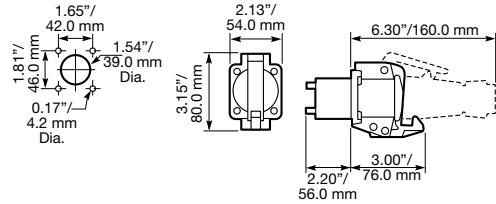

16A – 3P+E – 3P+N+E Versions

Wall Mounting Sockets

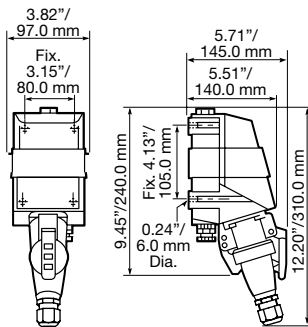

Plugs

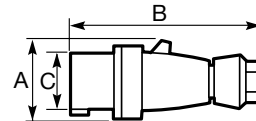

Dimensions in Inches/Millimeters			
	A	B	C
3 P + E	2.60/66.0	6.06/154.0	2.19/55.5
3 P + N + E	2.87/73.0	6.54/166.0	2.44/62.0

Mobile Sockets

Can be mounted on panel - 0.12"/3.0 mm thickness maximum

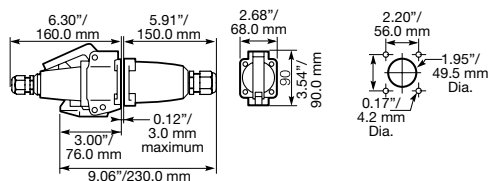

Flush Sockets

