

Mercmaster™ LED Series Luminaires

Enclosed and Gasketed Fixtures

NEC/CEC:

Class I, Division 2, Groups A, B, C, D
Class I, Zone 2, Group IIC
Class II, Division 1, Group E, F, G
Class II, Division 2, Group F, G
Class III

NEC/CEC:

Simultaneous Exposure
Type 3R, 4X
IP66/67
Suitable for Use in Wet Locations
Marine Outside Type (Salt Water)

ATEX/IECEX:

Zone 2 and 22
II 2 GD
IP66/67

Applications

- Enclosed and gasketed fixtures suitable for use in:
 - Marine and wet locations
 - A wide range of industrial, chemical processing and other areas where flammable gases and vapors are present
 - Areas of low clearance, low ceiling heights or where fixture weights must be minimized
 - Non-hazardous locations where severe weather conditions, excessive moisture, dirt, dust, corrosive atmosphere or high ambient temperatures are encountered
- Typical applications include:
 - Pulp and paper mills
 - Processing plants
 - Chemical plants
 - Oil refineries
 - Foundries
 - Manufacturing plants
 - Storage areas
 - Waste and sewage treatment
 - Parking garages
 - Other areas where dust, water, dirt and rough usage are a problem



Features

- Compact light weight low profile design is suited for low mounting heights.
- Modular design allows scores of fixture component combinations to meet installation needs. Uses same mounting hoods as Mercmaster III.
- Fixture housing and mounting hoods are copperfree cast aluminium with baked epoxy finish. All exposed hardware is stainless steel.
- Accommodates a wide range of voltages.
- Ambient temperatures:
 - 70 W to 100 W equivalent: -40 °C to +65 °C (-40 °F to +149 °F)
 - 150 W to 175 W equivalent: -40 °C to +55 °C (-40 °F to +131 °F)
 - 250 W equivalent: -40 °C to +50 °C (-40 °F to +122 °F)
- Electrical: 120-277 Vac, 50/60 Hz; 347-480 Vac, 50/60 Hz, Volts +/- 10%
- Pole terminal block: 1 x 8-24 AWG; 1 x 0.75 to 6 mm² (0.0012 to 0.0093 in²).
- Hinge has high lip for added safety during installation and servicing. Hinge and bolt construction assures 360° compression at all points on ballast housing gasket for positive sealing. Swing away design of captive bolt and nut simplifies servicing.
- All Mercmaster mounting hoods have provision for easy field installation of fuses in fixtures (see Fixture Unit — Electrical Specification).
- NPT and metric threads standard.
- NEMA Type V light distribution is standard. NEMA Type I is available as an option for select NEC/CEC certified fixtures.
- For ATEX/IECEX rated fixtures, ballast bodies and mounting hoods must be purchased separately.

Standard Materials

- Mounting hoods and bodies: cast copperfree (4/10 of 1% max.) aluminium
- All hardware and catch assemblies: stainless steel
- Globe: polycarbonate

Standard Finishes

- Mounting hoods, bodies and guards: baked gray epoxy-clad finish, electrostatically applied for complete uniform protection

NEC/CEC Certifications and Compliances

- UL Standard: UL 1598, UL 1598A, UL 8750, UL 844
- CSA Standard: C22.2 No. 250.0, C22.2 No. 137
- cCSAus Certified: 065182

ATEX/IECEX Certifications and Compliances

- ATEX
 - Gas: Zone 2
 - Conforming to ATEX 94/9/CE: CE 0081 II 3 G
 - ATEX Protection: Ex nA IIC Gc
 - T Rating:
 - 70 W and 100 W equivalent: T4 [+40 °C(+104 °F)], T4 (131 °F/55 °C), T3 [+65 °C (+149 °F)]
 - 150 W to 175 W equivalent: T4 [+40 °C(+104 °F)], T4 [+ 55 °C (+131 °F)]
 - 250 W equivalent: T4 [+40 °C (+104 °F)], T4 [+50 °C (+122 °F)]
 - Dust: Zone 22
 - Conforming to ATEX 94/9/CE: CE 0081 II 3 D
 - ATEX Protection: Ex tc IIIc Dc
 - Surface Temperature: T92 °C (T197.6 °F)
 - Ambient Temperature:
 - 70 W and 100 W equivalent: -40 °C to +65 °C (-40 °F to +149 °F)
 - 150 W to 175 W equivalent: -40 °C to +55 °C (-40 °F to +131 °F)
 - 250 W equivalent: -40 °C to +50 °C (-40 °F to +122 °F)
 - ATEX Certificate: LCIE II ATEX 1008/01
 - Index of Protection: IP66

Mercmaster™ LED Series Luminaires

Enclosed and Gasketed Fixtures

NEC/CEC:

Class I, Division 2, Groups A, B, C, D
Class I, Zone 2, Group IIC
Class II, Division 1, Group E, F, G
Class II, Division 2, Group F, G
Class III

NEC/CEC:

Simultaneous Exposure
Type 3R, 4X
IP66/67
Suitable for Use in Wet Locations
Marine Outside Type (Salt Water)

ATEX/IECEX:

Zone 2 and 22
Ex II 2 GD
IP66/67

Illustrated Features



Heatsink

Reliable heat transfer via the cast, epoxy powder coat aluminium body. Provides maximum heat dissipation from the LED assembly to the outside environment.



Driver Assembly

Utilizing non-sparking components avoiding the ignition of gases or vapors that may be present (nA).

Modular Plug between LED and driver.



LED Chamber

Protected by polycarbonate lens, allows for easy maintenance access.

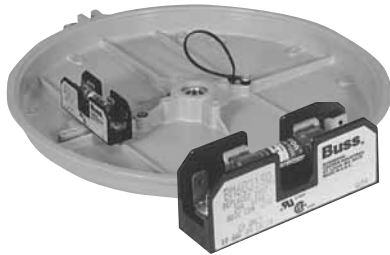

Fuses

Two screws secure fuse kit to mounting boss in any Mercmaster mounting hood. Fuse included.

Photocell

Available for all fixtures except cone and ceiling mount. Installs through knock-out in mounting hood. Provides continuous ON-OFF dusk-to-dawn control.

Terminal Blocks (Zone 2)

A seven-point terminal block is provided to facilitate wiring. Terminal block accommodates wire size ranging from #8 to #24AWG, 0.75 to 6 mm² (0.0012 to 0.0093 in²)

Epoxy Finish

Ballast housing, hoods and guards are copperfree aluminium with epoxy powder coat finish.

Electrical Protection

Ground wire provided to bond mounting hood to ballast housing.

Safety

Rounded heatsink edges prevent possible injury during installation.



Cooler Operating Cone Hood

Larger sloped surface sheds dusts, dirt and combustible fibers providing better heat dissipation.

Mounting Hood and Globe Gaskets

Silicone rubber gaskets seals out moisture, dirt and dust. Stays flexible, withstands high temperatures. Closure design assures uniform gasket compression.



"Safety" High Hinge

Extra-high hinge provides additional protection against accidental ballast housing disengagement during installation or maintenance.

Stainless Steel Latch Assembly

Captive, stainless steel latch assembly bolt and nut closes securely, resists attack of corrosive atmospheres. Swing-away design simplifies servicing.



Mercmaster™ LED Series Luminaires

Enclosed and Gasketed Fixtures

NEC/CEC:

Class I, Division 2, Groups A, B, C, D
 Class I, Zone 2, Group IIC
 Class II, Division 1, Group E, F, G
 Class II, Division 2, Group F, G
 Class III

NEC/CEC:

Simultaneous Exposure
 Type 3R, 4X
 IP66/67
 Suitable for Use in Wet Locations
 Marine Outside Type (Salt Water)

ATEX/IECEX:

Zone 2 and 22
 II 2 GD
 IP66/67

Order using catalog numbering guides below or select catalog number from tables on following pages.

Catalog Numbering Guide – NEC/CEC Certified Mercmaster LED

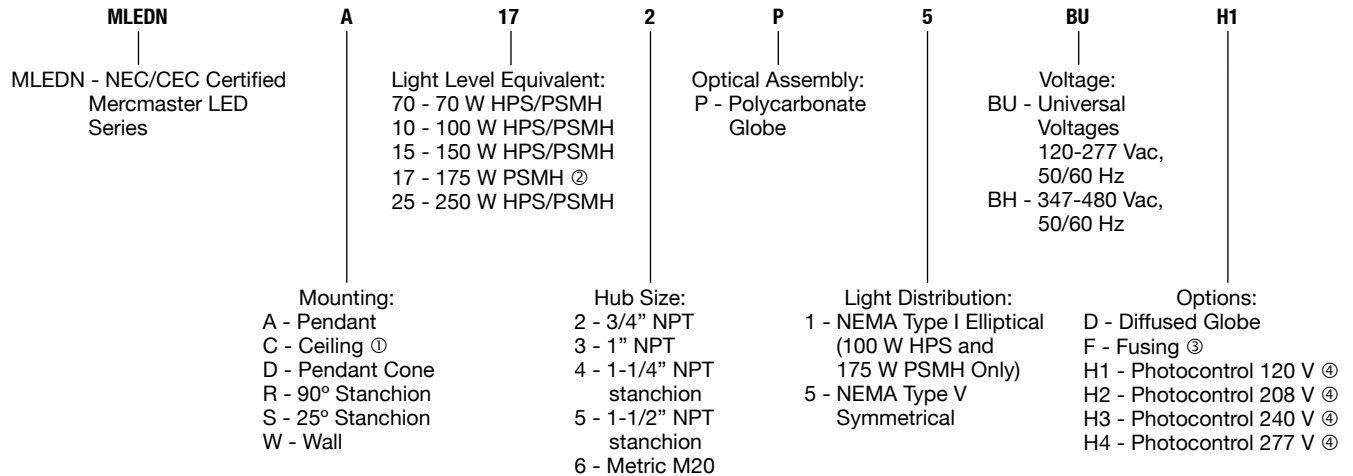

Catalog Numbering Guide – ATEX/IECEX Certified Mercmaster LED ⑤

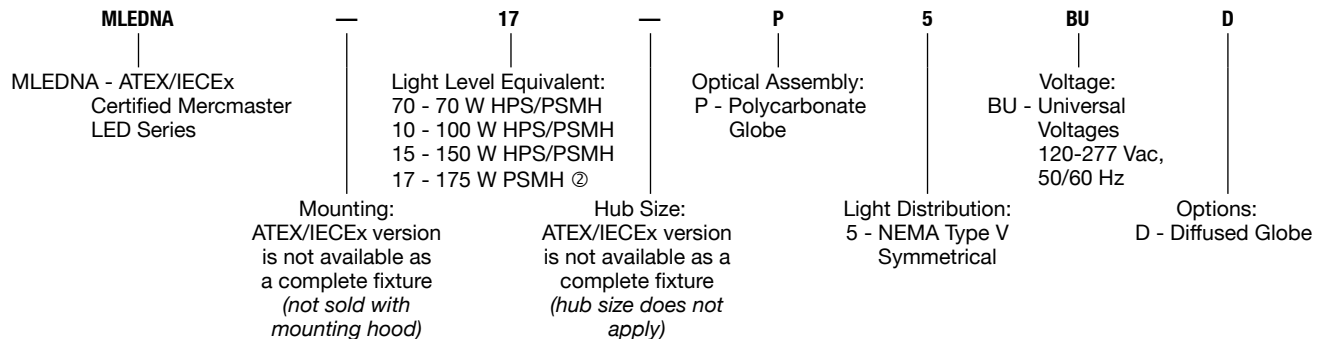

① Ceiling mount luminaires are not designed to use the PCD2 photocontrol. Ceiling mounts must use an FS/FD box with a photocontrol. Contact your local sales representative for more information.
 ② 175 W Pulse Start Metal Halide only. Does not have a High Pressure Sodium equivalent.
 ③ Canadian Electrical Code does NOT allow fusing in hazardous locations ✖. Fuse not CEC rated.
 ④ Luminaires with photocontrol are not rated IP66/67 or marine outside type (salt water).
 ⑤ For ATEX/IECEX rated fixtures, ballast bodies and mounting hoods must be purchased separately.

Mercmaster™ LED Series Luminaires

Enclosed and Gasketed Fixtures

NEC/CEC:
 Class I, Division 2, Groups A, B, C, D
 Class I, Zone 2, Group IIC
 Class II, Division 1, Group E, F, G
 Class II, Division 2, Group F, G
 Class III

NEC/CEC:
 Simultaneous Exposure
 Type 3R, 4X
 IP66/67
 Suitable for Use in Wet Locations
 Marine Outside Type (Salt Water)

ATEX/IECEX:
 Zone 2 and 22
 II 2 GD
 IP66/67

Technical Data

Lamp		Ambient Temperature °C (°F)	Supply Wire Temperature °C (°F)	NEC/CEC					Gas/Dust Simultaneous ① Class I, Division 2/ Class II, Division 1	ATEX/IECEX	
Light Level Equivalent to HID	Type			Class I, Division 2 ①	Gas Groups	Class I, Zone 2, AEx nA IIC, Ex nA IIC	Class II, Division 1 and 2 ②	Dust Groups		Gas Ex II 3G ① nA	Dust Ex II 3D ② Ex tc IIIC
70 Watt NEMA Type V	LED	40 (104)	60 (140)	T4A		T4	T6		T4	T4	T92°C (T197.6°F) DC
		55 (131)	75 (167)	T4	A, B, C, D	T4	T6	E, F, G	T4	T4	
		65 (143)	90 (194)	T3C		T3	T6		T3C	T4	
100 Watt NEMA Type V	LED	40 (104)	60 (140)	T4A		T4	T6		T4	T4	T92°C (T197.6°F) DC
		55 (131)	75 (167)	T4	A, B, C, D	T4	T6	E, F, G	T4	T4	
		65 (143)	90 (194)	T3C		T3	T6		T3C	T4	
100 Watt NEMA Type I	LED	40 (104)	60 (140)	T4		T4	—		—	—	—
		75 (167)	75 (167)	T3C	A, B, C, D	T3	—	E, F, G	—	—	
		90 (194)	90 (194)	T3C		T3	—		—	—	
150 Watt NEMA Type V	LED	40 (104)	60 (140)	T4A		T4	T6		T4	T6	T92°C (T197.6°F) DC IP66
		55 (131)	75 (167)	T4	A, B, C, D	T4	T6	E, F, G	T4	T6	
175 Watt NEMA Type V	LED	40 (104)	60 (140)	T4A		T4	T6		T4	T6	T92°C (T197.6°F) DC IP66
		55 (131)	75 (167)	T4	A, B, C, D	T4	T6	E, F, G	T4	T6	
175 Watt NEMA Type I	LED	40 (104)	60 (140)	T4		T4	T5		T4	—	—
		55 (131)	75 (167)	T3C	A, B, C, D	T3	T5	E, F, G	T3C	—	
250 Watt NEMA Type V	LED	40 (104)	60 (140)	T4A		T4	T6		T4A	—	—
		50 (122)	75 (167)	T4	A, B, C, D	T4	T6	E, F, G	T4	—	

“T” Numbers Represent the Maximum Internal Temperature ① or Maximum Surface Temperature ②

“T” #	NEC/CEC															
	T1	350	325	T2	T2A	T2B	T2C	T2D	T3	T3A	T3B	T3C	T4	T4A	T5	T6
Temp. Range °C (°F)	351-450 (664-842)	326-350 (619-662)	301-325 (574-617)	281-300 (538-572)	261-280 (502-536)	231-260 (448-500)	216-230 (421-446)	201-215 (394-419)	181-200 (358-392)	166-180 (331-356)	161-165 (322-329)	136-160 (277-320)	121-135 (250-275)	101-120 (214-248)	86-100 (187-212)	85 (185)

“T” #	ATEX/IECEX					
	T1	T2	T3	T4	T5	T6
Temp. Range °C (°F)	301-450 (547-842)	201-300 (394-572)	136-200 (277-392)	101-135 (214-275)	86-100 (187-212)	85 (185)

① T numbers represent the maximum internal temperature for Class I, Division 2 and Class I, Zone 2 locations designated by the NEC.

② T numbers represent the maximum surface temperature under a dust blanket for Class II, Division 1 and Class I, Zone 2 as designated by the NEC or Zone 2 (Gas) and 22 (Dust) locations as designated by the IEC.

Mercmaster™ LED Series Luminaires

Enclosed and Gasketed Fixtures

NEC/CEC:

Class I, Division 2, Groups A, B, C, D
 Class I, Zone 2, Group IIC
 Class II, Division 1, Group E, F, G
 Class II, Division 2, Group F, G
 Class III

NEC/CEC:

Simultaneous Exposure
 Type 3R, 4X
 IP66/67
 Suitable for Use in Wet Locations
 Marine Outside Type (Salt Water)

ATEX/IECEX:

Zone 2 and 22
 II 2 GD
 IP66/67

Lamp Comparison Chart

Lamp Data	Line Current Amps	Input Power	Lumens	CRI	Lamp Life (Hours)	Color Temp CCT
NEMA Type V						
MLEDN70	.31 @ 120 V	35	2300	70	60,000+	5650
	.17 @ 277 V	33				
MLEDN100	.41 @ 120 V	47.5	3450	70	60,000+	5650
	.20 @ 277 V	46				
MLEDN150	.53 @ 120 V	61	4850	70	60,000+	5650
	.25 @ 277 V	62				
MLEDN175	.63 @ 120 V	74	6076	70	60,000+	5650
	.28 @ 277 V	72				
MLEDN250	.83 @ 120 V	95.5	9455	70	60,000+	5650
	.36 @ 277 V	92				
NEMA Type I						
MLEDN100	.41 @ 120 V	46.7	2900	70	60,000+	5650
	.20 @ 277 V	46.6				
MLEDN175	.61 @ 120 V	70	6200	70	60,000+	5650
	.28 @ 277 V	69				

Mercmaster LED Ballast and Mounting Hood Weights

Description	Weight kg (lb)
Fixture Unit (Ballast Housing)	8.8 (19.4)
Pendant Mounting Hood	1.0 (2.25)
Pendant Cone Mounting Hood	1.1 (2.50)
Ceiling Mounting Hood	1.4 (3.00)
Wall Mounting Hood	1.8 (4.00)
25° Stanchion Mounting Hood	1.5 (3.25)
90° Stanchion Mounting Hood	1.7 (3.75)

Lighting



LIGHTING: ENCLOSED AND GASKETED – AREA – LED/INDUCTION

Mercmaster™ LED Series Luminaires

Enclosed and Gasketed Fixtures

NEC/CEC:
 Class I, Division 2, Groups A, B, C, D
 Class I, Zone 2, Group IIC
 Class II, Division 1, Group E, F, G
 Class II, Division 2, Group F, G
 Class III

NEC/CEC:
 Simultaneous Exposure
 Type 3R, 4X
 IP66/67
 Suitable for Use in Wet Locations
 Marine Outside Type (Salt Water)

	LED Wattage BU/BH	Lamp Wattage Equivalent	NEMA Type	Hub Size	Conformance	Catalog Numbers ①
25° Stanchion — One Hub						
	35/33 W	70 W HPS/PSMH	Type V	1-1/4	NEC/CEC	MLEDNS704P5
	47.5/46 W	100 W HPS/PSMH	Type V	1-1/4	NEC/CEC	MLEDNS104P5
	46.7/46.6 W	100 W HPS/PSMH	Type I	1-1/4	NEC/CEC	MLEDNS104P1 ②
	61/62 W	150 W HPS/PSMH	Type V	1-1/4	NEC/CEC	MLEDNS154P5
	74/72 W	175 W PSMH	Type V	1-1/4	NEC/CEC	MLEDNS174P5
	70/64 W	175 W PSMH	Type I	1-1/4	NEC/CEC	MLEDNS174P1 ②
	95.5/92 W	250 W HPS/PSMH	Type V	1-1/4	NEC/CEC	MLEDNS254P5
	35/33 W	70 W HPS/PSMH	Type V	1-1/2	NEC/CEC	MLEDNS705P5
	47.5/46 W	100 W HPS/PSMH	Type V	1-1/2	NEC/CEC	MLEDNS105P5
	46.7/46.6 W	100 W HPS/PSMH	Type I	1-1/2	NEC/CEC	MLEDNS105P1 ②
	61/62 W	150 W HPS/PSMH	Type V	1-1/2	NEC/CEC	MLEDNS155P5
	74/72 W	175 W PSMH	Type V	1-1/2	NEC/CEC	MLEDNS175P5
	70/64 W	175 W PSMH	Type I	1-1/2	NEC/CEC	MLEDNS175P1 ②
	95.5/92 W	250 W HPS/PSMH	Type V	1-1/2	NEC/CEC	MLEDNS255P5
90° Stanchion — One Hub						
	35/33 W	70 W HPS/PSMH	Type V	1-1/4	NEC/CEC	MLEDNR704P5
	47.5/46 W	100 W HPS/PSMH	Type V	1-1/4	NEC/CEC	MLEDNR104P5
	46.7/46.6 W	100 W HPS/PSMH	Type I	1-1/4	NEC/CEC	MLEDNR104P1 ②
	61/62 W	150 W HPS/PSMH	Type V	1-1/4	NEC/CEC	MLEDNR154P5
	74/72 W	175 W PSMH	Type V	1-1/4	NEC/CEC	MLEDNR174P5
	70/64 W	175 W PSMH	Type I	1-1/4	NEC/CEC	MLEDNR174P1 ②
	95.5/92 W	250 W HPS/PSMH	Type V	1-1/4	NEC/CEC	MLEDNR254P5
	35/33 W	70 W HPS/PSMH	Type V	1-1/2	NEC/CEC	MLEDNR705P5
	47.5/46 W	100 W HPS/PSMH	Type V	1-1/2	NEC/CEC	MLEDNR105P5
	46.7/46.6 W	100 W HPS/PSMH	Type I	1-1/2	NEC/CEC	MLEDNR105P1 ②
	61/62 W	150 W HPS/PSMH	Type V	1-1/2	NEC/CEC	MLEDNR155P5
	74/72 W	175 W PSMH	Type V	1-1/2	NEC/CEC	MLEDNR175P5
	70/64 W	175 W PSMH	Type I	1-1/2	NEC/CEC	MLEDNR175P1 ②
	95.5/92 W	250 W HPS/PSMH	Type V	1-1/2	NEC/CEC	MLEDNR255P5

① Suffix Voltage AC Frequency
BU 120 - 277 50/60 Hz
BH 347 - 480 50/60 Hz

② NEMA Type I Elliptical.

Mercmaster™ LED Series Luminaires

Enclosed and Gasketed Fixtures

Dimensions in Millimeters (Inches)

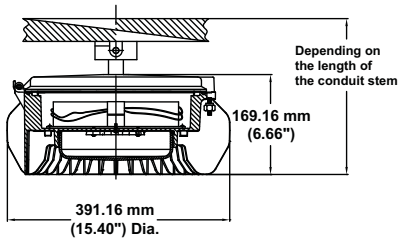

Pendant Mount

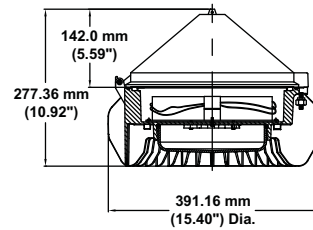

Pendant Cone Mount

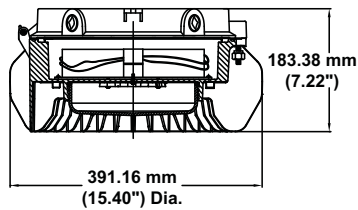

Ceiling Mount

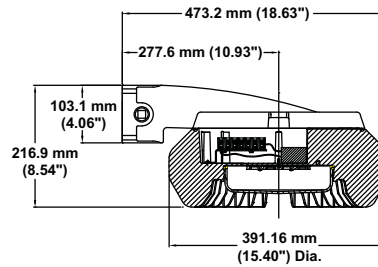

Wall Mount

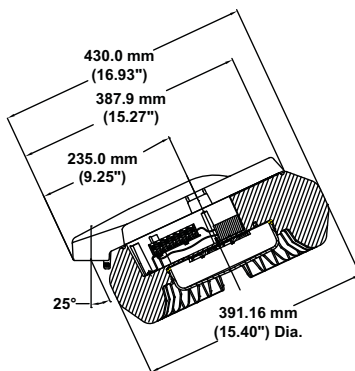

25° Stanchion Mount

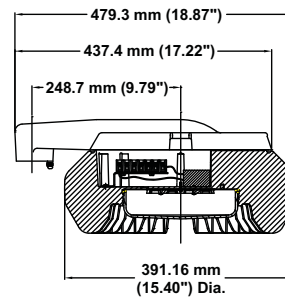

90° Stanchion Mount