

Quartzlite™ Floodlights

For 300W thru 1500W quartz tungsten halogen lamps.

Ordering Information

(Illumination based on use of T-3 Quartz tungsten Halogen lamps)

Description	NEMA Type	Beam Spread		Lumens	Candlepower		Catalog Number		
		Horiz.	Vert.		Max.	Avg. Max.	With Lamp	Without Lamp	
Quartzlite™ 1500									
Wide Beam	6 x 6	128.0°	103.0°	23,218	18,689	17,564	G-1500-5-L240 ❶ G-1500-5-L277 ❷	G-1500-5 ❸ —	
Quartzlite™ 500									
Wide	5 x 5	95°	92°	6,846	8,416	7,685	G-500-5-L130 ❹	G-500-5 ❺	

❶ Furnished with 1500W lamps for 240-volt line operation. ❷ Furnished with 1500W lamps for 277-volt line operation. ❸ For 1500W lamps for 208, 220, 240 or 277-volt line operation; 1250W lamps for 208-volt line operation; 1000W lamps for 220 or 240-volt line operation. ❹ Furnished with 500W lamps for 120 or 130-volt line operation. ❺ For 300W or 500W lamps for 120 or 130-volt line operation.

Mounting Fittings and Accessories

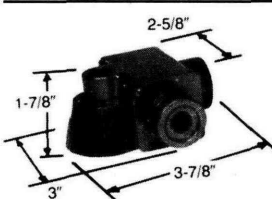
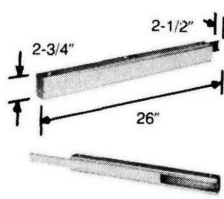
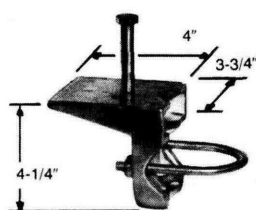
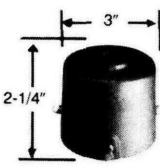
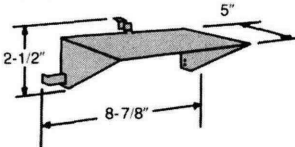
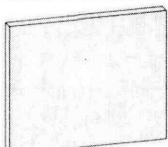
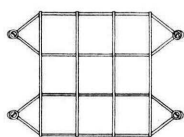
Dimensions	Description	Cat. No.	Dimensions	Description	Cat. No.
	Crossarm Mount and Wiring Compartment 180° horizontal position scale, mounts with bolt (not furnished). Aluminum with architectural bronze POLYESTER finish. Includes cord grip.	G-6028N		Channel Crossarm Extruded aluminum, with slide-off cover. Has six 3/4" threaded holes, with three close-up plugs. Mounts five 500W or four 1500W Quartzlites. Mounts on 3/4" conduit or G-810 poletop fitter.	G-6017
	Pipe or Wall Mount Bracket Mounts on 1" to 2" pipe, vertical or horizontal, or mounts on flat surfaces (used with G-6028N). Includes U-bolts and bolt for G-6028N. Malleable iron, zinc plated, chromate sealed, architectural bronze POLYESTER finish.	G-VB101		Poletop Fitter Cast aluminum, for mounting to 1-1/2" or 2" pipe. Has setscrews for securing to pole, 3/4" tapped top hub to accommodate Quartzlite or Channel Crossarm above. Architectural bronze POLYESTER finish.	G-810
	Top Visor 500W	GMM4V		Replacement Lens 500W 1500W	601252002 601252001
	Wire Guard 500W	G-506	Replacement Lens Frame Assembly (Complete with Lens) 500W G5005RFL 1500W G1500RFL Replacement Socket Assembly (Pair) 500W G5005RS 1500W G1500RS		

Quartzlite™ Floodlights

For 300W thru 1500W quartz tungsten halogen lamps.

Applications

- Heavy duty, weatherproof floodlights for industrial, commercial, and sports applications where efficient, controlled distribution is required. Widely used for sports and amusement areas, sign lighting, parking lots, accent lighting, security lighting and similar applications.

Features

- Choice of mounting fittings and accessories to meet installation needs.
- Rugged, compact, lightweight design; easy to install and maintain. Cool operating, long lamp life.
- Quartzlite 500 uses 500W or 300W 120V or 130V T-3 quartz tungsten halogen lamps with exceptional efficiency and economy.
- Quartzlite 1500 uses T-3 quartz tungsten halogen lamps. Available for use with 1500W lamps for 208V, 220V, 240V, and 277V operation; for 1250W lamps, 208V operation; and for 1000W lamps, 220V or 240V operation.
- Housing and lens door: rugged, corrosion resistant, one-piece pressure-cast aluminum, with architectural bronze POLYESTER finish. 1500W unit housing has integral fins for maximum heat dissipation. Patented hinged door has thermal shock and impact resistant glass lens. Secures with two 5/16" captive stainless steel hex-head bolts.
- Gasket: heavy, one-piece silicone rubber to resist high temperatures. Completely seals unit, assures weather-proof installation.
- Reflector: precision parabolic design, Alzak® finished aluminum for maximum efficiency.
- Mounting arm: heavy duty, degree-marked swivel mounting arm with 3/4" pipe thread and locknut.

Compliances

- UL Listed.
- UL Standard 1598 (supersedes UL Standards 1571).

Projected Area:
1.2 Sq. Ft.

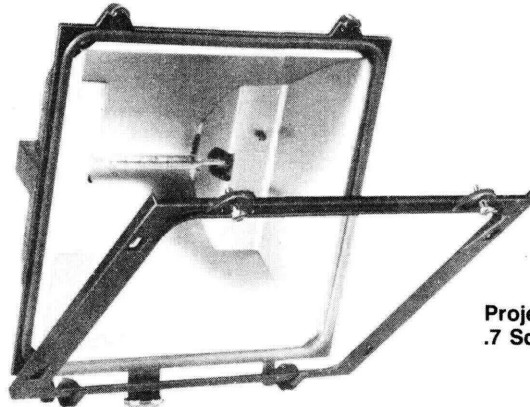
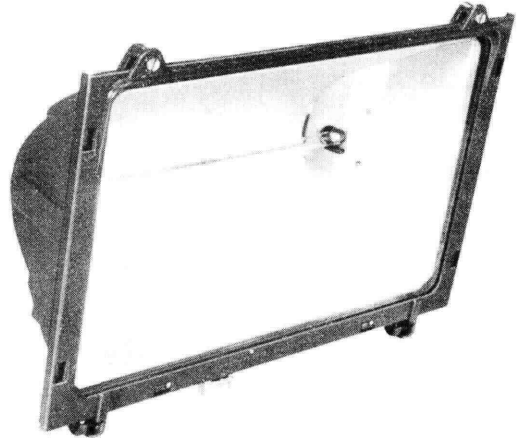

Projected Area:
.7 Sq. Ft.

Quartzlite™ 500

Quartzlite™ 1500

